

<p>10 sek 1 serie</p> 	<p>2.56s 9.3 ←</p> <p>4.40s 7.6 ←</p> <p>5.60s 8.1 ↘</p> <p>6.80s 9.4 ←</p> <p>7.71s 9.8 ↑</p> <p>3.25s 5.2 ←</p> <p>4.72s 5.6 ←</p> <p>6.26s 9.3 ↗</p> <p>7.48s 7.9 ↙</p> <p>8.76s 8.4 ↙</p> <p><b>Serie 76 ( 0x)</b></p> <p><b>Total 76 ( 0x)</b></p>	<p>10 sek 2 serie</p>  <p>2.95s 7.4 ↖</p> <p>4.25s 9.8 ↗</p> <p>3.03s 7.3 ↖</p> <p>5.59s 8.4 ↗</p> <p>7.91s 8.2 ↖</p> <p>2.74s 8.6 ↖</p> <p>4.58s 8.2 ←</p> <p>5.99s 10.4x ←</p> <p>7.41s 10.2 ↑</p> <p>8.65s 8.6 ↖</p> <p><b>Serie 83 ( 1x)</b></p> <p><b>Total 159 ( 1x)</b></p>
---	---	--

<p>8 sek 1 serie</p> 	<p>2.54s 9.8 ↑</p> <p>3.95s 9.8 ↑</p> <p>5.09s 9.7 ↓</p> <p>6.06s 10.3 ↑</p> <p>7.27s 10.1 ←</p> <p>3.18s 9.0 ↗</p> <p>4.53s 9.5 ↓</p> <p>5.56s 9.6 →</p> <p>6.59s 10.3 ↗</p> <p>7.83s 9.6 ↓</p> <p><b>Serie 93 ( 0x)</b></p> <p><b>Total 252 ( 1x)</b></p>	<p>8 sek 2 serie</p>  <p>2.14s 7.9 ↘</p> <p>3.52s 8.1 ←</p> <p>4.94s 9.2 →</p> <p>6.14s 10.0 ↓</p> <p>7.27s 8.6 ↘</p> <p>2.29s 7.9 ↙</p> <p>4.01s 8.8 ↙</p> <p>5.03s 10.5x ↗</p> <p>6.17s 9.2 ↓</p> <p>7.05s 8.9 →</p> <p><b>Serie 84 ( 1x)</b></p> <p><b>Total 336 ( 2x)</b></p>
--	---	--

<p>6 sek 1 serie</p> 	<p>1.72s 10.3 ↘</p> <p>2.61s 8.4 ↘</p> <p>3.46s 10.5x ←</p> <p>4.32s 9.7 ↙</p> <p>5.20s 10.3 ↗</p> <p>2.34s 8.1 ↑</p> <p>3.09s 9.9 ↗</p> <p>3.90s 9.1 ↓</p> <p>4.66s 10.1 ↘</p> <p>5.47s 9.5 ↓</p> <p><b>Serie 92 ( 1x)</b></p> <p><b>Total 428 ( 3x)</b></p>	<p>6 sek 2 serie</p>  <p>2.15s 6.5 ↙</p> <p>2.97s 9.7 ↖</p> <p>3.92s 7.4 ←</p> <p>4.72s 7.3 ↑</p> <p>5.69s 9.5 ↖</p> <p>2.52s 8.4 ←</p> <p>3.24s 10.4 ↗</p> <p>3.95s 9.4 ↓</p> <p>4.66s 10.3 →</p> <p>5.47s 9.0 ↘</p> <p><b>Serie 84 ( 0x)</b></p> <p><b>Total 512 ( 3x)</b></p>
---	---	--

Lag	Skive	Are Wivestad	
1	2		
Hurtigpistol Grov		Sola PK	V55
25.06.2019		NM bane 2019	NM Pistol 2019
10 sek 1 serie		3.59s 10.5x ↘ 4.88s 9.8 ↖ 5.90s 10.2 ↘ 7.20s 7.9 ↓ 8.40s 8.8 → 2.92s 9.8 ↑ 4.34s 10.3 ← 5.49s 9.0 ↓ 6.62s 10.3 ↗ 7.82s 9.5 ↗ Serie 91 ( 1x) Total 91 ( 1x)	10 sek 2 serie  2.54s 7.4 ↗ 4.42s 8.8 ↖ 5.85s 10.1 ↗ 7.22s 9.9 ↑ 8.65s 10.3 → 2.36s 10.7x ↘ 4.01s 9.1 → 5.14s 10.1 ← 6.36s 10.6x ↖ 7.73s 9.2 ← Serie 92 ( 2x) Total 183 ( 3x)
8 sek 1 serie		2.24s 10.4x ↘ 3.32s 10.3 ↖ 4.37s 10.3 → 5.30s 10.8x ↑ 6.70s 10.8x ↑ 2.31s 7.9 ↘ 4.38s 8.7 ↗ 5.46s 9.9 ← 6.30s 9.0 ← 7.54s 10.7x ↙ Serie 93 ( 4x) Total 276 ( 7x)	8 sek 2 serie  2.16s 10.2 ↑ 3.72s 8.5 ← 4.78s 8.2 ↓ 5.86s 8.3 ↘ 7.02s 10.0 ↘ 2.11s 10.6x ↘ 3.18s 7.5 ↓ 4.23s 10.8x ↙ 5.37s 8.1 ← 6.41s 9.2 ↓ Serie 88 ( 2x) Total 364 ( 9x)
6 sek 1 serie		2.52s 6.9 ↓ 3.42s 10.3 ↖ 4.11s 10.5x ↗ 4.93s 10.6x ↑ 5.86s 10.3 ↓ 1.81s 9.1 ← 2.71s 9.8 ↑ 3.50s 9.8 ↓ 4.24s 10.5x ↘ 5.25s 10.3 ← Serie 93 ( 3x) Total 457 ( 12x)	6 sek 2 serie  2.04s 10.0 ↖ 3.15s 7.0 ← 4.17s 9.3 ↗ 5.18s 9.2 ↑ 6.00s 10.2 ↘ 1.87s 9.0 ↓ 2.96s 8.8 ← 3.74s 9.3 → 4.63s 10.3 ↘ 5.47s 10.7x → Serie 91 ( 1x) Total 548 ( 13x)

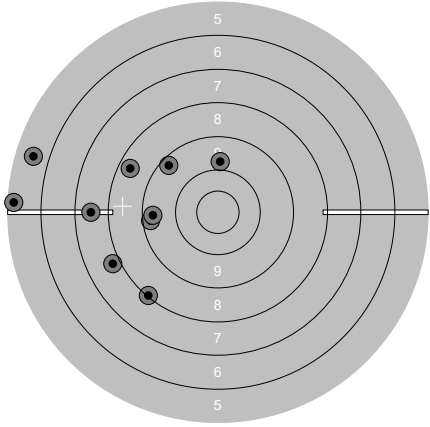
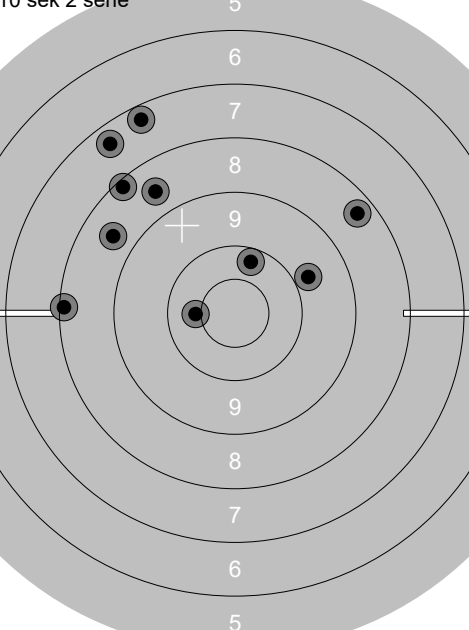
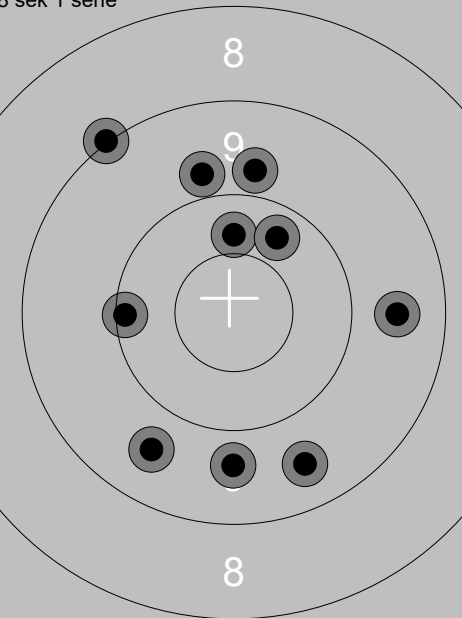
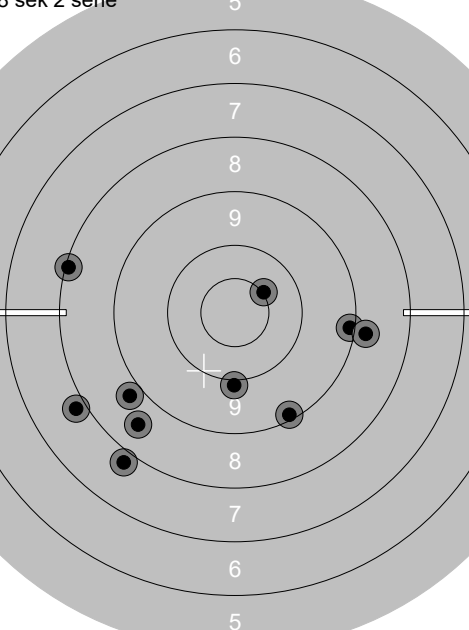
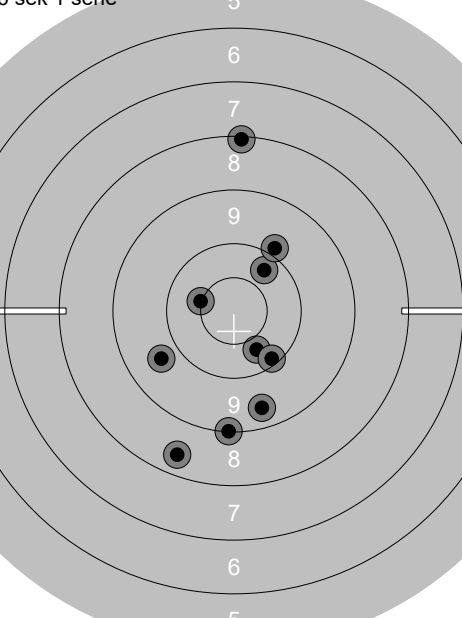
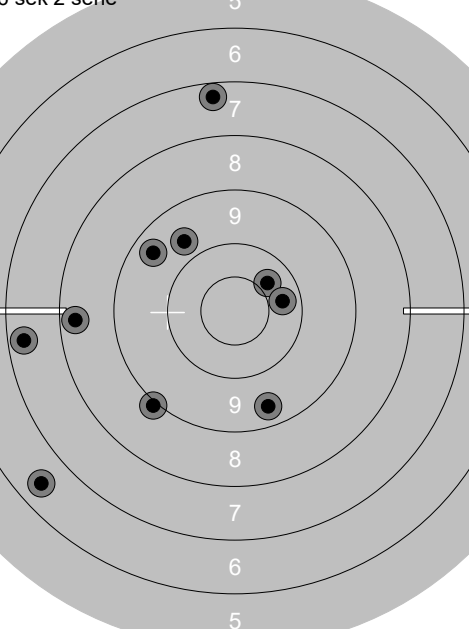
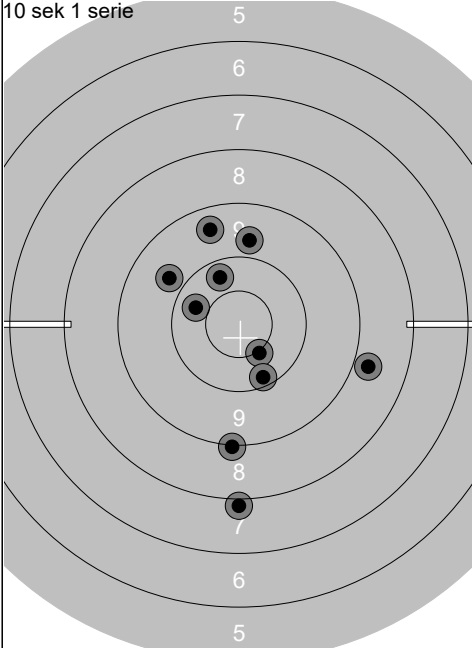
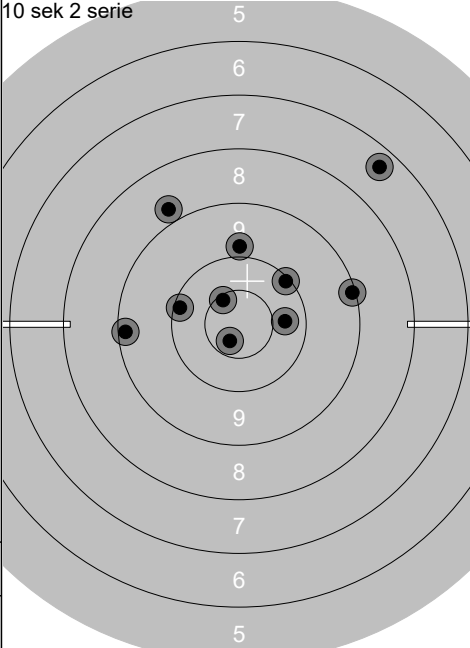
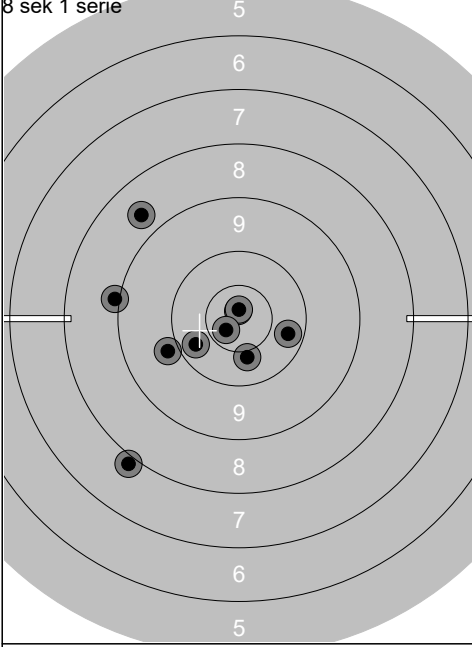
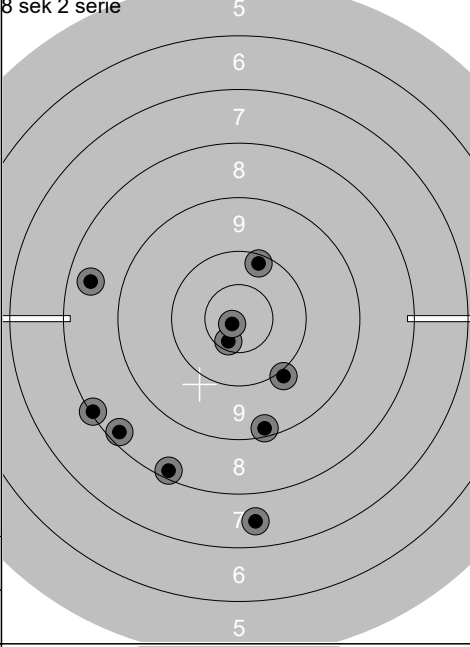
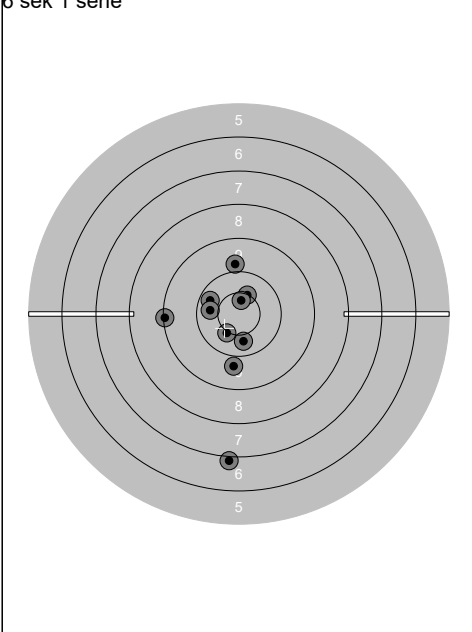
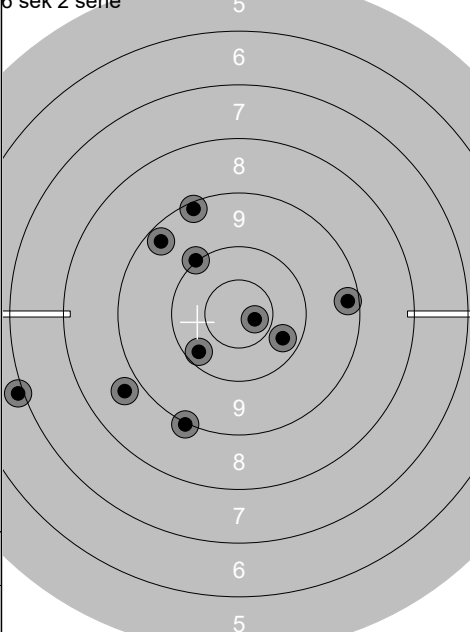
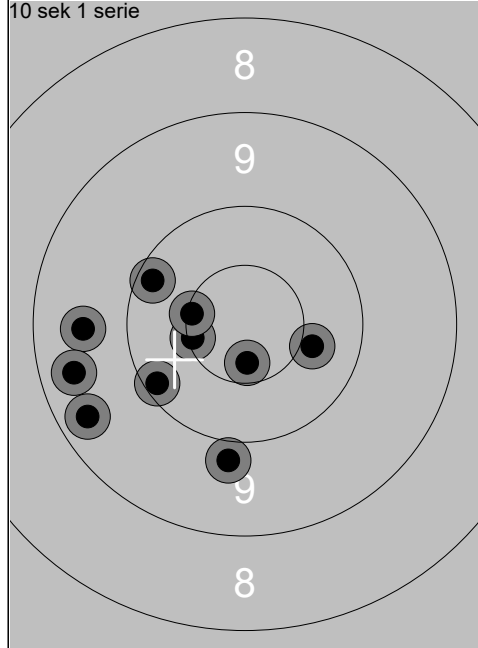

2.33s	10.2	↖
3.46s	9.4	↙
4.71s	10.5x	↙
5.86s	10.4	→
7.06s	10.7x	↓
2.70s	9.9	↓
4.22s	10.1	↙
5.49s	10.5x	↙
6.84s	9.6	←
8.06s	9.4	←
<b>Serie</b>	<b>96 ( 3x)</b>	
<b>Total</b>	<b>96 ( 3x)</b>	

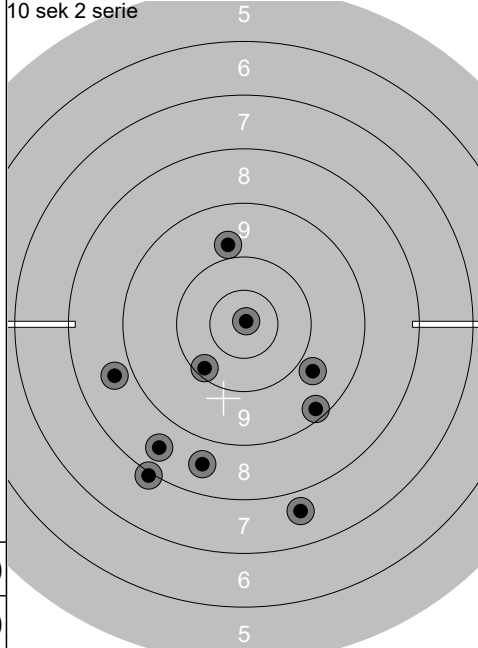

2.62s	9.8	↑
4.13s	10.2	↙
5.38s	8.6	↓
6.79s	10.9x	↗
8.09s	8.0	↙
2.29s	9.3	↘
3.75s	9.8	↘
5.05s	8.6	↙
6.40s	8.7	←
7.66s	7.7	↓
<b>Serie</b>	<b>86 ( 1x)</b>	
<b>Total</b>	<b>182 ( 4x)</b>	

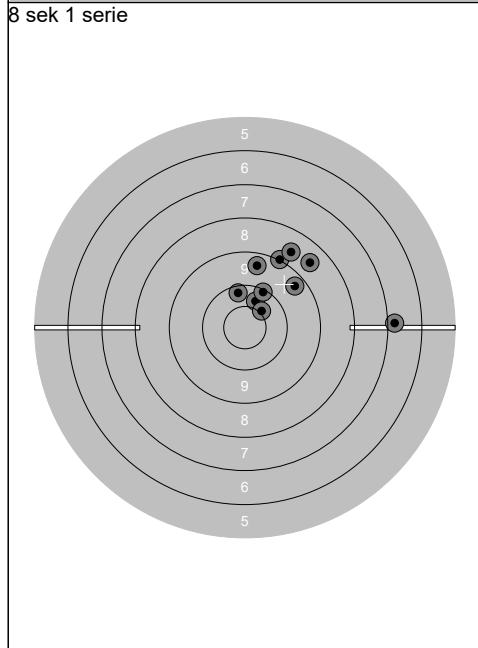

2.68s	8.6	↗
3.90s	10.3	↑
4.91s	9.0	↑
5.84s	8.7	↗
6.96s	10.1	↑
2.14s	10.2	↑
3.45s	6.9	→
4.61s	9.4	↑
5.82s	9.4	↗
7.10s	10.4x	↗
<b>Serie</b>	<b>89 ( 1x)</b>	
<b>Total</b>	<b>271 ( 5x)</b>	

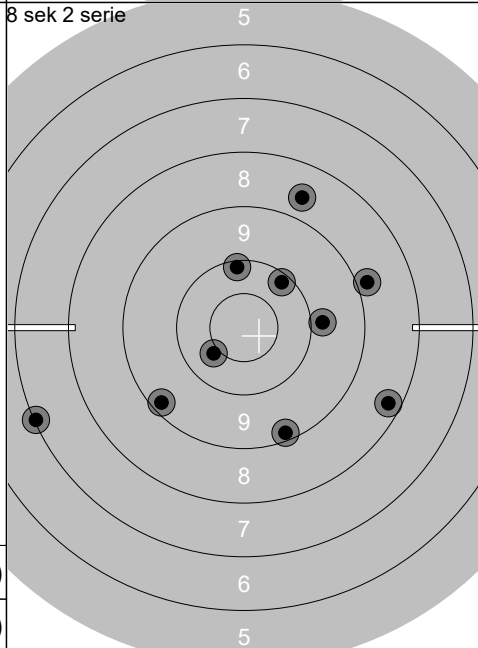

2.33s	8.9	→
3.51s	8.3	↘
4.75s	9.2	↓
3.42s	10.1	↗
4.73s	7.1	←
2.27s	10.4x	↙
3.56s	10.1	↑
4.71s	9.9	→
5.75s	8.7	↗
6.89s	9.3	↙
<b>Serie</b>	<b>88 ( 1x)</b>	
<b>Total</b>	<b>359 ( 6x)</b>	

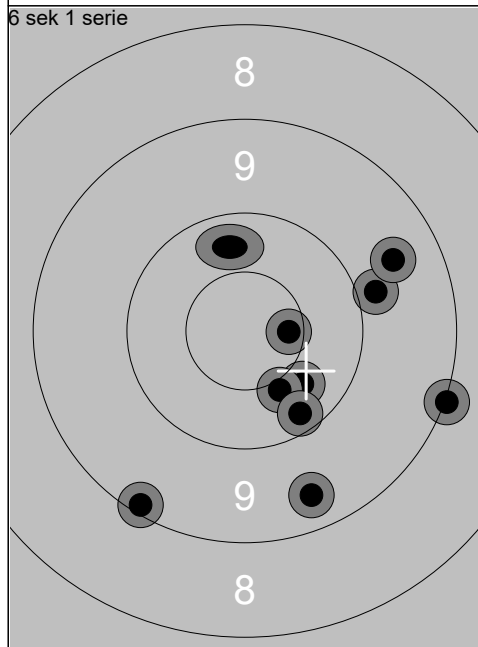

1.96s	9.9	→
2.99s	10.3	↘
3.95s	9.2	↙
4.90s	9.6	↗
5.82s	10.4x	↘
2.33s	10.6x	→
3.39s	9.1	→
4.46s	10.2	↘
5.48s	9.4	↘
0.07s		↙
<b>Serie</b>	<b>85 ( 2x)</b>	
<b>Total</b>	<b>444 ( 8x)</b>	

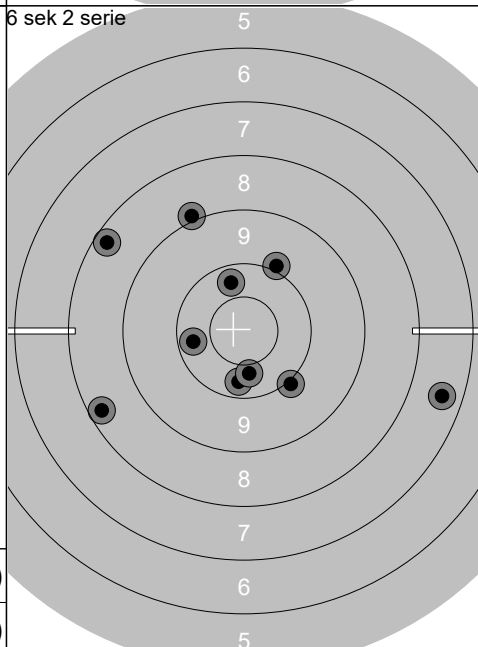

2.19s	10.0	↗
3.27s	7.5	→
4.37s	10.3	↓
5.08s	10.3	←
5.86s	10.3	↑
2.49s	9.0	↗
3.29s	8.3	↙
4.17s	10.4	↓
4.97s	8.3	←
5.93s	10.0	↘
<b>Serie</b>	<b>92 ( 0x)</b>	
<b>Total</b>	<b>536 ( 8x)</b>	

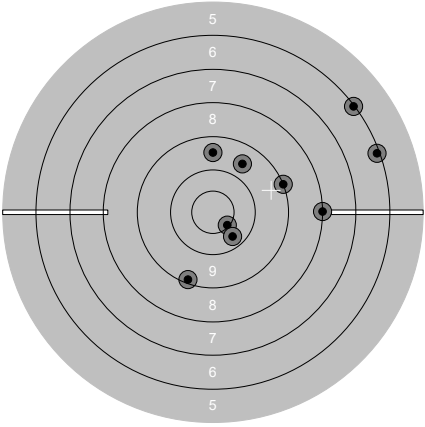
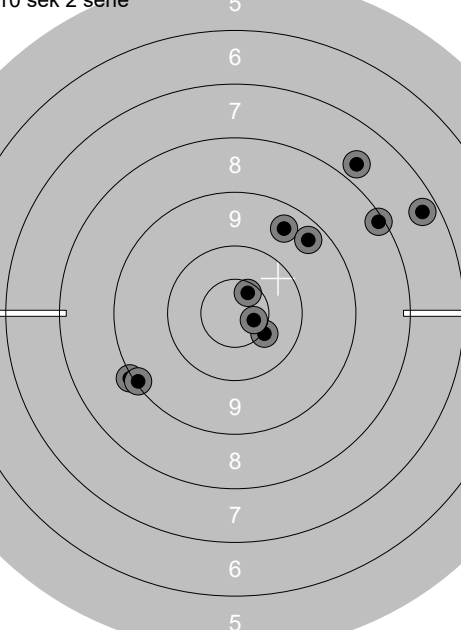
<p>10 sek 1 serie</p> 	<p>3.67s 6.1 →</p> <p>5.05s 6.1 ↗</p> <p>6.49s 9.6 ↗</p> <p>7.39s 10.5x ↘</p> <p>8.52s 10.3 ↘</p> <p>3.38s 9.1 →</p> <p>5.13s 9.6 ↑</p> <p>6.28s 8.1 →</p> <p>7.41s 9.2 ↓</p> <p style="text-align: center;">--</p> <p>Serie 76 ( 1x)</p> <p>Total 76 ( 1x)</p>	<p>10 sek 2 serie</p> 	<p>3.30s 7.8 ↗</p> <p>4.57s 9.5 ↗</p> <p>5.73s 7.4 →</p> <p>6.69s 10.6x ↗</p> <p>7.94s 9.0 ←</p> <p>3.66s 8.2 ↗</p> <p>5.24s 9.4 ↗</p> <p>6.34s 10.5x ↘</p> <p>7.42s 10.7x →</p> <p>8.77s 9.1 ←</p> <p>Serie 88 ( 3x)</p> <p>Total 164 ( 4x)</p>
---	---	--	--

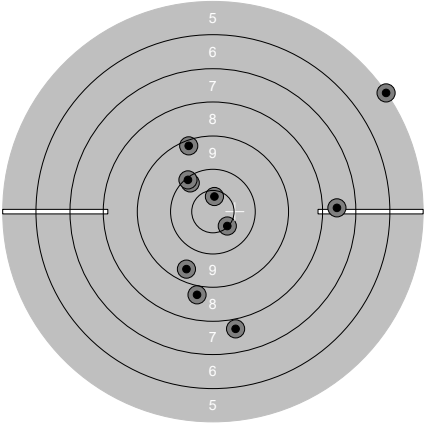
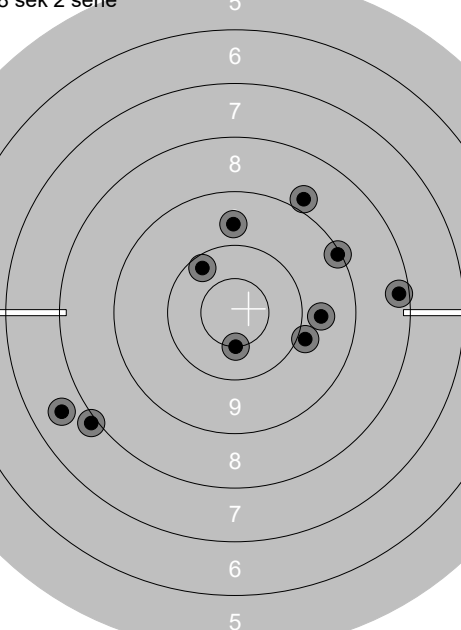
<p>8 sek 1 serie</p> 	<p>2.49s 9.2 ↗</p> <p>4.24s 10.2 ↗</p> <p>5.27s 10.6x ↑</p> <p>6.73s 7.6 →</p> <p>7.94s 5.1 ↗</p> <p>2.89s 9.4 ↓</p> <p>4.00s 7.8 ↓</p> <p>4.98s 8.8 ↓</p> <p>6.11s 10.5x ↘</p> <p>7.48s 10.1 ↗</p> <p>Serie 85 ( 2x)</p> <p>Total 249 ( 6x)</p>	<p>8 sek 2 serie</p> 	<p>2.54s 10.5x ↓</p> <p>4.09s 9.9 →</p> <p>5.48s 8.9 ↗</p> <p>6.51s 8.0 ←</p> <p>7.25s 9.7 →</p> <p>3.23s 9.7 ↑</p> <p>4.28s 7.6 ←</p> <p>5.04s 8.3 →</p> <p>6.11s 10.2 ↗</p> <p>6.98s 9.1 ↗</p> <p>Serie 87 ( 1x)</p> <p>Total 336 ( 7x)</p>
---	--	--	---

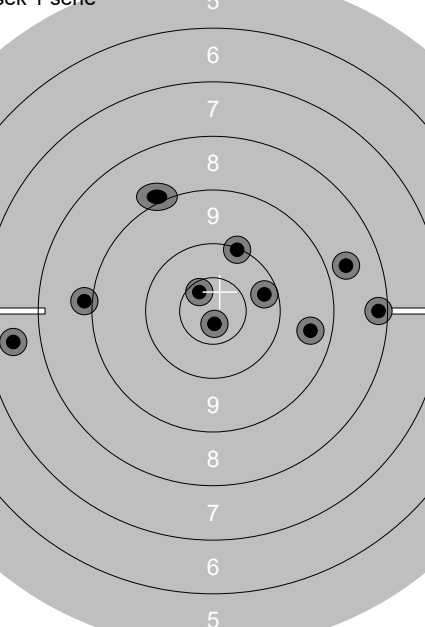
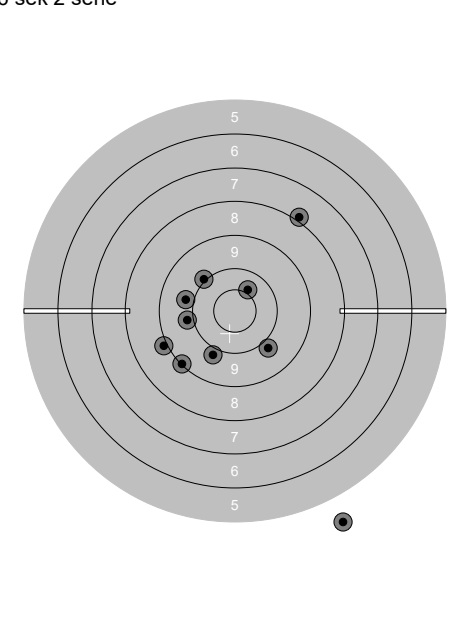
<p>6 sek 1 serie</p> 	<p>2.19s 10.6x ↗</p> <p>3.23s 8.7 →</p> <p>4.05s 10.8x ↓</p> <p>5.00s 9.5 →</p> <p>5.82s 10.2 →</p> <p>2.47s 10.1 ↗</p> <p>3.86s 8.9 ←</p> <p>4.80s 7.6 ←</p> <p>5.72s 8.2 →</p> <p>0.21s ↗</p> <p>Serie 80 ( 2x)</p> <p>Total 416 ( 9x)</p>	<p>6 sek 2 serie</p> 	<p>2.23s 7.9 ↗</p> <p>3.16s 9.8 ←</p> <p>4.38s 0.0 ↓</p> <p>5.29s 9.9 ←</p> <p>6.25s 9.8 ↘</p> <p>2.74s 10.0 ↗</p> <p>3.74s 10.4x ↗</p> <p>4.38s 9.0 ←</p> <p>5.18s 9.9 ↓</p> <p>5.86s 9.1 ←</p> <p>Serie 81 ( 1x)</p> <p>Total 497 ( 10x)</p>
--	--	---	--

Lag	Skive	Bjørn Berven-Hanssen	
1	6	Sola PK	
Hurtigpistol Grov		V55	
25.06.2019		NM bane 2019	
10 sek 1 serie		NM Pistol 2019	
	3.99s 9.5 ↘		2.75s 9.8 ↙
	5.43s 9.1 ↘		3.99s 7.9 ↘
	6.48s 7.5 ↘		5.07s 9.9 ↘
	7.65s 8.0 ↘		6.67s 7.7 ➔
	8.75s 10.0 ↘		8.26s 9.3 ↘
	3.61s 10.2 ↘		2.47s 10.1 ↗
	5.73s 7.9 ↘		3.84s 10.1 ←
	6.64s 9.4 ↘		5.25s 7.4 ↘
	7.51s 6.8 ←		6.45s 9.2 ↘
	8.57s 7.9 ←		7.66s 9.2 ←
Serie 82 ( 0x)	Serie 86 ( 0x)		
Total 82 ( 0x)	Total 168 ( 0x)		
	3.05s 9.1 ↘		2.69s 10.1 ↘
	4.29s 9.0 ↘		3.95s 10.3 ←
	5.39s 8.7 ↘		5.03s 10.4x ↘
	6.58s 9.9 ←		6.48s 9.8 ↘
	7.80s 8.0 ↘		7.59s 10.0 ←
	2.44s 8.8 ➔		3.22s 10.5x ➔
	3.63s 9.6 ↗		4.19s 8.4 ←
	4.65s 10.6x ↗		4.99s 9.8 ←
	5.56s 8.6 ↘		5.90s 10.4x ↘
	6.54s 10.5x ↘		6.80s 9.0 ↘
Serie 88 ( 2x)	Serie 95 ( 3x)		
Total 256 ( 2x)	Total 351 ( 5x)		
	2.04s 9.8 ➔		2.17s 9.3 ↗
	2.92s 10.4x ←		3.15s 10.8x ↘
	3.88s 10.0 ↙		3.96s 10.2 ➔
	4.61s 10.3 ↘		4.91s 9.2 ↘
	5.60s 8.8 ↘		5.72s 9.9 ↘
	2.40s 9.7 ↗		2.43s 8.2 ↗
	3.40s 10.1 ←		3.24s 10.0 ←
	4.22s 10.2 ←		4.09s 8.8 ➔
	5.14s 5.8 ↘		4.80s 9.6 ←
	0.14s ↘		5.79s 10.4x ➔
Serie 81 ( 1x)	Serie 92 ( 2x)		
Total 432 ( 6x)	Total 524 ( 8x)		

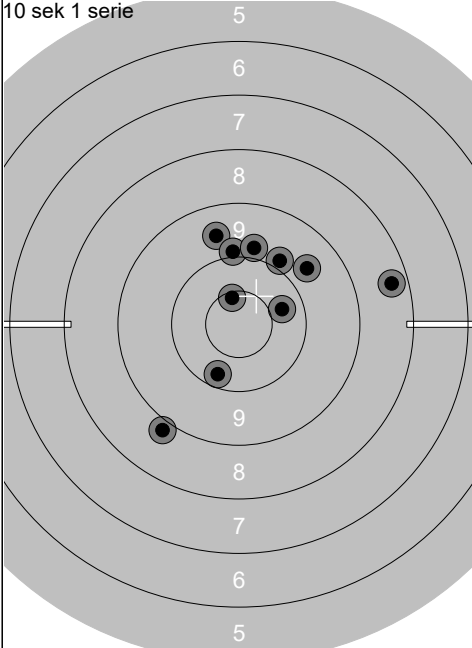
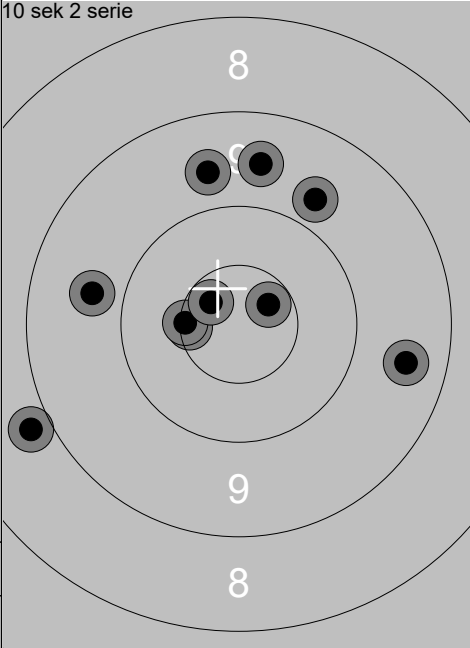
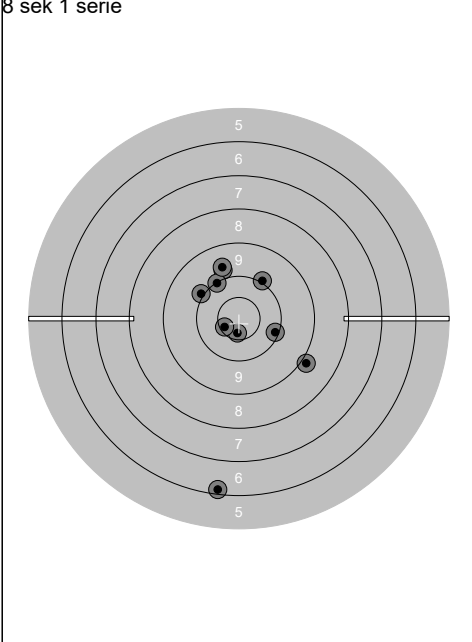
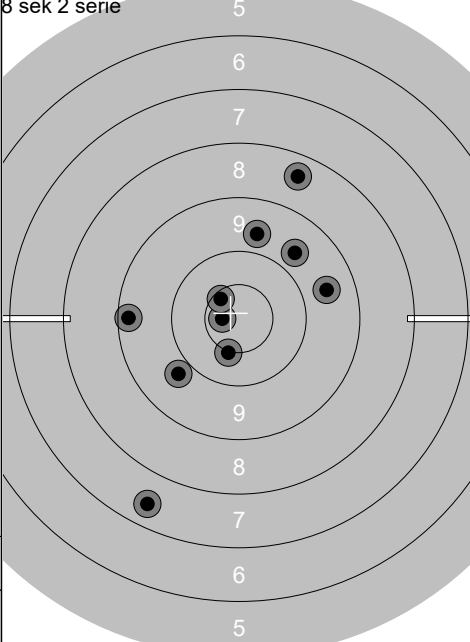
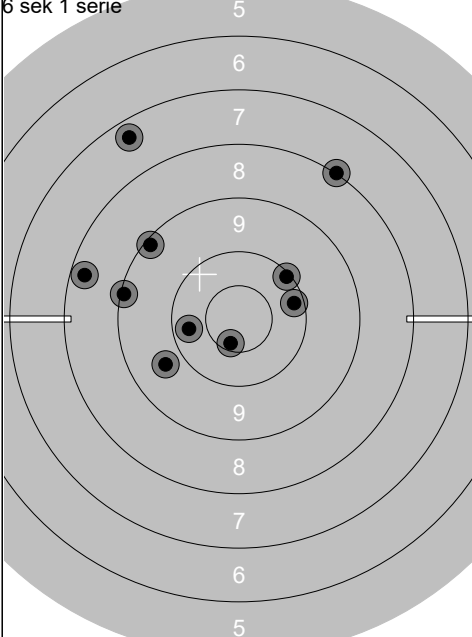
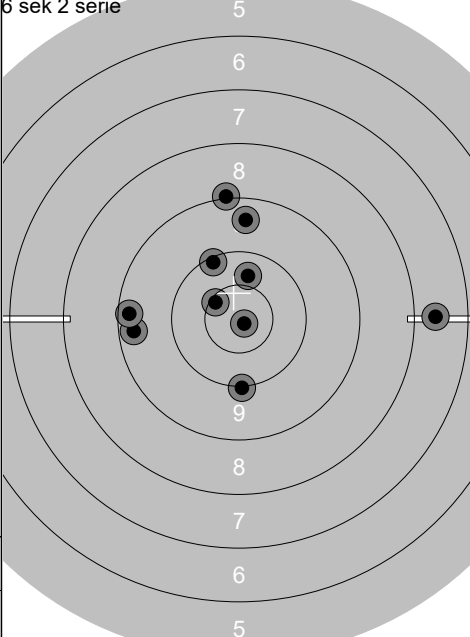
Lag	Skive	Rune Finstad			
1	7	Oslo Komm.Tj.M. Skl		V55	
25.06.2019		NM bane 2019		NM Pistol 2019	
10 sek 1 serie					
		2.72s 10.2 ↘	3.02s 9.6 ↑		
		3.97s 9.6 ↑	4.38s 9.7 ↑		
		5.19s 8.4 →	5.62s 10.6x ←		
		6.80s 9.9 ↗	6.90s 10.5x ←		
		8.11s 8.9 ↘	8.39s 8.9 ←		
		4.48s 10.0 ↑	2.64s 9.5 →		
		5.63s 10.3 →	3.71s 10.7x ↗		
		6.92s 9.9 ↑	5.12s 9.8 ↗		
		8.18s 10.6x ↑	6.19s 10.7x ↖		
		9.35s 9.7 ↗	7.67s 9.7 ←		
		Serie 92 ( 1x)	Serie 93 ( 4x)		
		Total 92 ( 1x)	Total 185 ( 5x)		
8 sek 1 serie					
		2.88s 6.2 ↘	2.00s 9.7 ↗		
		3.91s 10.1 →	3.11s 9.8 ↘		
		5.05s 10.6x ↘	4.34s 9.7 ↑		
		6.10s 9.8 ↑	5.40s 8.5 ↑		
		7.39s 10.0 ↖	6.63s 9.6 →		
		2.62s 8.9 ↘	2.64s 10.7x ←		
		3.65s 10.0 ↗	3.71s 7.5 ↘		
		4.51s 9.7 ↑	4.84s 10.5x ↘		
		5.60s 10.6x ←	6.17s 10.6x ↖		
		6.73s 10.0 ↗	7.57s 9.3 ←		
		Serie 92 ( 2x)	Serie 90 ( 3x)		
		Total 277 ( 7x)	Total 367 ( 10x)		
6 sek 1 serie					
		2.02s 10.2 →	2.13s 10.0 ↘		
		2.93s 10.3 ←	2.93s 10.6x ↖		
		3.73s 9.1 ←	3.85s 10.4 ↑		
		4.62s 7.4 ↗	4.87s 9.4 ←		
		5.65s 8.3 ←	6.08s 10.1 ↗		
		2.14s 8.1 ↗	2.16s 7.7 →		
		3.00s 9.7 ←	3.04s 10.9x ↘		
		3.91s 10.6x ↘	3.84s 9.3 ←		
		4.84s 9.2 ↖	4.67s 9.0 ↑		
		5.90s 10.1 ↗	5.58s 9.5 ↑		
		Serie 90 ( 1x)	Serie 93 ( 2x)		
		Total 457 ( 11x)	Total 550 ( 13x)		

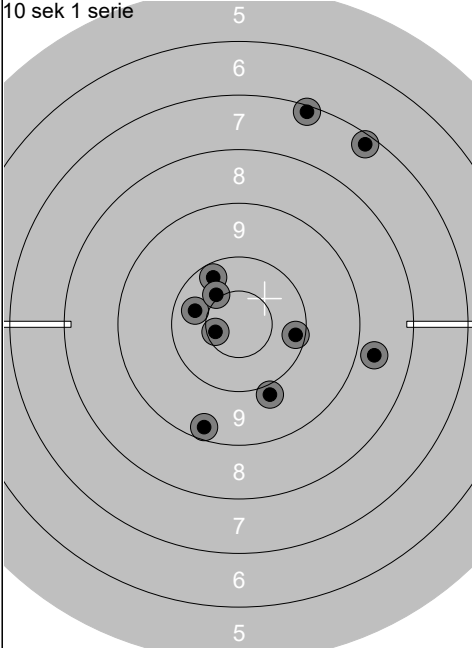
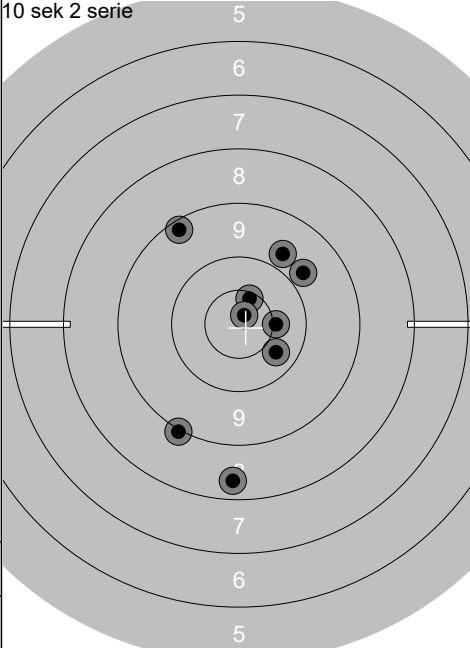
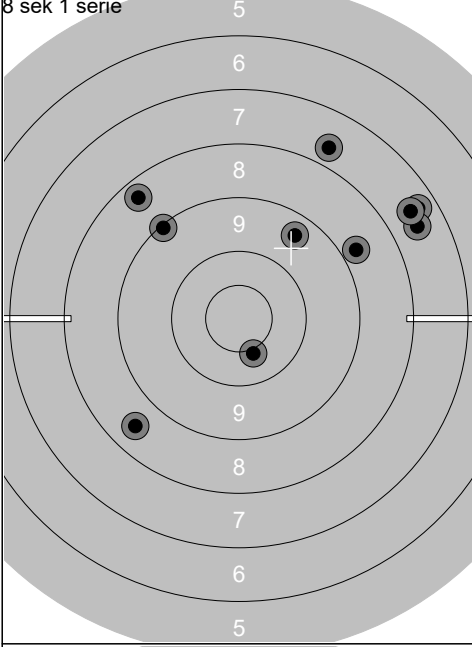
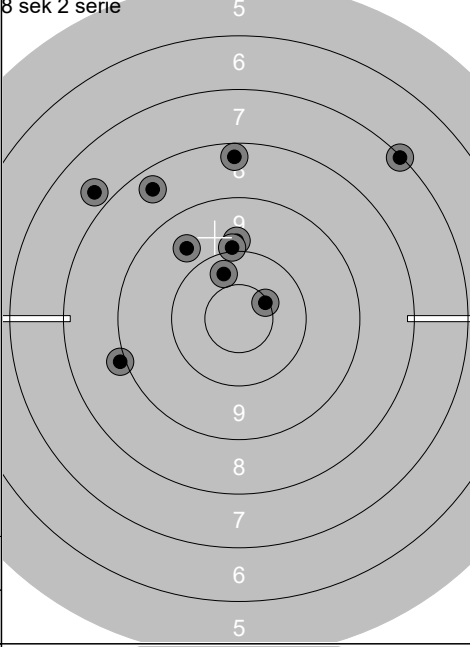
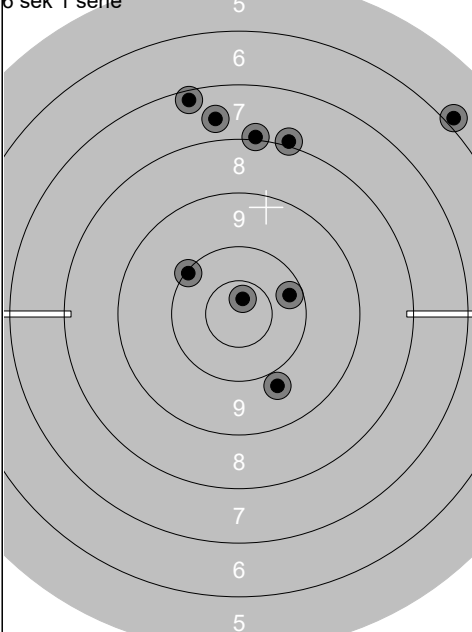
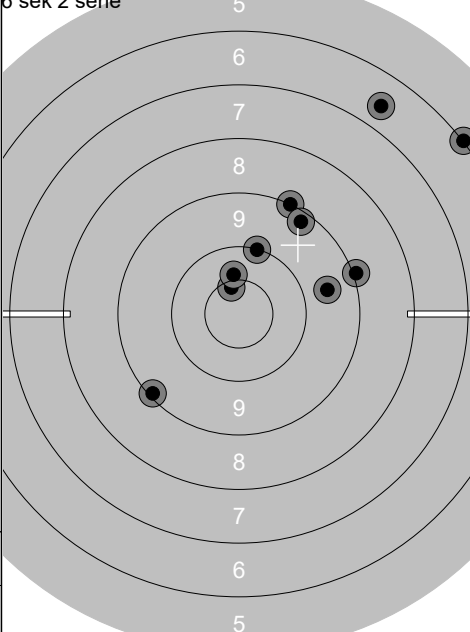
Lag	Skive	Arve Guldhav		
1	8			
Hurtigpistol Grov		Kvinesdal Pk	V55	
25.06.2019		NM bane 2019	NM Pistol 2019	
10 sek 1 serie		3.34s 7.2 ↗		3.10s ↖
		4.28s 10.6x ←		4.49s 10.3 ↘
		5.25s 10.2 →		5.26s 9.0 ↙
		5.87s 9.9 ↓		6.20s 8.4 ↓
		7.00s 10.2 ↗		7.29s 9.8 ↗
		3.37s 7.2 ↗		2.94s 9.3 ↖
		4.33s 10.3 ←		4.34s 9.8 ↗
		5.09s 10.4x ↗		5.09s 10.4x →
		5.96s 9.3 ↓		6.06s 10.6x ↗
		6.97s 8.7 →		8.16s 10.8x ↗
Serie 90 ( 2x)		Serie 84 ( 3x)		
Total 90 ( 2x)		Total 174 ( 5x)		
8 sek 1 serie		2.91s 7.7 ↗		3.71s 7.1 ↗
		3.63s 10.4x ↓		4.65s 9.9 ↑
		5.05s 7.4 ↗		5.46s 10.0 ↑
		6.38s 7.6 ↗		6.33s 7.8 ↖
		7.24s 9.5 ↗		7.41s 10.5x ↗
		4.09s 8.8 ↗		3.42s 8.4 ↖
		5.62s 8.4 ↖		4.28s 8.3 ↑
		6.68s 7.6 ↗		5.80s 9.0 ←
		5.49s 9.1 ↖		6.93s 9.7 ↖
		6.92s 8.5 ↙		7.71s 10.3 ↗
Serie 80 ( 1x)		Serie 87 ( 1x)		
Total 254 ( 6x)		Total 341 ( 7x)		
6 sek 1 serie		3.22s 8.0 ↗		2.68s 10.6x ↗
		4.13s 10.2 →		3.33s 10.0 ↑
		5.03s 10.7x ↗		3.89s 9.1 ↗
		6.09s 9.8 ↓		4.42s 6.6 ↗
		--		5.13s 9.2 ↙
		2.84s 5.9 ↗		2.81s 9.6 →
		3.37s 7.7 ↑		3.60s 9.3 ↗
		4.05s 7.2 ↑		4.19s 6.1 ↗
		4.63s 8.0 ↑		4.84s 10.4x ↑
		5.41s 10.1 ↖		5.68s 9.0 →
Serie 74 ( 1x)		Serie 87 ( 2x)		
Total 415 ( 8x)		Total 502 ( 10x)		

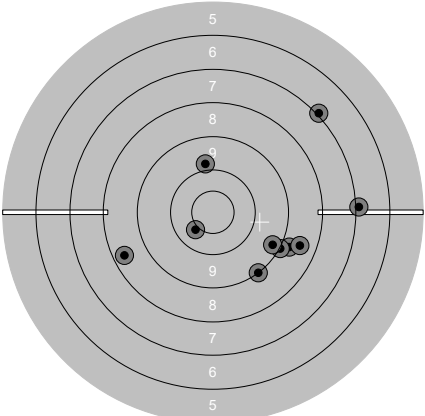
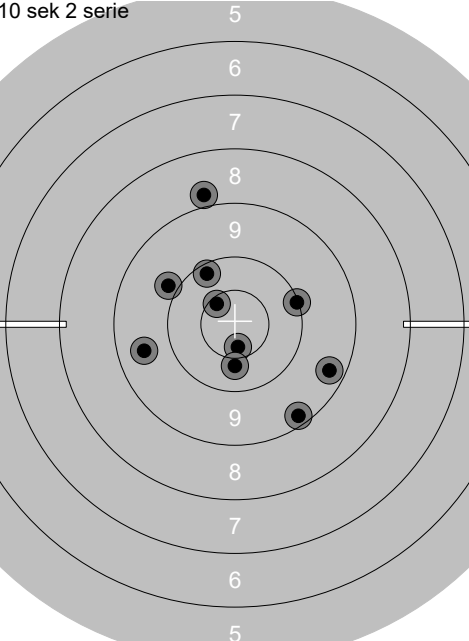
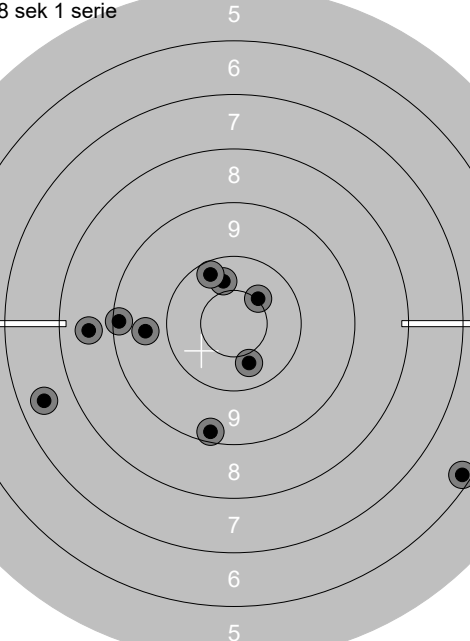
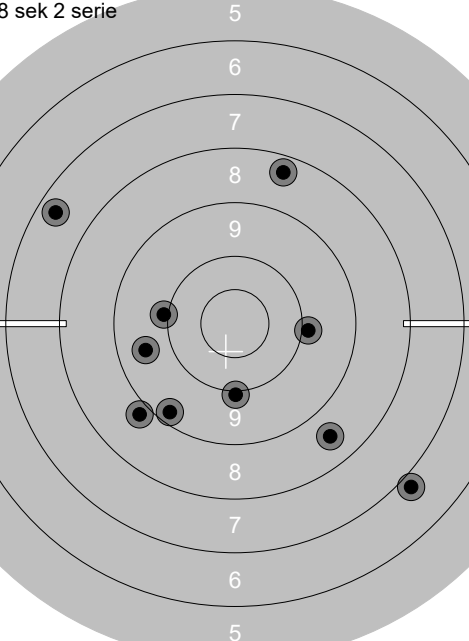
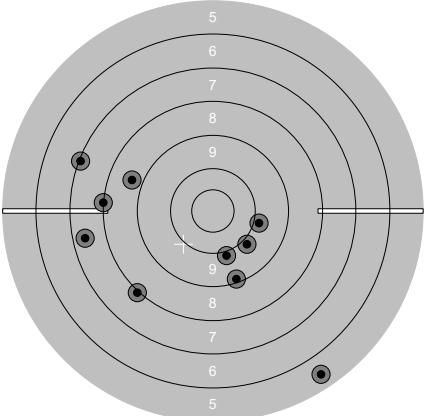
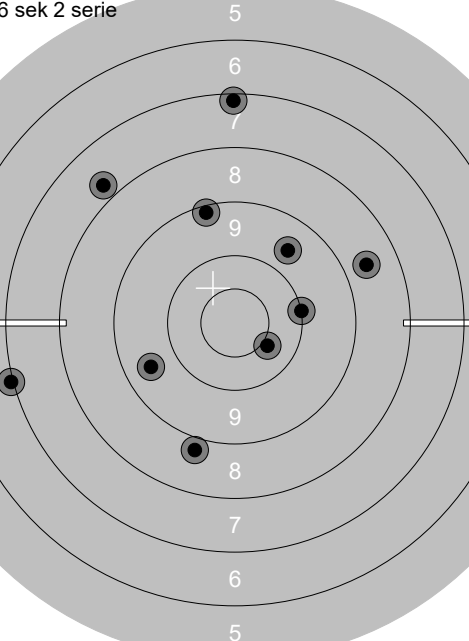
Lag	Skive	Gunnar Orthe		
1	9	Haugesund Pk	V55	
25.06.2019	NM bane 2019	NM Pistol 2019		
10 sek 1 serie		3.08s 8.8 ↘ 4.16s 9.0 ↘ 5.37s 9.3 ↘ 6.59s 7.0 → 7.81s 7.0 ↗ 3.02s 9.1 ↘ 4.13s 9.9 ↑ 5.21s 8.5 ↘ 6.14s 10.4x ↙ 7.37s 8.4 ←	10 sek 2 serie 	2.77s 8.9 ↑ 4.00s 10.2 ↖ 5.04s 10.6x ↓ 6.06s 10.6x ↖ 7.06s 9.6 ← 2.79s 10.4 ↓ 3.96s 10.1 → 5.05s 9.2 ↘ 5.99s 9.4 ↘ 6.96s 9.9 ↖
	Serie 84 ( 1x)		Serie 94 ( 2x)	
	Total 84 ( 1x)		Total 178 ( 3x)	
8 sek 1 serie		2.52s 9.2 ← 3.55s 10.4 ↑ 5.52s 6.2 ↘ 6.63s 10.2 ↗ 7.65s 7.5 ← 2.48s 9.7 ← 3.49s 10.4 ↓ 4.51s 9.3 ↓ 5.53s 10.5x ↗ 6.57s 8.6 ←	8 sek 2 serie 	2.50s 7.4 ↖ 3.79s 9.3 ↘ 4.62s 6.9 ↘ 5.47s 9.9 → 6.20s 8.6 ↘ 2.42s 8.4 ↑ 3.57s 9.6 ← 4.61s 10.0 ↓ 5.57s 10.0 ← 6.41s 8.9 ↙
	Serie 88 ( 1x)		Serie 84 ( 0x)	
	Total 266 ( 4x)		Total 350 ( 4x)	
6 sek 1 serie		2.17s 9.9 ↘ 2.99s 9.2 ↘ 3.73s 7.1 ← 4.55s 7.4 ← 5.23s 8.1 ← 2.14s 9.9 ↘ 3.05s 9.9 → 3.89s 8.7 ↖ 4.69s 8.0 ↘ 5.47s 5.5 ↘	6 sek 2 serie 	2.34s 8.8 ↓ 3.27s 10.0 → 4.00s 10.4x ↘ 4.69s 9.6 ← 5.46s 7.0 ← 2.06s 7.2 ↑ 3.08s 7.8 ↖ 3.93s 9.7 ↗ 4.59s 8.7 → 5.32s 9.2 ↑
	Serie 79 ( 0x)		Serie 84 ( 1x)	
	Total 429 ( 4x)		Total 513 ( 5x)	

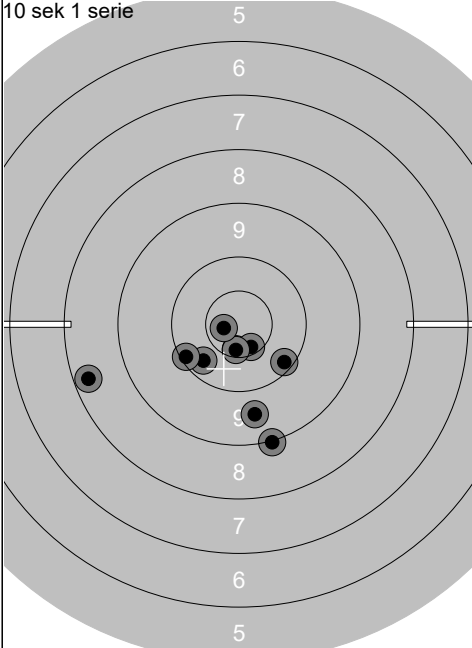
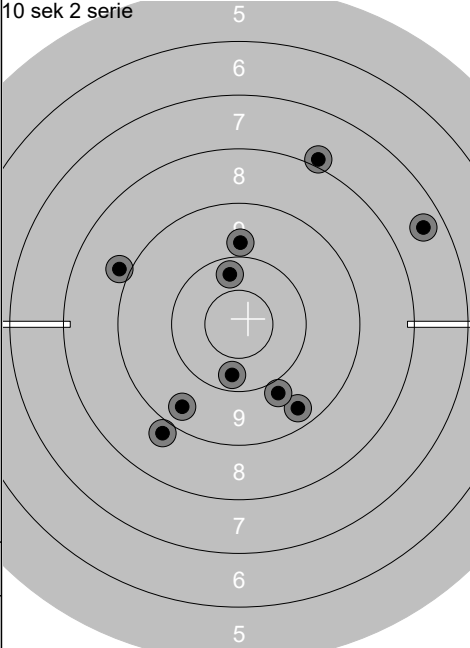
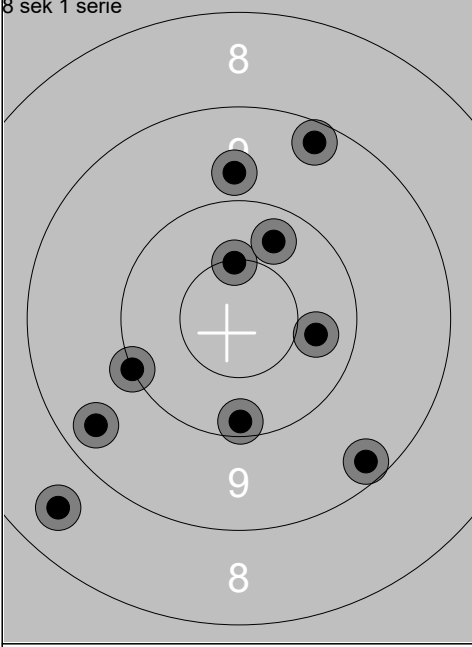
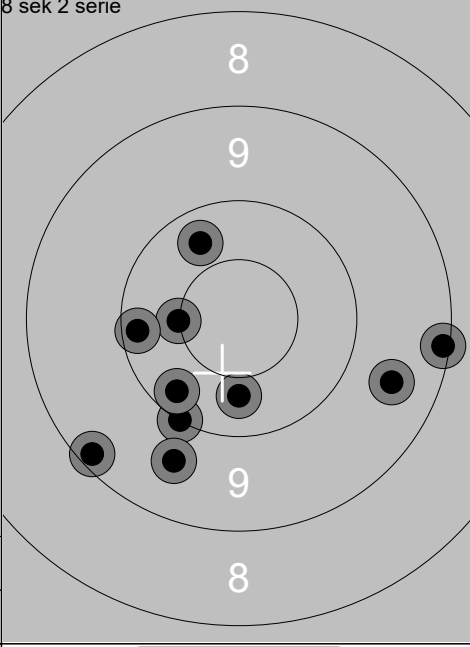
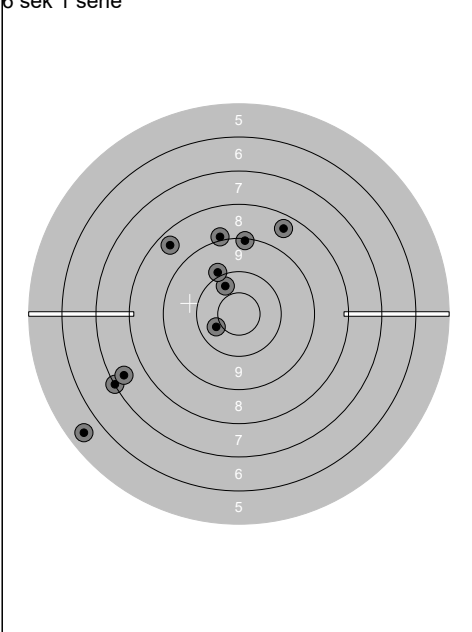
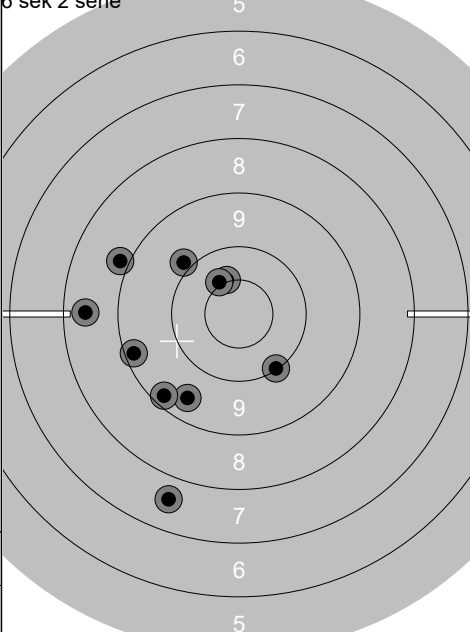

Lag	Skive	Harald Andre Knoop	
1	10	Hurtigpistol Grov	Sola PK V55
25.06.2019	NM bane 2019	NM Pistol 2019	
10 sek 1 serie		3.64s 10.6x ↘ 5.31s 10.3 ↙ 6.76s 8.3 ← 7.93s 9.6 ↘ 9.08s 9.0 ↘ 2.97s 10.6x ↘ 4.99s 10.1 ↘ 6.16s 10.6x ↘ 7.32s 10.1 ↙ 8.50s 10.7x ←	
	Serie 96 ( 4x) Total 96 ( 4x)	2.88s 9.4 ↘ 4.51s 9.5 ↘ 5.70s 10.3 ↑ 6.93s 7.9 ↗ 8.03s 8.8 ↘ 3.07s 10.3 ↘ 4.43s 9.8 ↑ 6.01s 7.5 → 7.32s 8.9 ← 8.42s 9.9 ↘	Serie 86 ( 0x) Total 182 ( 4x)
8 sek 1 serie		2.25s 9.3 ↘ 3.50s 9.8 ↑ 5.11s 10.5x ↑ 6.30s 10.1 ↘ 7.72s 10.3 ↗ 3.36s 9.3 ↗ 4.73s 10.0 ← 5.72s 8.5 ↘ 6.70s 10.3 → 7.58s 9.4 ↙	
	Serie 94 ( 1x) Total 276 ( 5x)	2.24s 10.3 ↗ 3.39s 10.5x ← 4.51s 10.2 ← 5.45s 10.0 ↘ 6.62s 10.4 ↘ 2.63s 9.1 → 3.67s 9.2 ↘ 4.78s 10.2 ↘ 5.83s 9.6 → 6.92s 9.7 ↘	Serie 96 ( 1x) Total 372 ( 6x)
6 sek 1 serie		2.06s 10.3 ↗ 3.20s 7.1 ← 3.99s 8.4 ↗ 4.72s 5.5 ← 5.37s 8.5 ↗ 2.18s 10.4 ← 3.20s 7.5 ← 4.01s 9.9 ↗ 4.80s 9.1 ↑ 5.61s 9.0 ↑	
	Serie 82 ( 0x) Total 454 ( 6x)	2.06s 10.1 ↘ 2.96s 9.5 ↘ 3.86s 9.9 ↗ 4.76s 7.6 ↘ 5.66s 8.9 ← 2.14s 9.3 ↘ 2.99s 10.5x ↑ 3.79s 10.4x ↗ 4.67s 8.5 ← 5.51s 9.2 ←	Serie 89 ( 2x) Total 543 ( 8x)

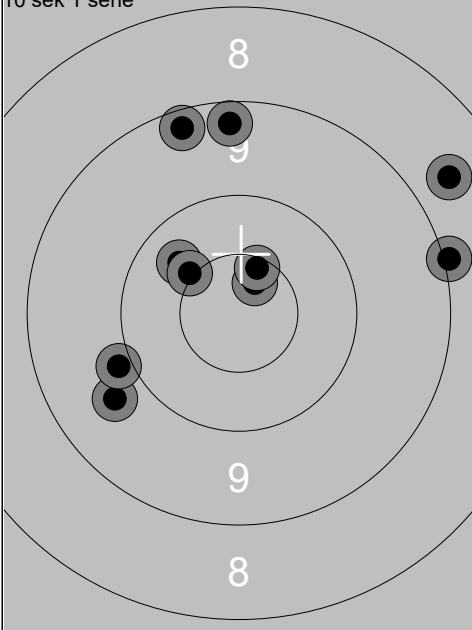
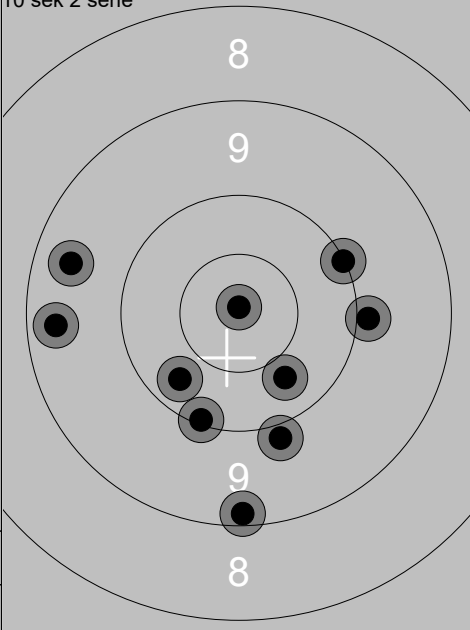
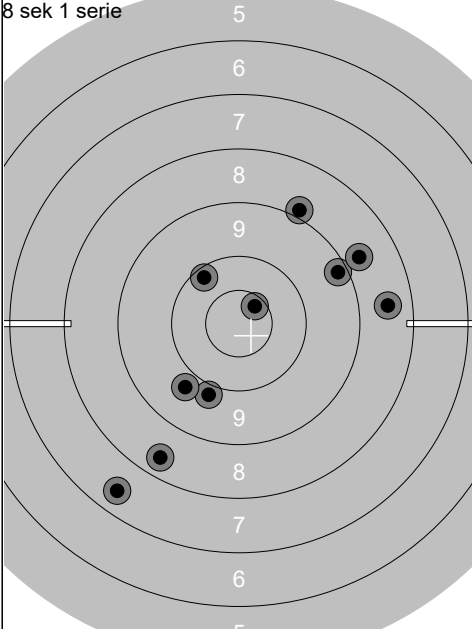
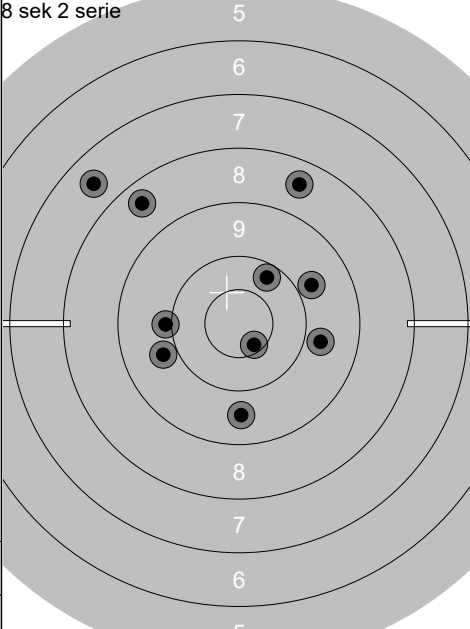
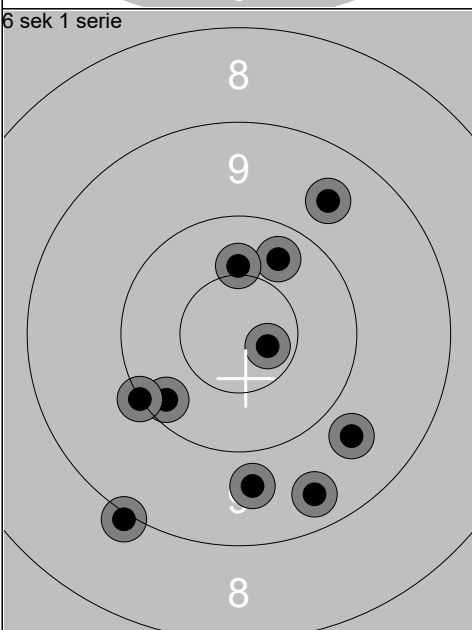
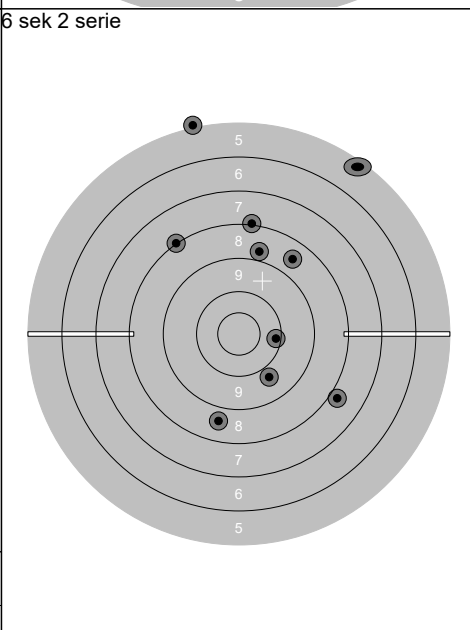
Lag	Skive	Rune Hammer	
1	11		
Hurtigpistol Grov		Aron Skytterklubb Drammen	
25.06.2019		NM bane 2019	NM Pistol 2019
10 sek 1 serie			
3.71s 9.0 → 5.05s 10.3 ↖ 6.28s 10.7x ↗ 7.35s 9.3 ↑ 8.49s 8.7 ↗ 3.08s 10.5x ↖ 4.17s 9.7 ↙ 5.18s 10.6x ↗ 6.44s 9.3 ↑ 7.63s 9.9 ← Serie 93 ( 3x) Total 93 ( 3x)		3.12s 10.3 ↘ 4.40s 9.9 ↘ 5.65s 9.2 ↓ 6.68s 9.9 → 7.88s 10.0 ↗ 2.75s 10.3 ↙ 3.77s 10.9x ↑ 4.74s 9.4 ← 5.74s 9.5 ← 7.07s 10.1 ↓ Serie 95 ( 1x) Total 188 ( 4x)	
8 sek 1 serie			
2.84s 8.9 ↗ 4.29s 10.2 ↖ 5.01s 9.2 ↗ 6.08s 9.9 ↓ 7.33s 10.6x ↗ 2.86s 8.5 → 4.57s 7.5 ↓ 6.05s 9.8 ↙ 6.66s 8.8 ↗ 7.44s 8.4 ↓ Serie 86 ( 1x) Total 274 ( 5x)		2.72s 7.6 ↖ 3.78s 10.0 ← 4.70s 9.8 → 5.63s 10.2 ↗ 6.52s 9.8 ↗ 3.12s 9.8 ← 4.25s 10.6x ↘ 5.52s 8.5 ↗ 7.03s 8.5 ↖ 7.77s 9.6 ↓ Serie 89 ( 1x) Total 363 ( 6x)	
6 sek 1 serie			
2.31s 10.2 ↙ 3.16s 10.0 ↙ 3.97s 9.7 ↓ 4.74s 9.4 ↓ 5.40s 9.6 ↗ 2.22s 10.3 ↗ 3.23s 10.7x → 3.91s 9.0 ↙ 4.51s 10.4x ↑ 5.27s 9.7 ↘ Serie 95 ( 2x) Total 458 ( 8x)		2.41s 10.1 → 3.54s 7.8 ↘ 4.33s 9.8 ↘ 5.24s 8.7 ↓ 0.07s ↗ 2.16s 8.8 ↑ 3.02s 8.6 ↗ 3.79s 8.0 ↑ 4.58s 5.0 ↑ 5.59s 8.0 ↖ Serie 71 ( 0x) Total 529 ( 8x)	

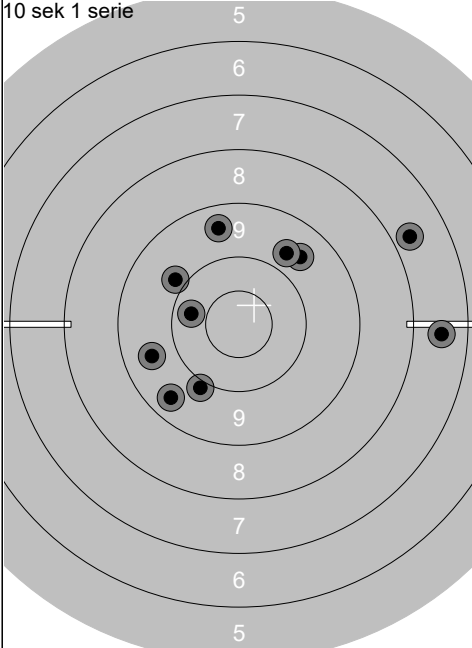
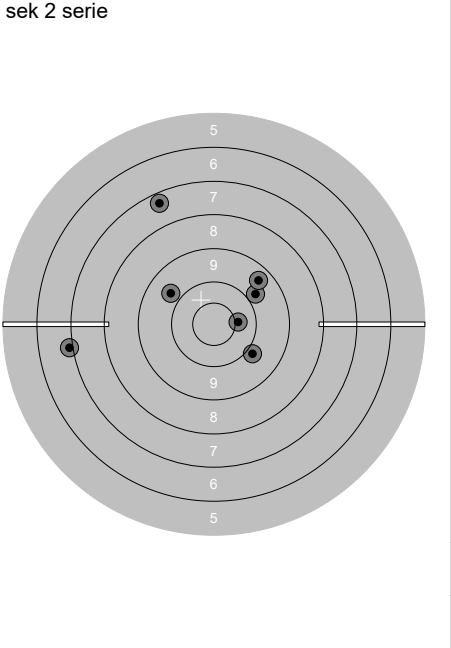
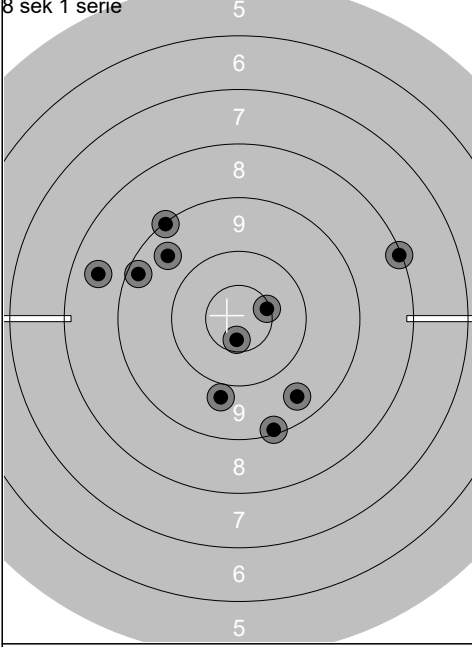
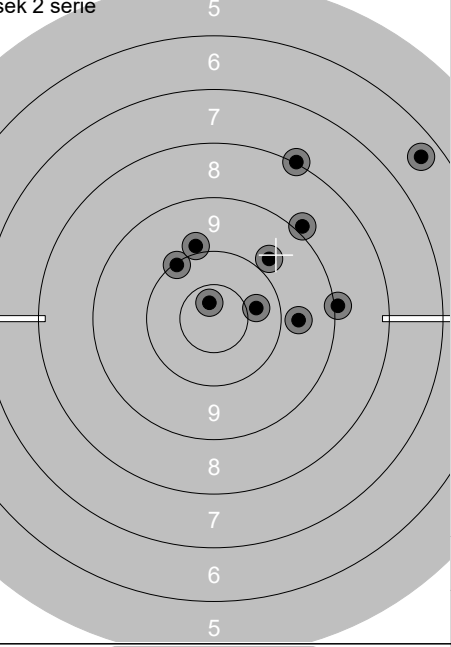
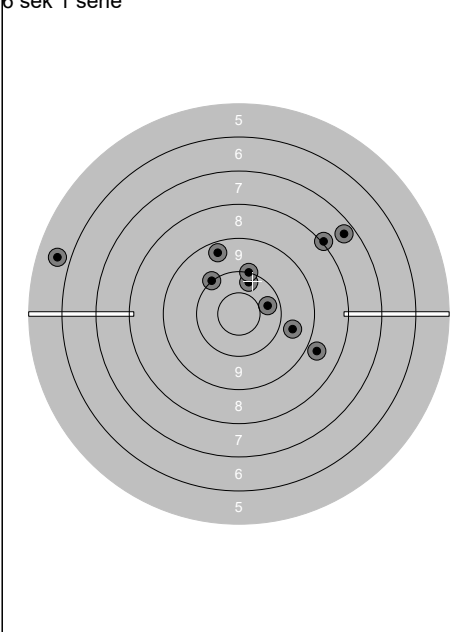
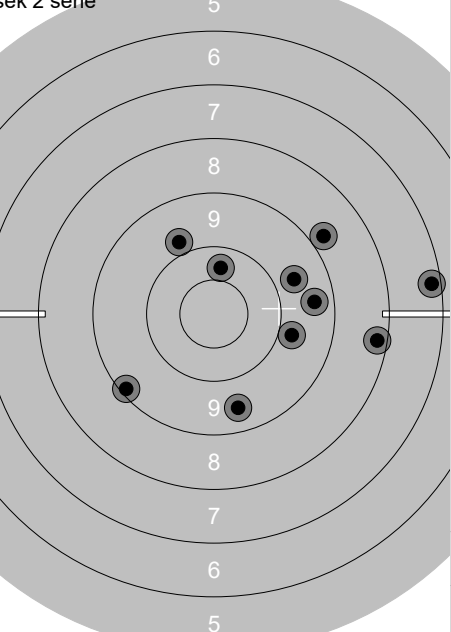
Lag	Skive	Helge Olden	
1	12	Ørland Pk	V55
25.06.2019		NM bane 2019	
25.06.2019		NM Pistol 2019	
10 sek 1 serie		2.84s 9.6 ← 4.19s 9.9 ↘ 5.53s 9.5 ↑ 6.80s 9.5 ↘ 8.03s 10.3 ← 2.95s 9.9 ↘ 4.30s 7.8 → 5.46s 9.6 ↗ 6.66s 7.6 → 8.16s 9.7 ↗ Serie 87 ( 0x) Total 87 ( 0x)	10 sek 2 serie  8.08s ☒ 8.88s ☒ 9.50s 7.4 ↗ 10.2s 7.0 ← -- 2.74s 9.8 ↘ 4.05s 9.8 → 5.31s 9.5 ↗ 6.50s 10.4x → 7.81s 9.9 ↘ Serie 60 ( 1x) Total 147 ( 1x)
8 sek 1 serie		2.23s 9.6 ↘ 2.96s 9.1 ↗ 4.46s 8.6 ← 5.31s 10.5x → 6.34s 9.3 ← 2.49s 9.2 ↘ 4.04s 8.1 → 5.42s 10.7x ↘ 6.41s 9.5 ↘ 7.36s 9.8 ↘ Serie 90 ( 2x) Total 237 ( 3x)	8 sek 2 serie  2.78s 9.7 → 3.94s 9.0 → 4.98s 10.1 ↗ 5.87s 10.4 → 6.88s 10.7x ↗ 2.24s 8.0 ↗ 3.95s 9.9 ↗ 4.74s 6.4 ↗ 5.62s 9.8 ↗ 6.59s 8.9 ↗ Serie 88 ( 1x) Total 325 ( 4x)
6 sek 1 serie		2.06s 5.7 ← 2.92s 9.7 → 3.74s 9.4 ↗ 4.82s 10.2 ↗ 5.79s 10.0 ↗ 2.37s 10.0 ↗ 3.23s 10.3 → 4.04s 8.8 → 4.94s 7.4 ↗ 5.66s 8.0 ↗ Serie 86 ( 0x) Total 411 ( 4x)	6 sek 2 serie  2.10s 9.5 ↘ 3.20s 9.2 ↘ 4.22s 7.2 → 5.09s 9.7 → 6.07s 9.8 → 2.00s 9.8 ↗ 2.90s 8.8 ↗ 3.80s 9.4 → 4.61s 8.3 → 5.85s 10.3 ↗ Serie 87 ( 0x) Total 498 ( 4x)

Lag	Skive	Odd Harald Pedersen	
1	13		
Hurtigpistol Grov		Haugesund Pk	
25.06.2019		NM bane 2019	
		NM Pistol 2019	
10 sek 1 serie		3.15s 9.7 ↘ 4.62s 9.8 → 5.69s 10.1 ↘ 6.78s 9.4 → 7.96s 10.2 ← 2.97s 10.5x ↓ 4.09s 10.4x ↓ 5.52s 10.6x ↓ 6.73s 8.3 → 7.99s 7.9 ↙ <b>Serie 92 ( 3x)</b> <b>Total 92 ( 3x)</b>	10 sek 2 serie  3.13s 10.4 ↘ 4.55s 10.5x ↓ 5.84s 8.0 → 7.30s 9.3 ↓ 8.56s 9.3 ↓ 3.49s 7.3 → 4.57s 9.7 ↘ 5.55s 8.5 ↘ 6.69s 10.3 ↙ 8.02s 10.2 ↓ <b>Serie 90 ( 1x)</b> <b>Total 182 ( 4x)</b>
8 sek 1 serie		2.24s 8.2 → 3.48s 10.1 ← 4.66s 9.1 ↘ 5.91s 7.9 ↓ 7.38s 9.7 ↗ 2.13s 9.7 ↑ 3.62s 9.0 ↓ 4.84s 10.1 ↙ 6.16s 10.1 ↗ 7.40s 10.2 ↙ <b>Serie 91 ( 0x)</b> <b>Total 273 ( 4x)</b>	8 sek 2 serie  3.05s 8.4 ↙ 4.36s 9.1 ↙ 5.42s 10.1 ↗ 6.44s 9.2 → 7.40s 7.8 → 2.75s 10.6x ↙ 3.74s 9.9 ↓ 5.05s 9.4 → 6.26s 9.1 ↙ 7.39s 8.3 ↓ <b>Serie 88 ( 1x)</b> <b>Total 361 ( 5x)</b>
6 sek 1 serie		2.10s 10.5x ↗ 2.92s 8.9 ↓ 3.74s 9.8 → 4.68s 9.9 ← 5.80s 8.0 ↗ 2.25s 8.8 → 3.00s 6.6 ↓ 4.15s ☐ 4.92s 9.7 → 5.73s 8.3 ↗ <b>Serie 75 ( 1x)</b> <b>Total 436 ( 6x)</b>	6 sek 2 serie  2.58s ☐ 3.44s 9.1 ↘ 4.47s 7.1 → 5.31s 9.6 ↙ 6.18s 8.7 → 2.37s 10.1 → 3.62s 8.1 ↗ 4.70s 5.7 → 5.62s 7.0 ↗ 0.13s ↗ <b>Serie 63 ( 0x)</b> <b>Total 499 ( 6x)</b>

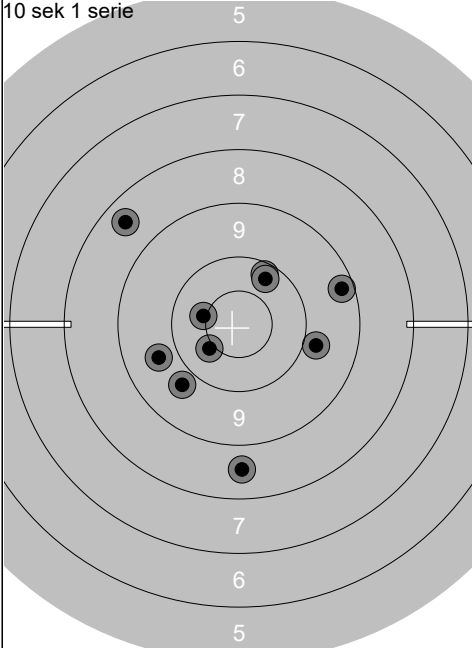
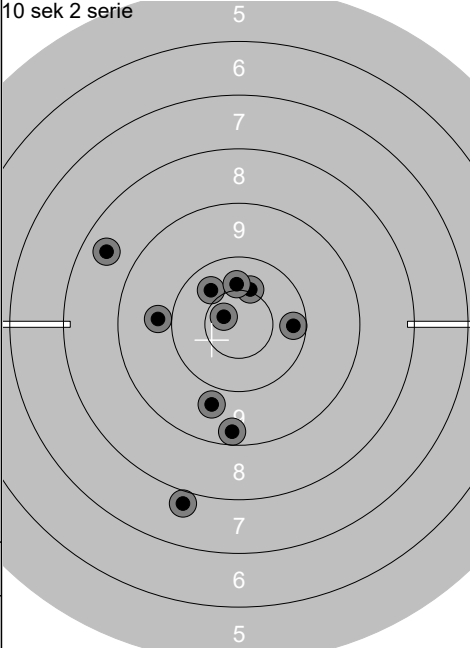
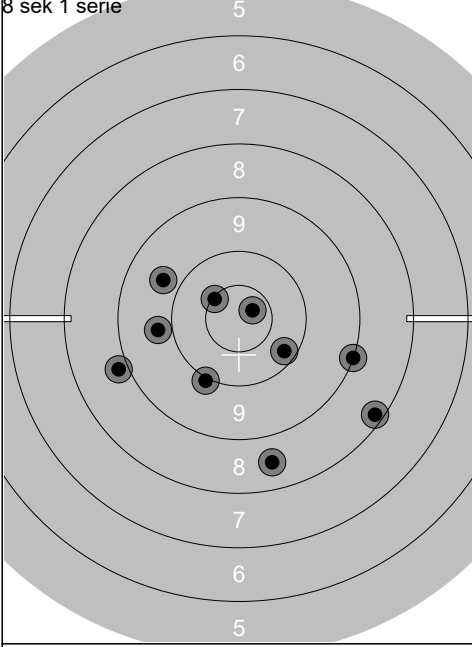
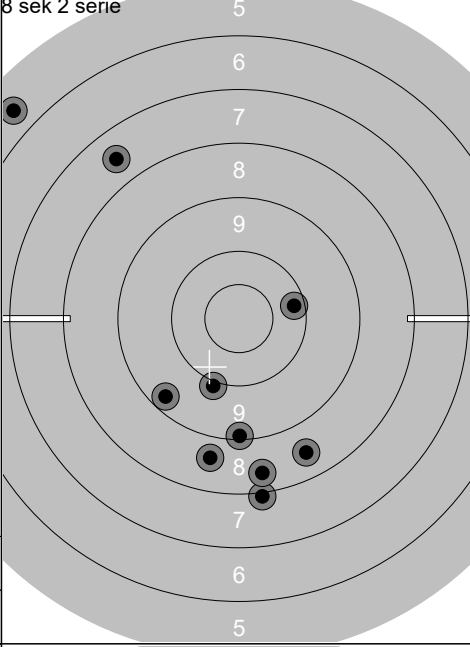
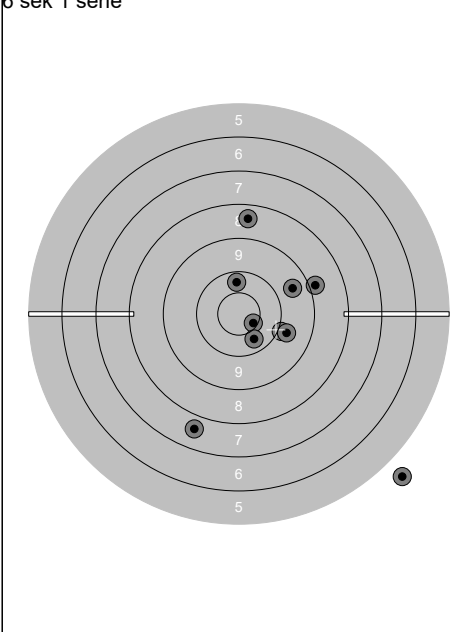
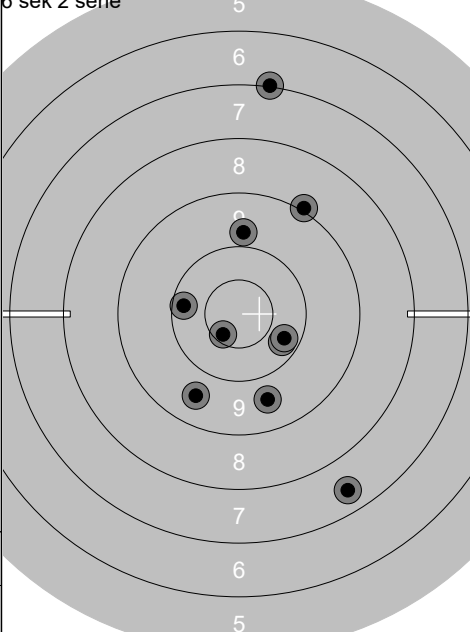
Lag	Skive	Målfrid Pernille Vannebo	
1	14		
Hurtigpistol Grov		Numedal SSK	V55
25.06.2019		NM bane 2019	NM Pistol 2019
10 sek 1 serie		2.61s 9.8 → 4.01s 9.8 ↙ 5.43s 10.2 ↗ 6.95s 9.7 ↙ 8.46s 8.5 ↙ 2.38s 10.4x ↙ 3.85s 8.6 ↓ 5.16s 9.3 → 6.41s 10.5x ↙ 8.14s 10.2 ↗ Serie 92 ( 2x) Total 92 ( 2x)	10 sek 2 serie  2.27s 8.5 ↙ 3.51s 10.2 → 4.78s 10.5x ↗ 6.19s 9.7 ↓ 7.63s 10.7x ↙ 2.29s 10.4 ↗ 3.68s 9.8 ← 4.88s 7.8 ↓ 6.00s 10.4 ↑ 7.27s 9.3 ↓ Serie 92 ( 2x) Total 184 ( 4x)
8 sek 1 serie		2.06s 9.8 ↙ 3.20s 9.8 ← 4.30s 10.7x → 5.34s 10.0 ↓ 6.60s 8.9 ↙ 2.17s 9.1 → 3.39s 10.5x ↗ 4.62s 8.2 ↘ 5.80s 8.6 ↓ 7.05s 10.2 ↘ Serie 91 ( 2x) Total 275 ( 6x)	8 sek 2 serie  2.34s 5.6 ↙ 3.66s 8.5 ↓ 4.73s 8.0 ↓ 5.67s 9.3 ↙ 6.78s 8.7 ↓ 2.12s 10.2 → 3.10s 7.6 ↗ 4.07s 9.1 ↓ 5.03s 8.4 ↓ 6.21s 10.0 ↓ Serie 82 ( 0x) Total 357 ( 6x)
6 sek 1 serie		1.90s 10.6x ↘ 2.79s 10.0 → 3.68s 7.7 ↓ 4.49s 10.3 ↓ 5.35s 0.0 ↓ 1.59s 8.9 → 2.68s 9.8 → 3.58s 10.3 ↑ 4.28s 8.5 ↑ 5.07s 9.6 → Serie 81 ( 1x) Total 438 ( 7x)	6 sek 2 serie  1.92s 10.2 ← 2.82s 9.6 ↓ 3.63s 9.7 ↓ 4.38s 7.5 ↓ 5.18s 10.3 → 1.85s 9.0 ↗ 3.04s 7.0 ↑ 3.85s 10.3 → 4.68s 9.8 ↑ 5.49s 10.6x ↙ Serie 90 ( 1x) Total 528 ( 8x)

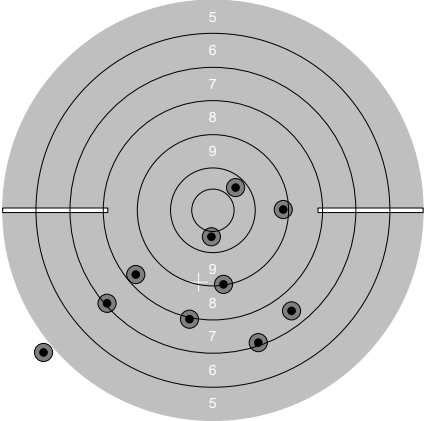
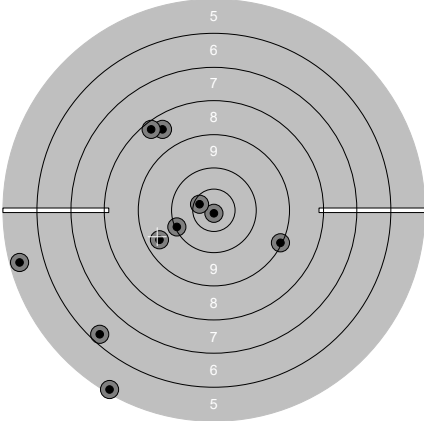
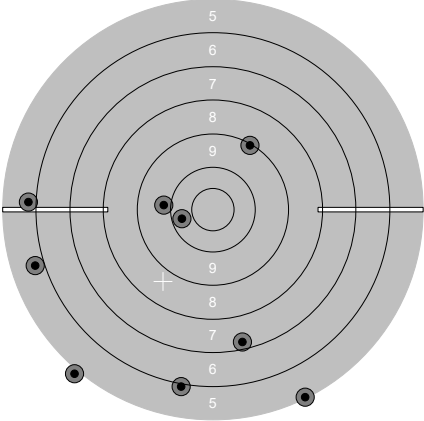
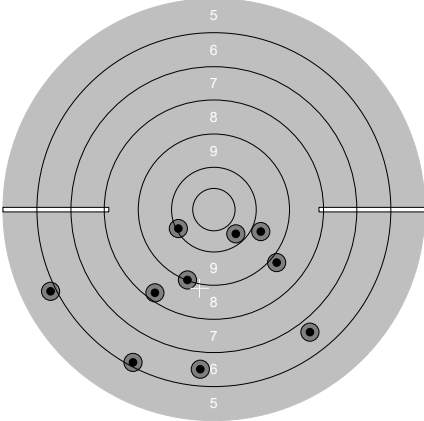
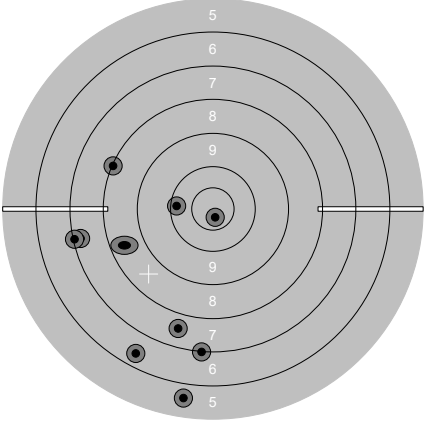
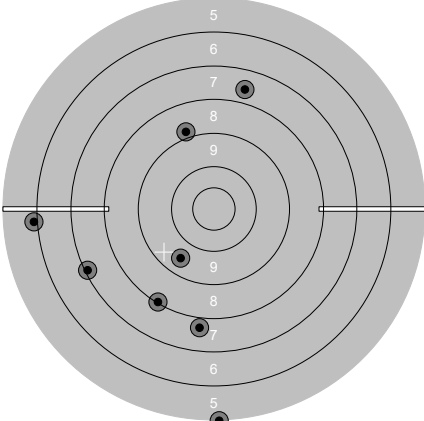
Lag	Skive	Finn Eric Tjørve		
1	15			
Hurtigpistol Grov		Kvinesdal Pk	V55	
25.06.2019		NM bane 2019	NM Pistol 2019	
10 sek 1 serie		2.29s 10.4 ↓ 3.65s 8.3 ↙ 5.01s 0.0 ↙ 6.35s 9.2 → 8.14s 9.1 ↓ 2.36s 7.5 ↘ 3.85s 8.0 ↓ 5.16s 7.1 ↙ 6.57s 10.3 ↗ 7.89s 7.2 ↓ Serie 75 ( 0x) Total 75 ( 0x)	10 sek 2 serie 	2.16s 10.9x ↓ 3.43s 8.5 ↗ 4.61s 5.3 ← 5.86s 5.2 ↓ 7.07s 8.3 ↗ 2.36s 10.6x ↙ 3.52s 9.1 → 4.76s 6.3 ↙ 5.82s 10.1 ← 7.12s 9.5 ← Serie 80 ( 2x) Total 155 ( 2x)
8 sek 1 serie		2.43s 7.3 ↓ 3.55s 5.8 ← 4.50s 9.9 ← 5.53s 10.2 ← 6.80s 0.0 ↓ 2.43s 6.0 ↓ 3.38s 5.1 ↓ 4.43s 9.1 ↗ 5.58s ☐ 6.63s 5.8 ← Serie 56 ( 0x) Total 211 ( 2x)	8 sek 2 serie 	2.67s 8.9 ↘ 3.60s 10.1 ↙ 4.62s 10.2 ↘ 5.75s 6.2 ↓ 6.84s 8.3 ↓ 2.37s 6.6 ↓ 3.32s 6.7 ↘ 4.41s 9.1 ↓ 5.53s 9.8 ↘ 6.69s 5.9 ↙ Serie 77 ( 0x) Total 288 ( 2x)
6 sek 1 serie		2.18s 10.8x ↓ 3.16s 5.6 ↓ 4.18s 7.6 ↓ 5.20s 7.1 ↓ 0.00s ↗ 2.86s 6.4 ↓ 3.64s 10.2 ← 4.54s 7.3 ← 5.34s 7.1 ← 6.13s 8.1 ↙ Serie 67 ( 1x) Total 355 ( 3x)	6 sek 2 serie 	2.08s 7.6 ↗ 2.92s 5.0 ↓ 1.95s 7.8 ↓ 2.97s ☐ 5.57s 8.1 ↓ 1.95s 9.6 ↓ 2.85s 8.9 ↗ 3.78s 6.0 ← 4.72s 7.2 ↙ 5.70s ☐ Serie 57 ( 0x) Total 412 ( 3x)

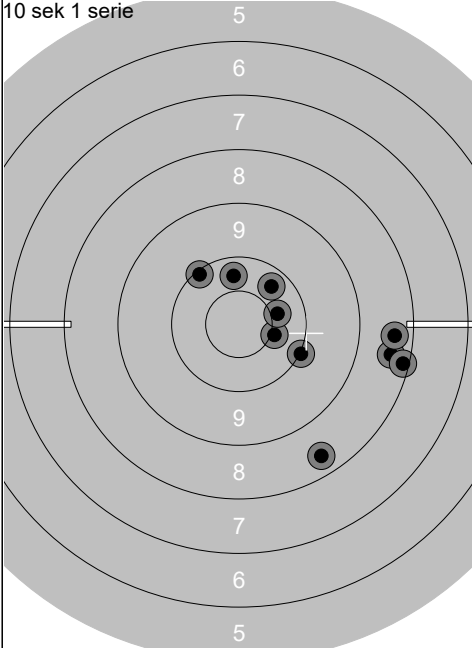
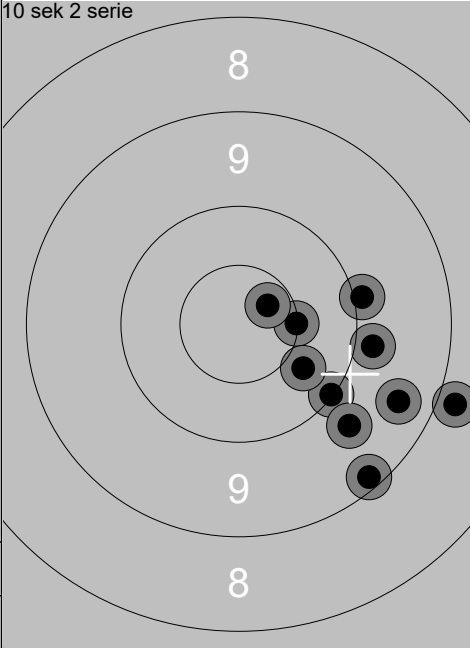
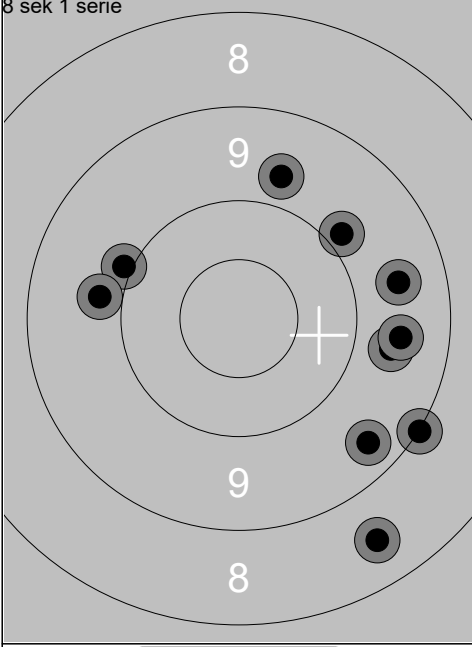
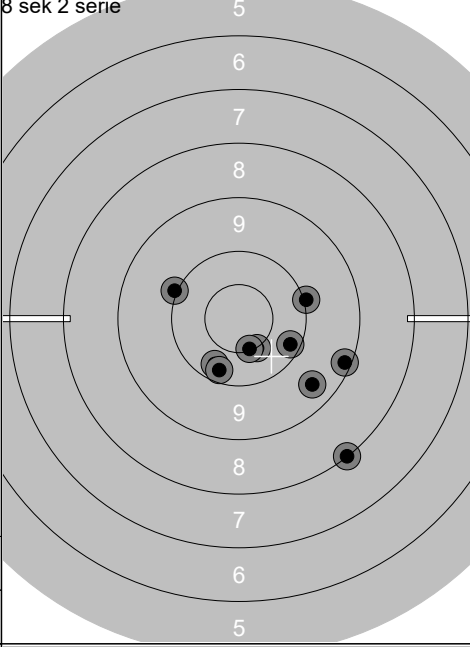
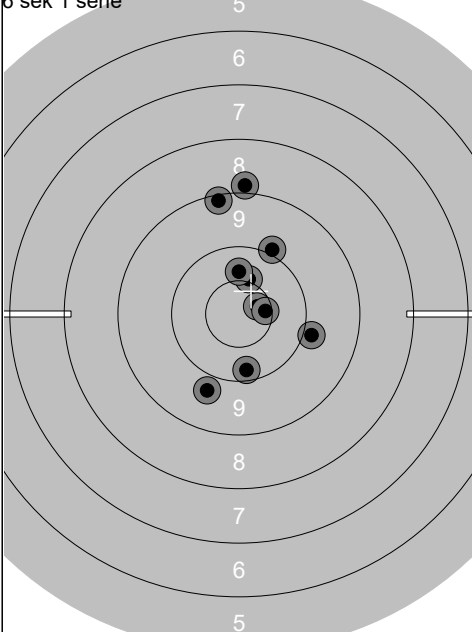
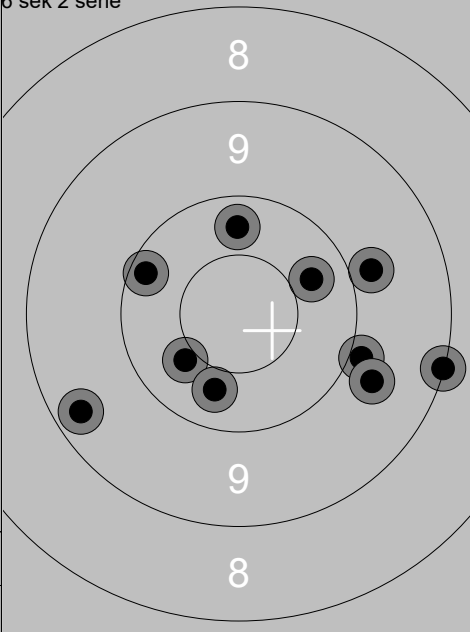
Lag	Skive	Mattis Czternasty Hembre		Jr
1	17			
Hurtigpistol Grov		Bærum PK		
25.06.2019		NM bane 2019		NM Pistol 2019
10 sek 1 serie		3.03s 8.4 → 4.71s 10.4x → 6.51s 10.0 → 7.77s 10.4x → 10.2s 8.4 ↓ 2.73s 8.2 → 4.47s 8.4 → 6.08s 10.3 ↑ 7.28s 10.1 ↗ 8.59s 10.3 ↗ Serie 92 ( 2x) Total 92 ( 2x)	10 sek 2 serie	 2.27s 9.2 ↓ 4.49s 9.9 → 6.25s 8.9 → 7.60s 10.1 ↓ 8.81s 9.4 → 3.57s 10.0 → 5.07s 9.7 ↓ 6.60s 10.5x → 7.81s 10.7x ↗ 9.06s 10.3 ↓ Serie 94 ( 2x) Total 186 ( 4x)
8 sek 1 serie		2.18s 10.0 ↖ 3.57s 9.9 ↗ 4.54s 8.5 ↓ 5.60s 9.8 ← 6.81s 9.6 → 2.27s 9.4 ↓ 3.60s 9.7 ↑ 5.01s 9.1 ↓ 2.10s 9.7 → 6.97s 9.6 → Serie 90 ( 0x) Total 276 ( 4x)	8 sek 2 serie	 2.22s 9.2 → 3.38s 10.5x ↓ 4.53s 8.1 ↓ 5.50s 10.0 ↖ 6.54s 10.0 → 2.43s 10.2 → 3.69s 9.5 ↓ 5.25s 10.3 ↓ 6.72s 10.2 ↓ 7.79s 10.5x ↓ Serie 96 ( 2x) Total 372 ( 6x)
6 sek 1 serie		2.00s 10.5x ↑ 2.54s 8.9 ↑ 3.76s 9.8 ↓ 4.53s 10.0 ↗ 5.49s 10.4 ↑ 2.21s 10.7x → 3.25s 9.9 → 4.07s 9.2 ↑ 4.95s 10.2 ↓ 5.71s 10.6x → Serie 95 ( 3x) Total 467 ( 9x)	6 sek 2 serie	 2.68s 9.9 → 3.63s 9.7 → 4.49s 10.4 ↖ 5.33s 10.3 ↑ 6.19s 10.2 ↖ 2.14s 9.1 → 3.12s 9.8 → 3.93s 9.4 ↖ 4.68s 10.3 ↓ 5.49s 10.3 ↗ Serie 95 ( 0x) Total 562 ( 9x)

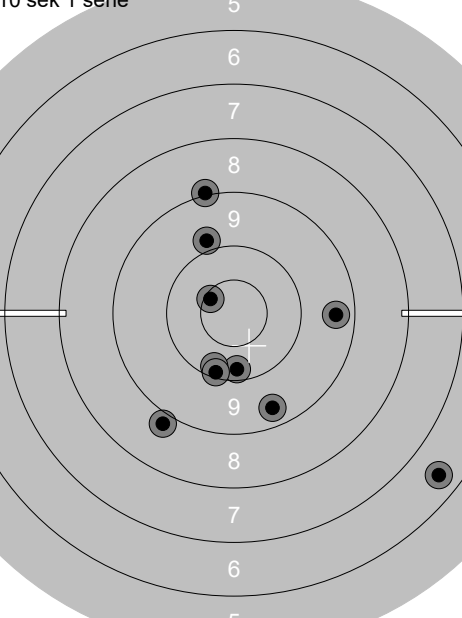
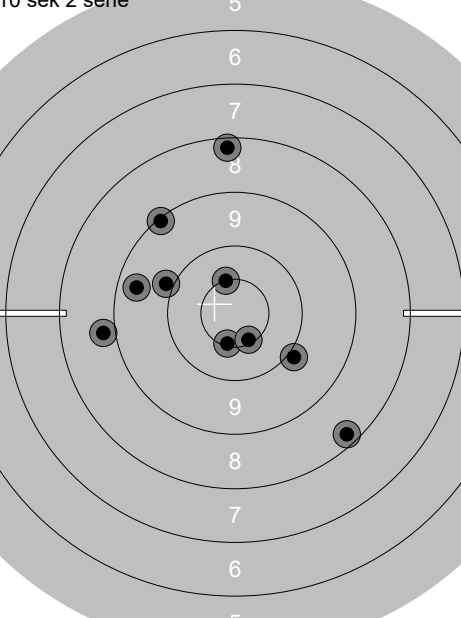
<p>10 sek 1 serie</p> 	<p>3.01s 9.0 ↑ 4.51s 10.6x ↙ 5.96s 10.2 ↓ 7.37s 9.4 → 8.81s 6.5 ↘ 3.13s 9.9 ↑ 4.38s 9.4 ↓ 5.76s 10.2 ↓ 7.16s 10.1 ↓ 8.76s 8.9 ↓</p> <p><b>Serie 90 ( 1x)</b></p> <p><b>Total 90 ( 1x)</b></p>	<p>10 sek 2 serie</p> 	<p>2.61s 8.2 ↑ 3.87s 10.0 ↘ 5.17s 8.9 ← 6.39s 10.5x ↓ 8.02s 9.4 ← 3.46s 10.5x ↑ 5.03s 9.9 ← 6.29s 9.1 ↑ 7.48s 10.5x ↓ 8.94s 8.3 ↘</p> <p><b>Serie 91 ( 3x)</b></p> <p><b>Total 181 ( 4x)</b></p>
--	---	--	--

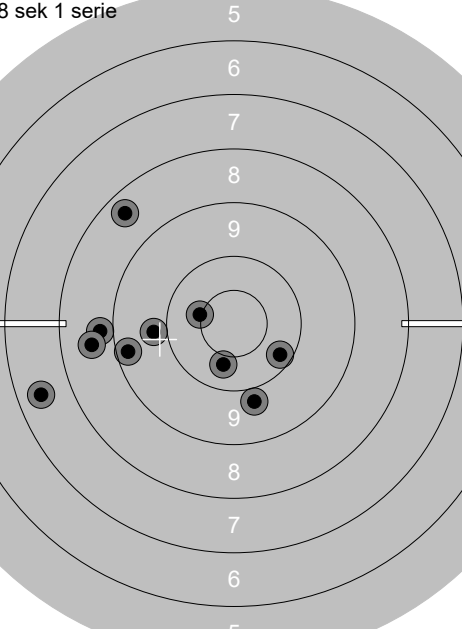
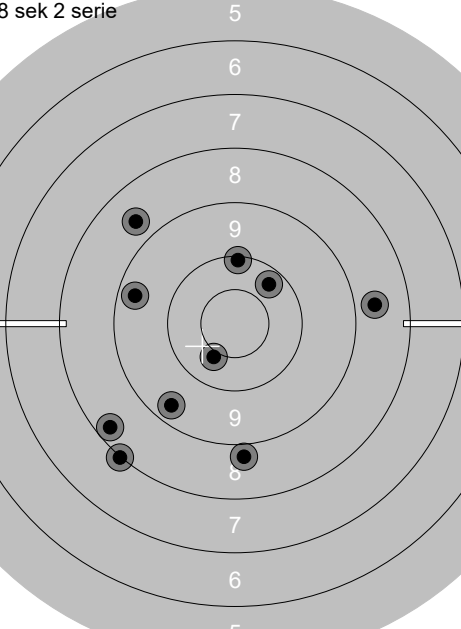
<p>8 sek 1 serie</p> 	<p>2.46s 8.4 ↘ 3.53s 10.5x ↙ 4.51s 9.3 ← 5.44s 8.8 ← 6.50s 9.8 ↓ 2.60s 10.4 ↓ 3.60s 9.8 ← 4.54s 8.7 ← 5.56s 10.2 ↘ 6.87s 7.5 ←</p> <p><b>Serie 88 ( 1x)</b></p> <p><b>Total 269 ( 5x)</b></p>	<p>8 sek 2 serie</p> 	<p>2.65s 8.7 ↘ 3.85s 8.8 ↓ 4.88s 9.4 ↘ 6.16s 8.7 → 7.32s 10.1 ↑ 2.39s 10.2 ↗ 3.53s 8.3 ↙ 4.62s 9.4 ← 5.74s 8.1 ↙ 6.96s 10.4x ↘</p> <p><b>Serie 88 ( 1x)</b></p> <p><b>Total 357 ( 6x)</b></p>
--	---	--	---

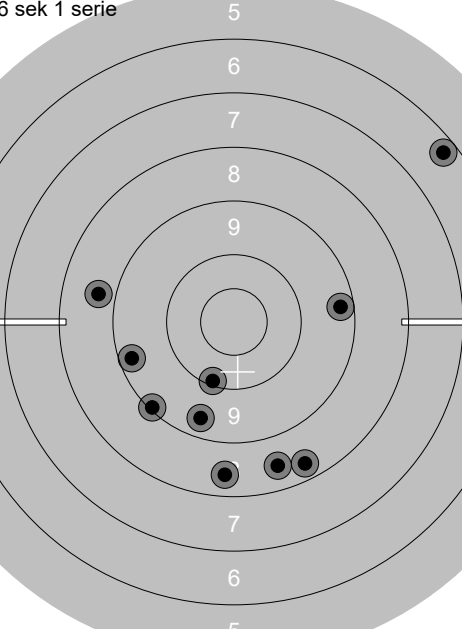
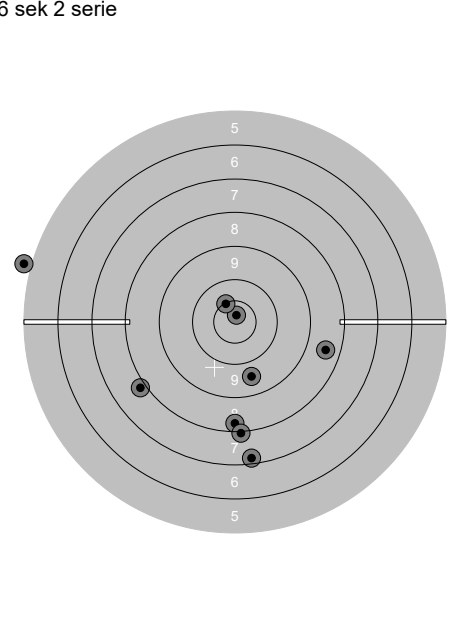
<p>6 sek 1 serie</p> 	<p>1.99s 8.7 ← 2.74s 9.1 ↙ 3.61s 9.3 ← 4.43s 8.5 ↓ 5.37s 9.4 ↓ 2.19s 10.1 ↓ 3.19s 6.3 ↗ 4.16s 9.3 → 5.07s 8.4 ↓ 6.00s 8.5 ↓</p> <p><b>Serie 84 ( 0x)</b></p> <p><b>Total 441 ( 6x)</b></p>	<p>6 sek 2 serie</p> 	<p>2.29s 8.3 ↓ 3.10s 9.6 ↓ 4.09s 8.5 → 4.93s 7.3 ↓ 5.99s 8.0 ↓ 2.22s 10.8x ↑ 4.46s 0.0 ← 5.05s 7.9 ← 5.72s 10.5x ↗</p> <p><b>Serie 67 ( 2x)</b></p> <p><b>Total 508 ( 8x)</b></p>
---	--	---	---



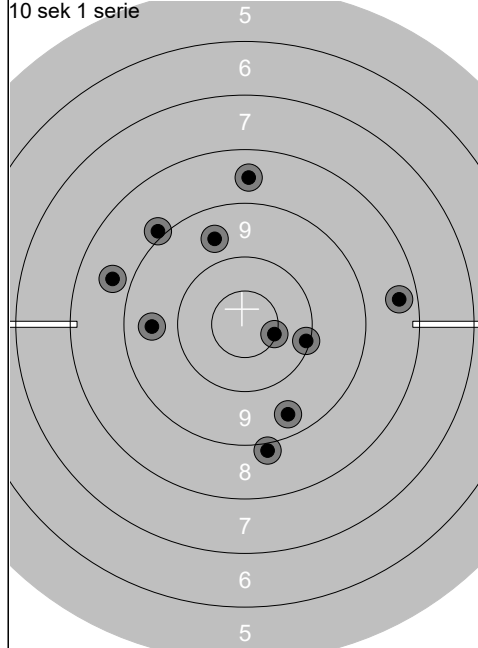

3.90s	8.7	←
5.07s	10.5x	⇒
6.15s	9.5	↓
7.13s	8.9	↗
8.36s	8.6	↑
4.26s	9.6	←
5.31s	10.1	⇒
6.48s	8.9	↓
7.49s	9.6	↗
8.73s	8.4	⇒
<b>Serie</b>	<b>87 ( 1x)</b>	
<b>Total</b>	<b>87 ( 1x)</b>	

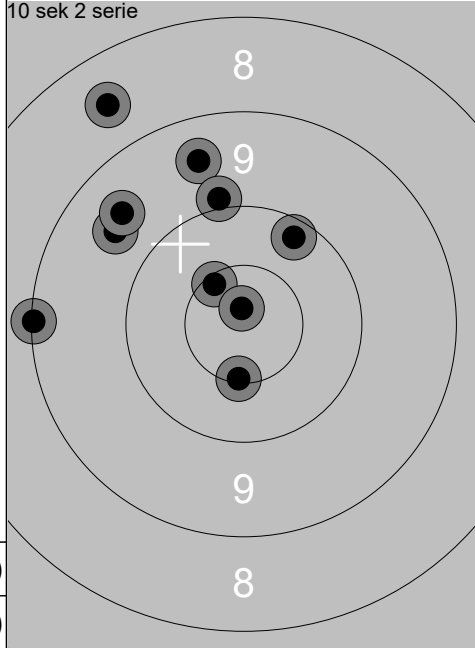

3.74s	10.6x	↖
4.83s	8.6	↖
6.10s	10.5x	↓
7.14s	9.5	↑
8.10s	10.2	↗
3.65s	9.6	↖
5.03s	10.8x	↑
6.03s	10.0	↑
7.74s	9.1	←
9.05s	9.6	↖
<b>Serie</b>	<b>94 ( 3x)</b>	
<b>Total</b>	<b>181 ( 4x)</b>	

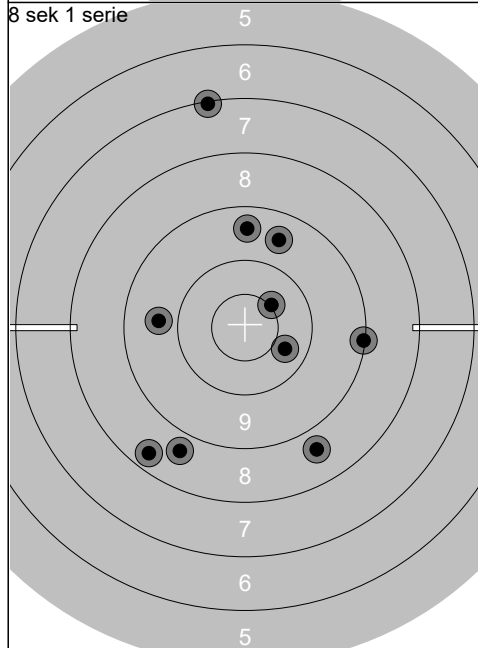

3.89s	9.6	↗
4.53s	8.7	↓
5.30s	10.3	⇒
6.72s	7.1	↑
7.36s	8.7	↓
3.08s	8.4	↘
3.95s	10.5x	↗
4.91s	9.5	↑
5.74s	9.1	⇒
6.68s	9.7	←
<b>Serie</b>	<b>87 ( 1x)</b>	
<b>Total</b>	<b>268 ( 5x)</b>	

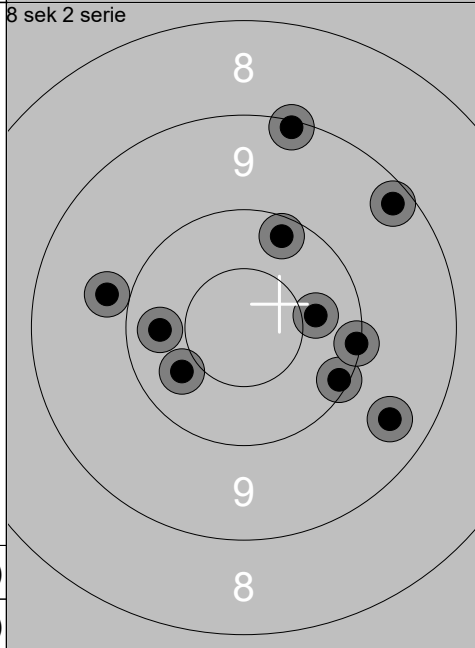

3.03s	9.8	←
4.05s	10.4	↙
4.95s	9.1	↑
5.95s	10.3	←
6.70s	10.1	⇒
2.49s	9.5	⇒
3.45s	10.1	⇒
4.51s	10.2	↗
5.39s	9.3	↗
6.54s	10.4	⇒
<b>Serie</b>	<b>96 ( 0x)</b>	
<b>Total</b>	<b>364 ( 5x)</b>	

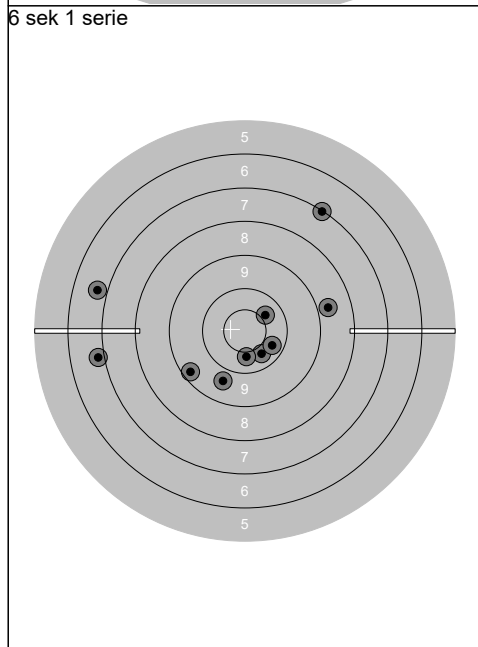

2.40s	10.3	↓
3.18s	6.9	←
3.87s	10.4	↓
4.66s	6.8	←
5.38s	9.7	↓
2.36s	10.3	⇒
3.71s	7.1	↗
4.30s	9.3	←
5.07s	8.8	⇒
5.77s	10.4	↗
<b>Serie</b>	<b>85 ( 0x)</b>	
<b>Total</b>	<b>449 ( 5x)</b>	

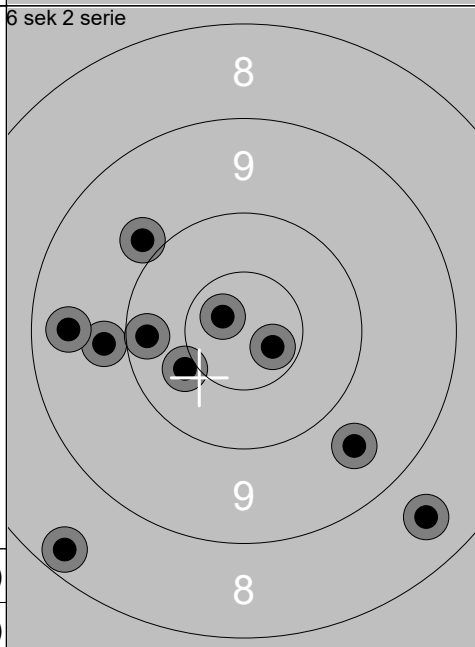

2.13s	9.8	←
2.88s	8.6	↓
3.67s	9.9	↗
4.48s	10.8x	↖
5.25s	10.2	←
3.04s	9.5	←
3.98s	9.6	↓
4.62s	10.4x	↙
5.27s	10.7x	⇒
5.97s	8.3	↘
<b>Serie</b>	<b>92 ( 3x)</b>	
<b>Total</b>	<b>541 ( 8x)</b>	

Lag	Skive	Tøger Rygh		
1	21			
Hurtigpistol Grov		Jørpeland Pk	V65	
25.06.2019		NM bane 2019	NM Pistol 2019	
10 sek 1 serie		3.25s 8.4 ↓ 4.33s 9.8 ↓ 5.43s 8.7 ↓ 6.52s 9.4 ↓ 7.67s 7.2 ↓ 3.35s 8.9 ← 4.46s 9.3 ← 5.52s 10.1 ← 6.77s 10.3 ← 7.82s 8.6 ← Serie 86 ( 0x) Total 86 ( 0x)	10 sek 2 serie 	3.64s 10.0 ↘ 4.79s 9.8 ← 5.85s 9.7 ↓ 6.75s 10.0 ↓ 7.95s 8.0 → 4.71s 8.2 ↙ 5.68s 9.1 ↘ 6.51s 10.4x ↖ 7.37s 9.9 ← 8.27s 10.3 ↓ Serie 92 ( 1x) Total 178 ( 1x)
8 sek 1 serie		3.13s 8.0 ← 4.29s 9.5 ↓ 5.13s 7.0 ↓ 5.96s 8.4 ↓ 6.84s 10.6x ↓ 2.84s 9.4 ← 3.82s 9.3 ↘ 4.96s 10.4 ↗ 5.84s 10.6x ← 6.78s 8.4 ↓ Serie 88 ( 2x) Total 266 ( 3x)	8 sek 2 serie 	2.97s 9.5 ↖ 3.97s 8.8 ↓ 5.01s 8.9 ↓ 6.38s 10.4x ↗ 7.33s 9.6 ↖ 2.98s 9.0 ← 4.26s 9.0 ↓ 5.14s 9.7 ↓ 6.04s 10.0 → 6.77s 9.0 ↖ Serie 90 ( 1x) Total 356 ( 4x)
6 sek 1 serie		2.15s 8.2 ↖ 2.92s 6.8 ↓ 3.69s 9.4 ↓ 4.59s 9.3 ← 5.35s 9.0 ← 2.38s 7.2 ← 3.38s 9.2 ← 4.12s 8.2 ↓ 4.91s 7.4 ← 5.72s 10.3 ↘ Serie 82 ( 0x) Total 438 ( 4x)	6 sek 2 serie 	2.61s 8.2 ← 3.67s 10.4 → 4.38s 8.3 ↓ 5.11s 6.9 ← 5.80s 8.7 ↓ 3.00s 8.4 ← 3.92s 9.4 ↓ 4.73s 10.0 ← 5.49s 7.8 ↓ 6.18s 6.9 ↗ Serie 80 ( 0x) Total 518 ( 4x)

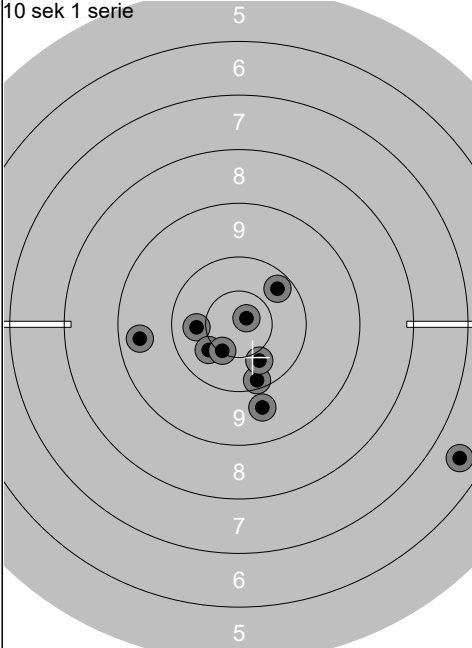
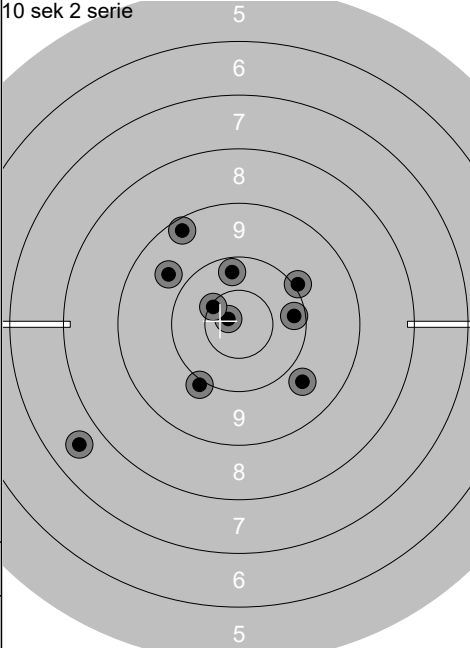
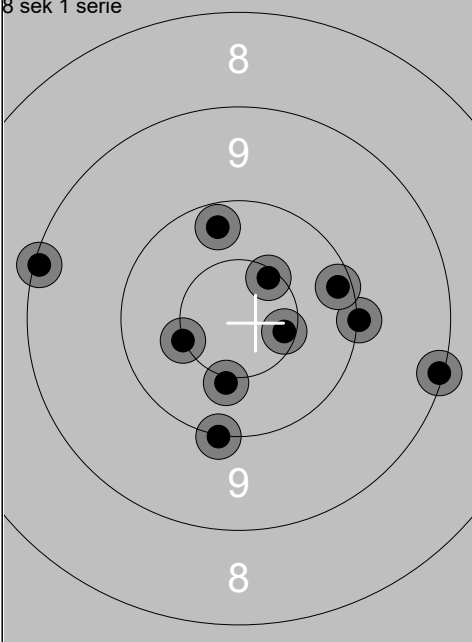
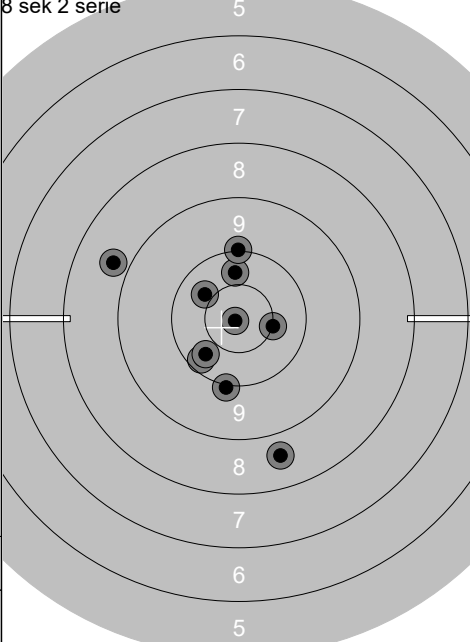
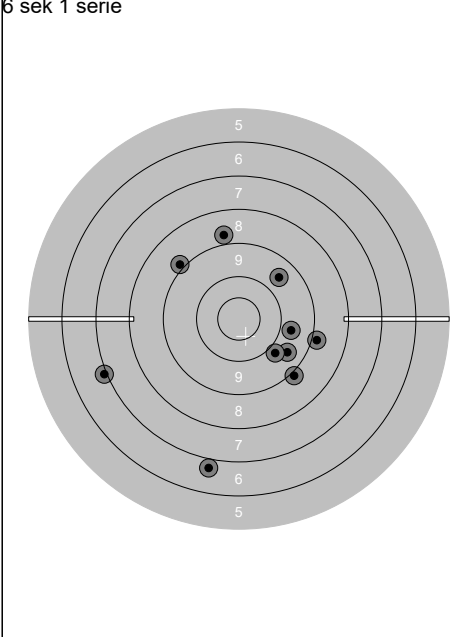
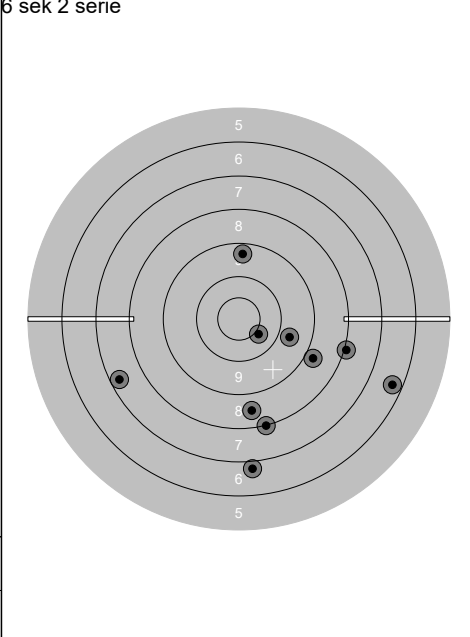
Lag	Skive	Terje Storholt	
1	22		
Hurtigpistol Grov		Oslo Pk	V65
25.06.2019		NM bane 2019	NM Pistol 2019
10 sek 1 serie		3.70s 10.2 ↘ 5.40s 10.2 ↗ 6.76s 6.5 ↘ 7.96s 10.4 ↘ 9.32s 9.7 ↘ 3.57s 10.4 ← 5.30s 10.4x ↙ 6.78s 10.8x ↗ 8.03s 9.5 ← 9.24s 10.5x ↘ Serie 94 ( 3x) Total 94 ( 3x)	10 sek 2 serie  4.00s 10.0 ↘ 5.67s 10.8x ↖ 6.91s 10.2 ↑ 8.36s 9.3 ↗ 9.57s 10.2 → 3.93s 10.0 ↗ 5.52s 10.5x ↖ 6.78s 9.7 ↖ 7.87s 9.7 ↘ 9.05s 7.6 ↙ Serie 94 ( 2x) Total 188 ( 5x)
8 sek 1 serie		3.71s 10.6x → 4.76s 10.0 → 5.77s 10.1 → 6.69s 10.6x ↗ 7.66s 10.0 ↘ 3.56s 9.1 → 5.17s 10.2 ↑ 6.27s 10.5x ↖ 7.19s 10.4x ↘ 8.19s 9.1 ← Serie 98 ( 4x) Total 286 ( 9x)	8 sek 2 serie  3.29s 10.4 ↖ 4.53s 10.2 ↘ 5.54s 8.7 ↘ 6.38s 8.8 ↖ 7.35s 10.3 ↘ 3.53s 10.9x ↖ 4.82s 10.5x → 5.70s 10.3 ↑ 6.35s 10.0 ↑ 7.22s 10.0 ↘ Serie 96 ( 2x) Total 382 ( 11x)
6 sek 1 serie		2.66s 9.7 → 3.50s 9.6 ↘ 4.11s 9.6 ↗ 4.67s 6.8 ↘ 5.26s 9.0 ↘ 2.68s 8.9 → 3.70s 8.9 ↗ 4.28s 8.8 ↑ 4.88s 9.8 ↘ 5.51s 7.0 ← Serie 82 ( 0x) Total 464 ( 11x)	6 sek 2 serie  2.63s 9.4 ↑ 3.45s 9.7 → 4.01s 8.1 ↘ 4.63s 8.6 ↘ 5.18s 6.9 ↘ 2.83s 6.4 → 3.73s 8.8 ↘ 4.50s 10.4x ↘ 5.09s 8.0 → 5.76s 7.4 ↙ Serie 79 ( 1x) Total 543 ( 12x)

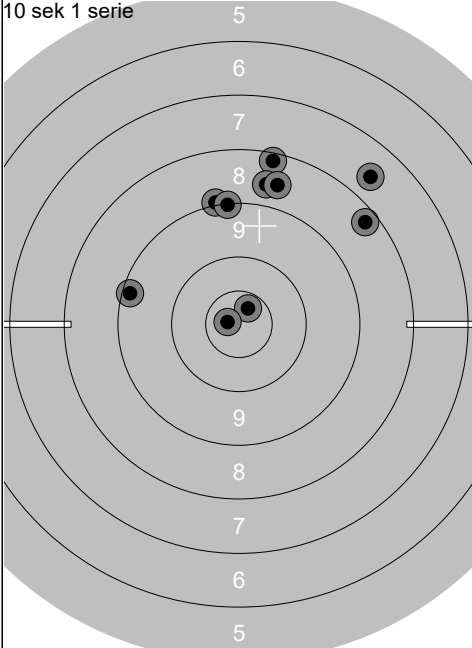
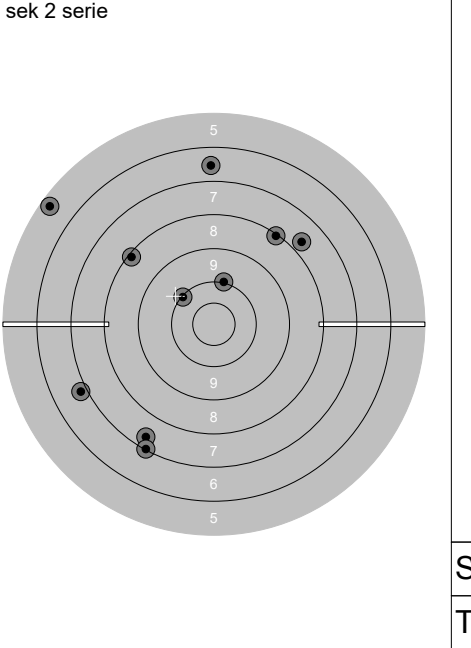
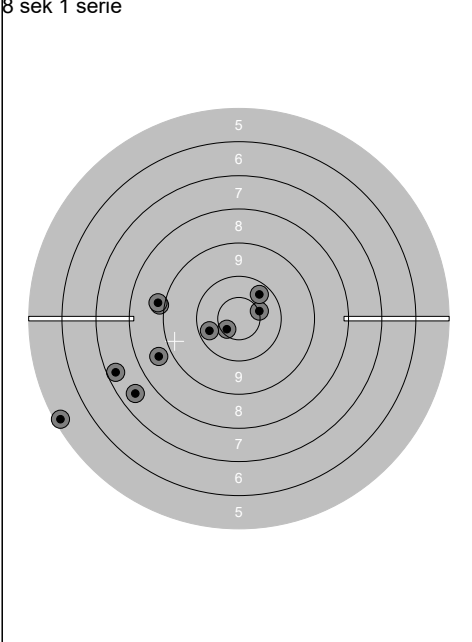
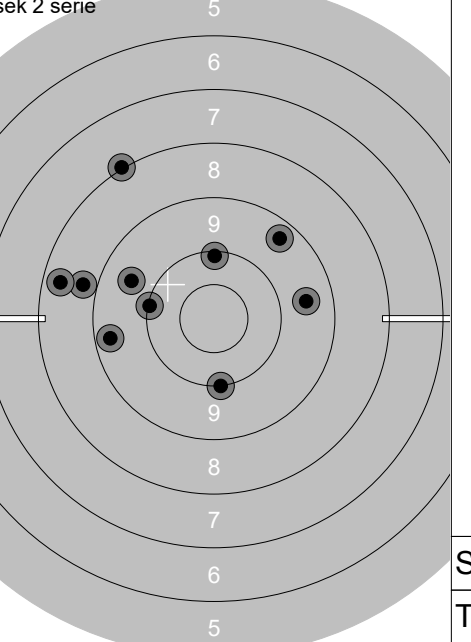
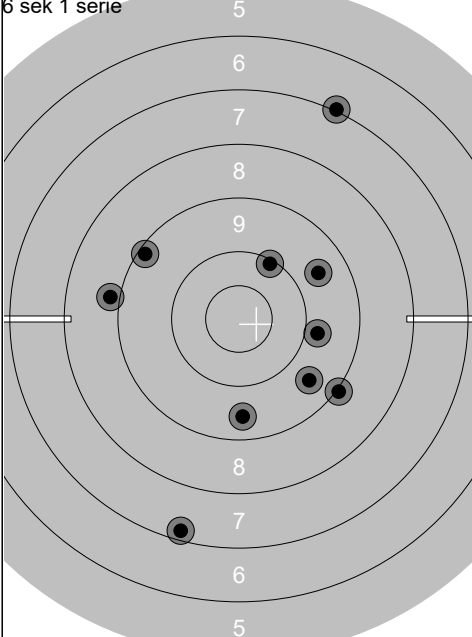
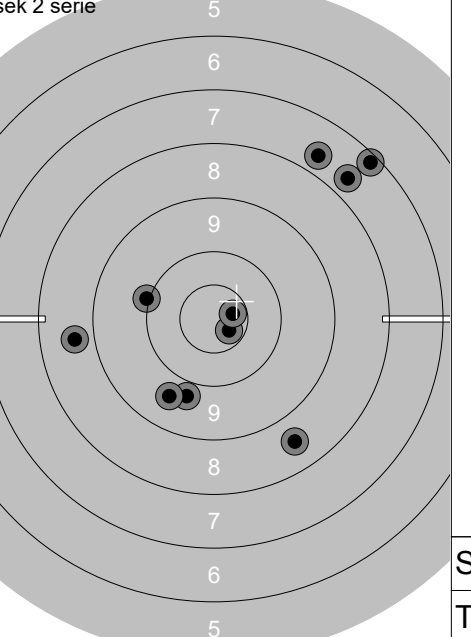
Lag	Skive	John Olav Sundal		
1	23			
Hurtigpistol Grov		Tysnes Sportskyttarklubb		
25.06.2019		V65		
25.06.2019		NM bane 2019	NM Pistol 2019	
10 sek 1 serie		2.90s 9.0 ↑ 4.15s 9.2 ← 6.19s 8.2 ↑ 7.28s 8.7 ↑ 8.33s 7.6 ↗ 2.97s 9.1 ↑ 4.23s 10.7x ↗ 5.39s 8.3 ↗ 6.55s 8.6 ↑ 7.83s 10.8x ← Serie 86 ( 2x) Total 86 ( 2x)	10 sek 2 serie 	3.58s 6.6 ↑ 5.16s 10.0 ↑ 6.39s 7.4 ↓ 7.70s 8.2 ↖ 8.84s 8.1 ↗ 2.54s 5.3 ↖ 3.78s 6.9 ← 4.73s 7.1 ↓ 6.13s 10.1 ↖ 7.27s 7.7 ↗ Serie 74 ( 0x) Total 160 ( 2x)
8 sek 1 serie		2.29s 8.9 ← 3.56s 8.9 ← 4.59s 10.6x ↙ 5.71s 8.7 ← 6.85s 10.5x → 2.68s 10.2 ← 3.91s 7.3 ← 5.01s 10.3 ↗ 6.25s 5.2 ← 7.39s 7.5 ← Serie 83 ( 2x) Total 243 ( 4x)	8 sek 2 serie 	3.47s 8.8 ← 4.74s 10.1 ← 5.86s 9.6 ← 6.78s 9.6 → 7.84s 10.1 ↑ 2.70s 9.4 ↗ 3.84s 9.4 ← 5.00s 10.0 ↓ 6.81s 8.0 ↖ 7.82s 8.4 ← Serie 90 ( 0x) Total 333 ( 4x)
6 sek 1 serie		2.02s 9.6 ↗ 3.00s 9.2 ↖ 3.90s 7.2 ↓ 4.76s 9.8 → 5.62s 7.0 ↗ 2.11s 9.5 ↓ 2.98s 9.6 ↘ 3.96s 8.9 ← 4.96s 10.1 ↗ 6.05s 9.0 ↘ Serie 86 ( 0x) Total 419 ( 4x)	6 sek 2 serie 	2.02s 10.7x ↘ 3.17s 9.8 ↓ 4.17s 7.7 ↗ 5.15s 9.7 ↓ 6.10s 7.2 ↗ 2.16s 7.7 ↗ 2.89s 8.7 ← 3.74s 10.0 ← 4.68s 8.6 ↓ 5.48s 10.7x → Serie 85 ( 2x) Total 504 ( 6x)

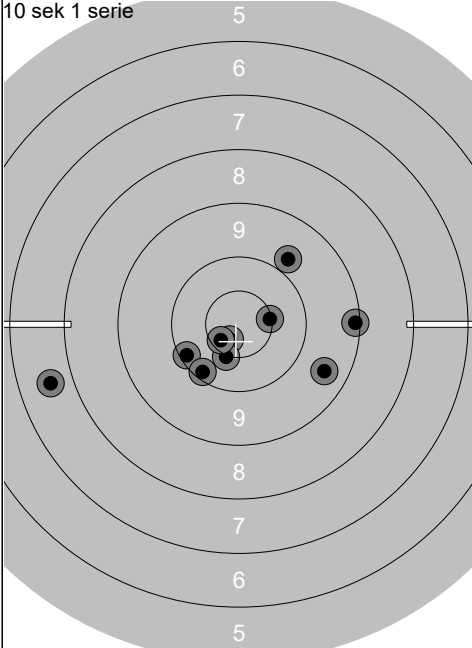
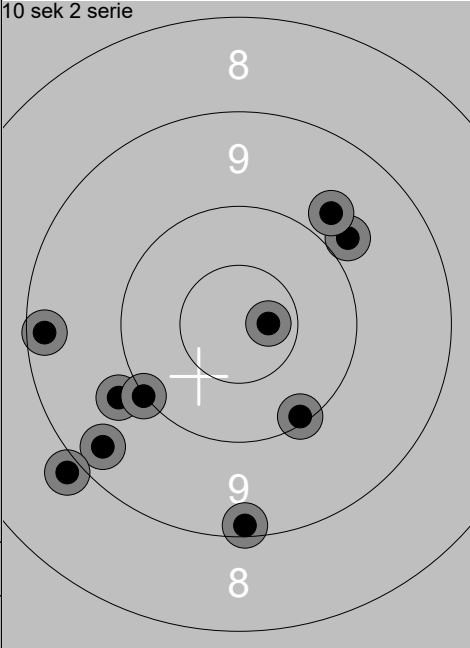
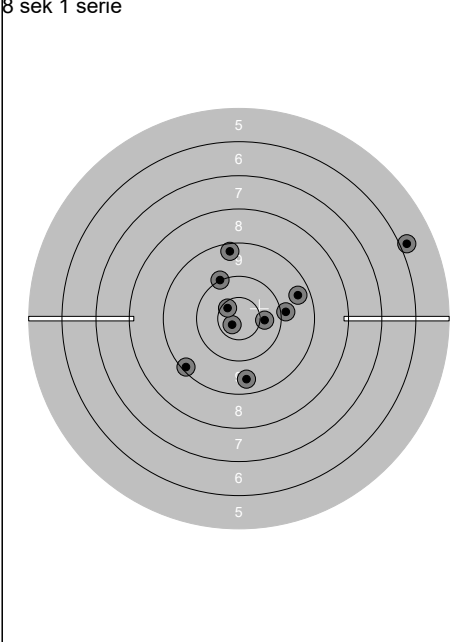
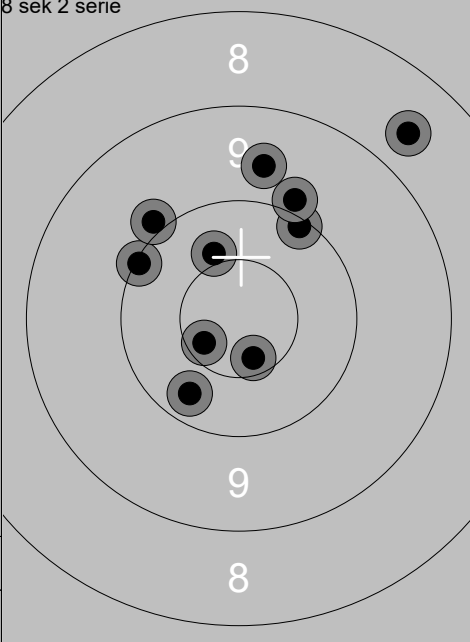
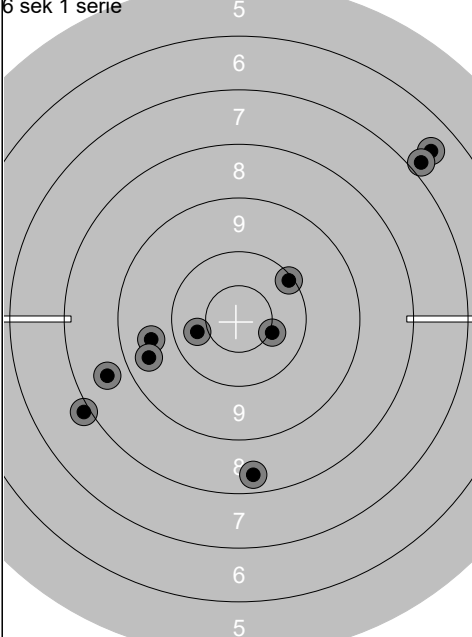
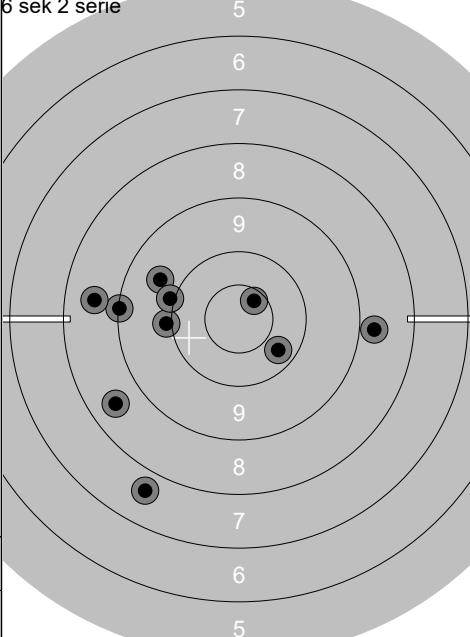
Lag	Skive	Jakob Kråkevik	
Hurtigpistol Grov	24	Odda Pk	V65
25.06.2019	NM bane 2019	NM Pistol 2019	
10 sek 1 serie		2.95s 7.7 ← 4.32s 10.1 ← 5.69s 9.2 → 7.01s 10.7x ↓ 8.41s 10.5x ↓ 2.93s 10.6x ← 4.37s 9.8 ↗ 5.58s 10.5x → 6.71s 9.5 → 7.83s 10.1 ↓ Serie 94 ( 4x) Total 94 ( 4x)	10 sek 2 serie
			
			3.08s 9.3 ← 4.30s 9.4 ↙ 5.43s 10.7x → 6.61s 9.8 ↗ 8.10s 8.9 ← 3.09s 9.8 ← 4.44s 10.0 ← 5.84s 10.1 ↓ 7.27s 9.8 ↗ 8.35s 9.2 ↓ Serie 92 ( 1x) Total 186 ( 5x)
8 sek 1 serie		2.52s 10.8x ← 3.62s 5.8 → 4.84s 9.3 ↑ 6.03s 10.0 ↗ 6.98s 10.6x ↖ 2.59s 9.5 ↓ 3.67s 10.4 → 4.80s 9.9 → 5.93s 9.2 ← 6.91s 9.4 → Serie 90 ( 2x) Total 276 ( 7x)	8 sek 2 serie
			
			2.48s 10.1 ↖ 3.74s 10.6x ↙ 4.68s 10.1 ↗ 5.75s 9.7 ↑ 6.80s 9.9 ↗ 2.40s 10.3 ↓ 3.48s 10.0 ↖ 4.40s 10.6x ↓ 5.47s 10.4x ↗ 6.49s 8.7 ↗ Serie 96 ( 3x) Total 372 ( 10x)
6 sek 1 serie		2.04s 8.0 ← 2.83s 10.1 ↗ 3.82s 10.4 ← 4.68s 10.5x → 5.57s 6.6 ↗ 2.10s 8.4 ↓ 3.11s 8.7 ← 4.15s 9.6 ← 4.88s 9.5 ← 5.80s 6.9 ↗ Serie 84 ( 1x) Total 456 ( 11x)	6 sek 2 serie
			
			2.10s 10.6x ↗ 3.03s 8.6 ← 3.86s 7.7 ↓ 4.76s 9.1 ← 5.53s 10.0 ← 2.09s 8.8 → 2.98s 9.7 ↖ 3.77s 10.0 ← 4.68s 8.6 ← 5.48s 10.3 ↓ Serie 89 ( 1x) Total 545 ( 12x)

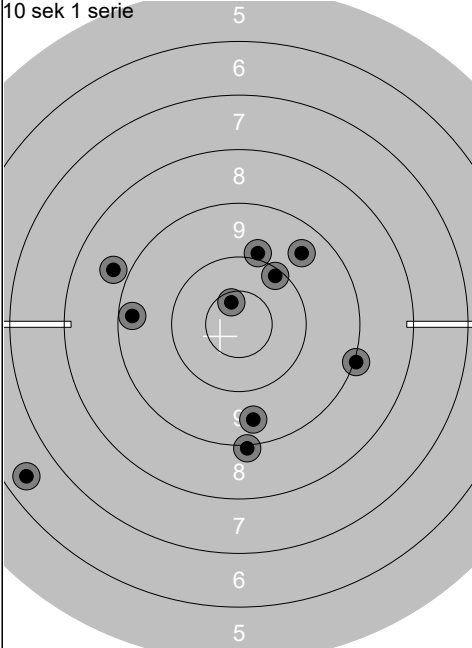
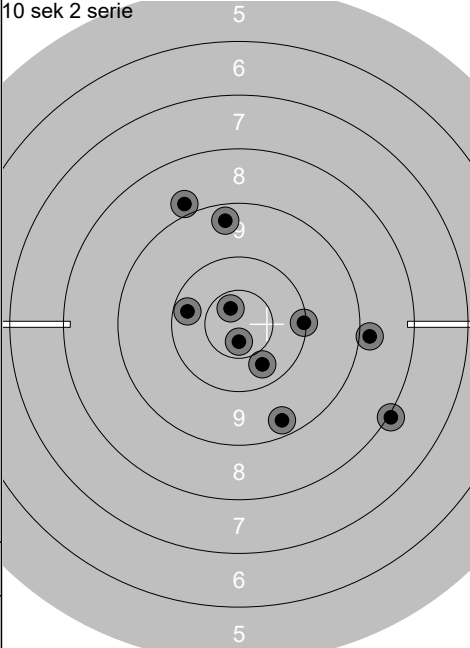
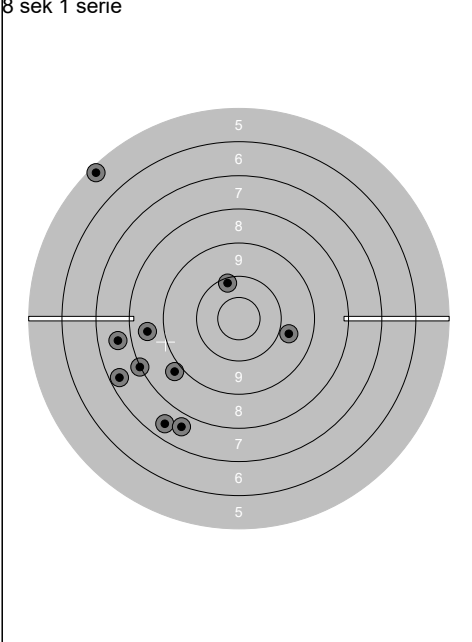
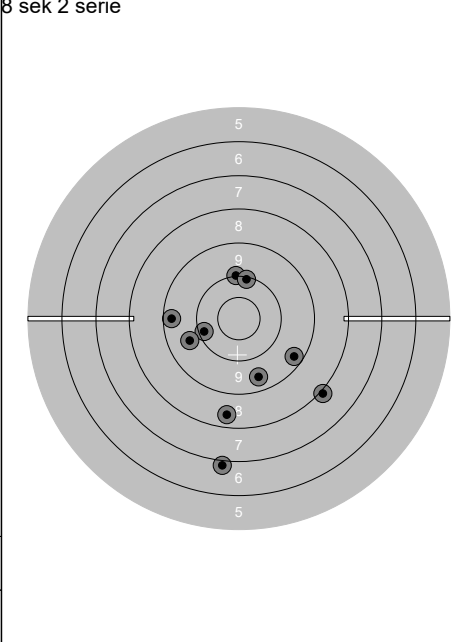
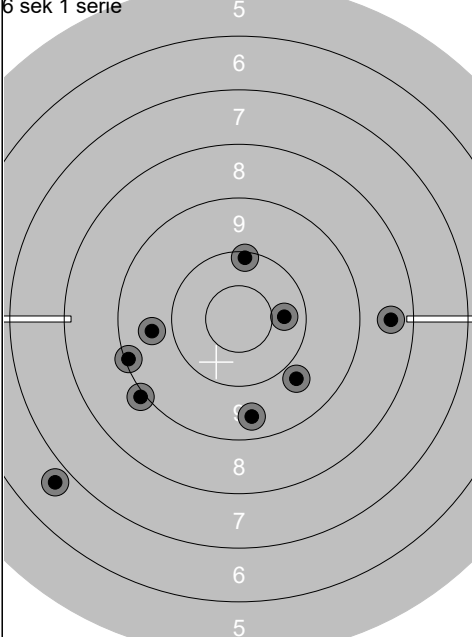
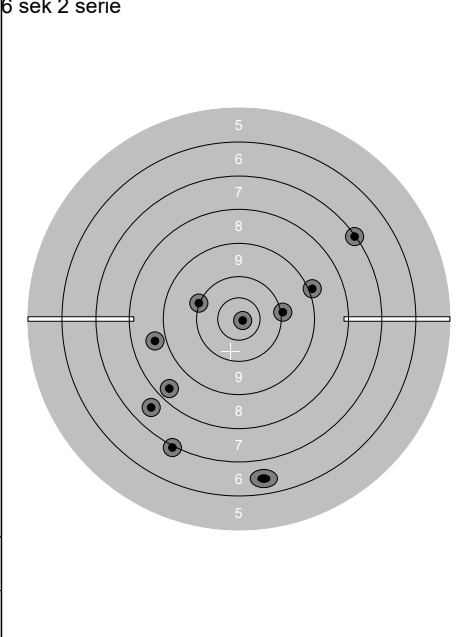
Lag	Skive	Tor Inge Brokjøb	
1	26		
Hurtigpistol Grov		Stavanger Pk	V73
25.06.2019		NM bane 2019	NM Pistol 2019
10 sek 1 serie		3.63s 6.5 ↙ 5.14s 10.6x ↗ 6.57s 9.0 → 7.89s 9.3 ← 9.15s 10.0 ↑ 3.30s 9.6 ↗ 4.59s 9.5 ↓ 5.89s 9.0 ↓ 7.20s 8.8 ↖ 8.51s 10.1 ↗ Serie 89 ( 1x) Total 89 ( 1x)	10 sek 2 serie  3.39s 10.2 ← 4.91s 10.7x ↗ 6.20s 8.9 ↗ 6.87s 10.1 → 8.42s 8.0 ↘ 4.90s 10.7x ↓ 6.06s 9.4 ↓ 7.25s 10.3 ↓ 8.16s 8.9 → 9.03s 9.4 ↑ Serie 92 ( 2x) Total 181 ( 3x)
8 sek 1 serie		3.15s 10.1 ↑ 4.51s 8.0 ← 5.78s 8.8 ↙ 6.95s 9.8 → 7.47s 5.3 ↗ 3.92s 7.5 ↓ 6.41s 7.7 ← 3.53s 7.7 ↓ 4.84s 8.6 ← 5.99s 7.4 ← Serie 76 ( 0x) Total 257 ( 3x)	8 sek 2 serie  2.46s 8.5 ↓ 3.65s 7.0 ↓ 4.84s 10.1 ← 5.94s 9.3 ↘ 7.00s 9.7 ← 3.01s 10.0 ↑ 4.23s 9.5 ↓ 5.56s 10.1 ↑ 6.75s 9.3 ← 7.82s 8.0 ↘ Serie 89 ( 0x) Total 346 ( 3x)
6 sek 1 serie		2.24s 10.1 ↑ 3.21s ☐ 4.13s 9.5 ↓ 4.99s 10.3 → 5.81s 9.1 ← 2.04s 6.8 ↙ 3.28s 8.5 → 4.38s 9.0 ↙ 5.36s 9.8 ↘ 6.20s 9.7 ← Serie 79 ( 0x) Total 425 ( 3x)	6 sek 2 serie  2.33s 9.0 ↗ 3.32s 10.0 → 4.30s 7.6 ↙ 5.14s 10.0 ← 5.92s 7.0 ↓ 2.93s 7.1 ↗ 3.90s 10.9x ↘ 4.80s 8.7 ← 5.62s 8.4 ↙ 0.12s ↗ Serie 76 ( 1x) Total 501 ( 4x)

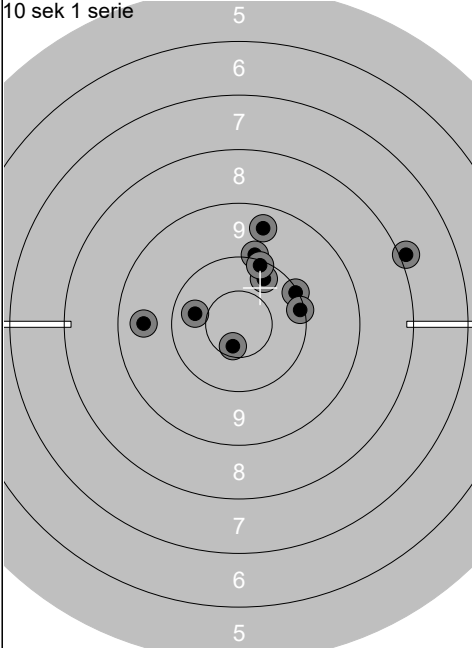
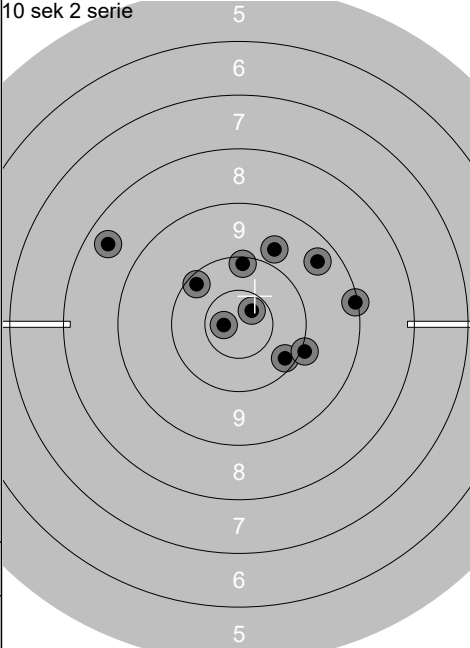
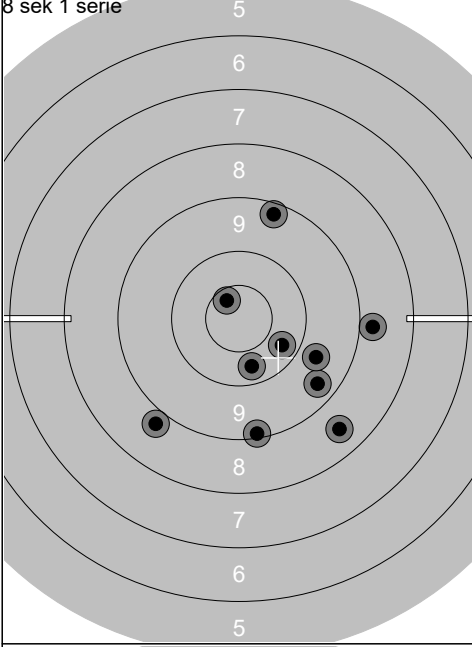
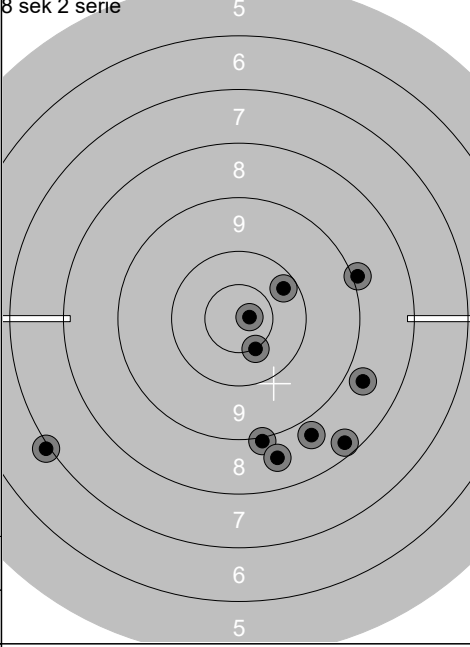
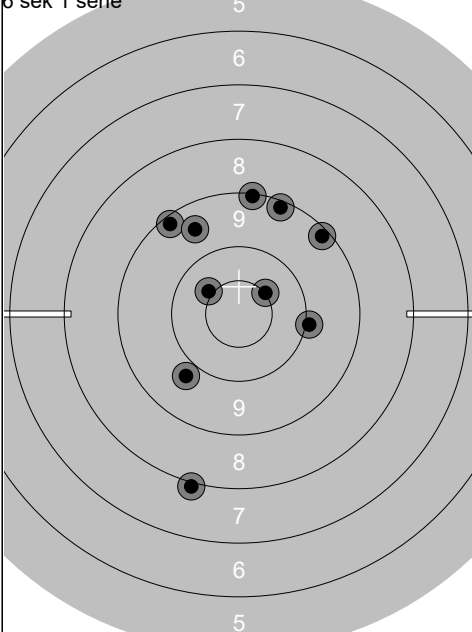
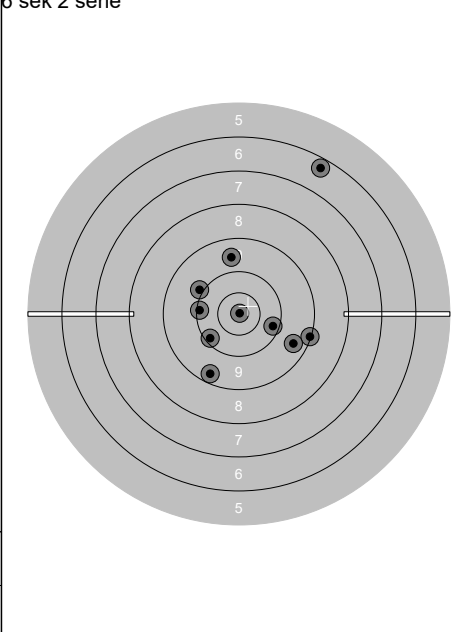
Lag	Skive	Bjørn Anton Jakobsen		
1	27			
Hurtigpistol Grov		Trondhjems Pk		
25.06.2019		V73		
25.06.2019		NM bane 2019	NM Pistol 2019	
10 sek 1 serie		10 sek 2 serie		
		2.41s 10.2 ↗ 3.97s 9.5 ↑ 5.39s 10.0 ↑ 7.30s 8.0 → 8.71s 10.1 → 2.52s 9.5 ← 4.01s 10.3 ← 5.43s 10.1 ↑ 6.89s 10.6x ↓ 8.49s 10.1 → Serie 96 ( 1x) Total 96 ( 1x)		2.64s 10.1 ↑ 3.96s 10.7x ← 5.39s 9.1 → 6.91s 8.5 ↖ 8.36s 10.2 ↘ 2.63s 9.8 ↑ 3.99s 10.2 ↖ 5.33s 10.7x ↗ 6.57s 10.0 → 8.28s 9.5 ↗ Serie 95 ( 2x) Total 191 ( 3x)
8 sek 1 serie		8 sek 2 serie		
		2.18s 10.3 ↓ 3.30s 10.3 ↘ 4.40s 9.2 ↓ 5.43s 8.8 → 6.62s 8.5 ↓ 2.12s 8.8 ↙ 3.40s 9.3 ↑ 4.62s 10.7x ↗ 5.91s 9.4 ↘ 7.07s 9.7 → Serie 90 ( 1x) Total 281 ( 4x)		2.17s 7.0 ↙ 3.59s 8.8 ↓ 4.88s 9.0 ↓ 6.17s 8.7 → 7.41s 10.8x → 2.25s 10.5x ↓ 3.49s 9.0 → 4.76s 10.2 ↗ 5.89s 8.3 ↓ 7.19s 8.6 ↓ Serie 87 ( 2x) Total 368 ( 6x)
6 sek 1 serie		6 sek 2 serie		
		2.00s 9.2 ↗ 2.95s 9.1 ↑ 3.76s 10.4x ↖ 4.67s 9.2 ↖ 5.55s 8.0 ↓ 2.06s 9.5 ↖ 2.92s 10.0 → 3.76s 9.8 ↙ 4.55s 10.5x ↗ 5.36s 9.2 ↑ Serie 92 ( 2x) Total 460 ( 8x)		1.94s 9.6 ↑ 2.88s 10.2 → 3.60s 10.1 ↙ 4.55s 6.4 ↑ 5.37s 10.9x → 1.92s 10.1 ← 2.78s 9.1 → 3.62s 9.3 ↓ 4.45s 10.0 ↖ 5.33s 9.5 → Serie 92 ( 1x) Total 552 ( 9x)

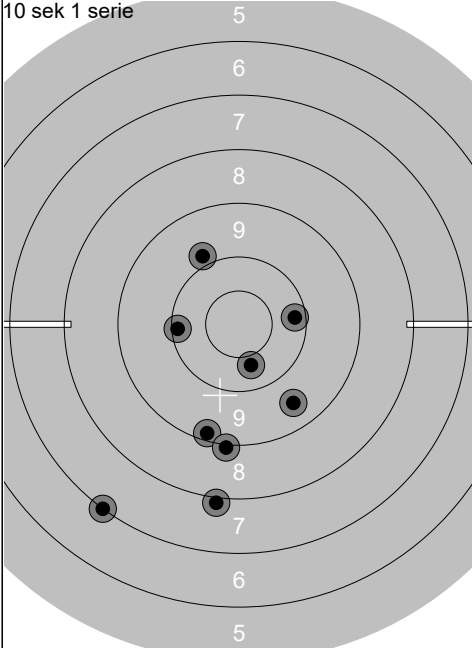
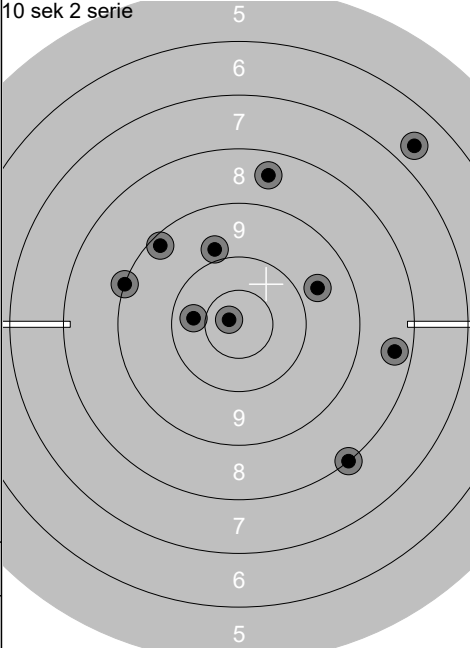
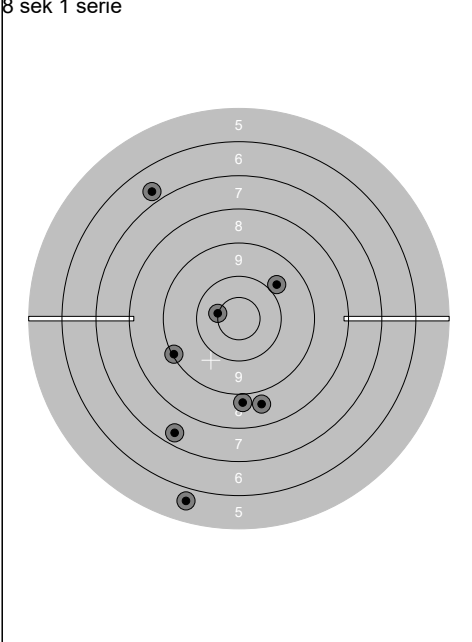
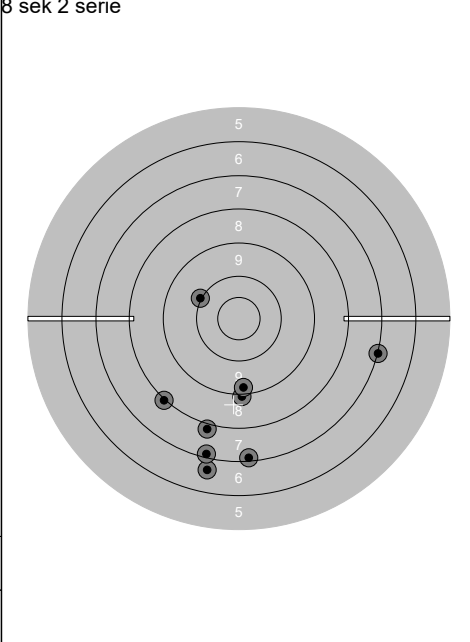
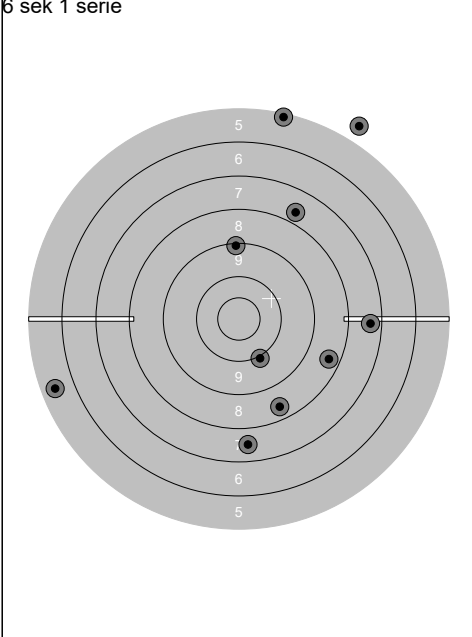
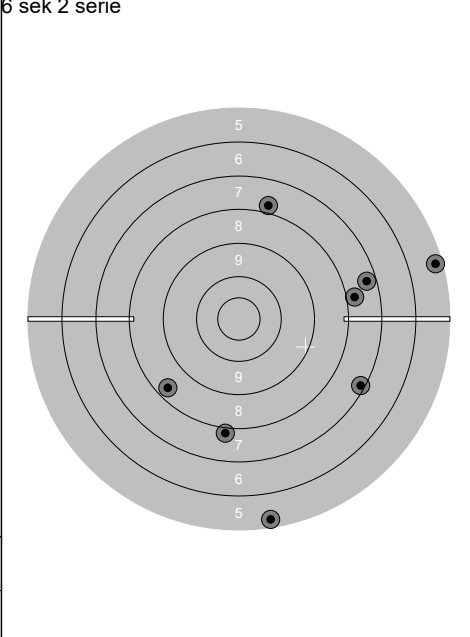
Lag	Skive	Thomas Michael Strøm	
1	28		
Hurtigpistol Grov		Sola PK	
25.06.2019		NM bane 2019	
10 sek 1 serie		NM Pistol 2019	
	2.48s 8.0 ↓ 3.53s 9.2 ↓ 4.69s 10.4 ↓ 5.70s ☒ 6.84s 10.1 ← 3.43s 9.9 ↗ 4.38s 10.2 → 5.39s 9.5 ↓ 6.51s 9.0 ↓ 7.51s 7.1 ↓ Serie 81 ( 0x) Total 81 ( 0x)		2.52s 6.7 ↗ 3.34s 9.1 ← 4.30s 9.3 ↗ 5.24s 10.8x ↖ 6.18s 8.5 ↑ 2.39s 9.7 ↗ 3.36s 8.1 ↓ 4.38s 8.4 → 5.48s 10.3 ← 7.19s 9.9 ↑ Serie 86 ( 1x) Total 167 ( 1x)
8 sek 1 serie	 2.31s 10.5x ↖ 3.23s 5.7 ↓ 4.16s ☒ 5.67s 6.7 ↗ 6.49s 8.8 ↓ 2.29s 8.7 ↓ 3.23s 9.1 ← 4.22s 9.8 ↗ 5.32s 7.4 ↓ 6.38s ☒ Serie 62 ( 1x) Total 229 ( 2x)	8 sek 2 serie	 2.39s 8.0 ↙ 3.27s 6.7 ↓ 4.26s 7.1 → 5.25s 7.2 ↓ 6.27s 7.2 ↓ 3.24s 7.9 ↓ 4.19s 10.0 ↖ 5.16s 9.0 ↓ 6.03s 9.3 ↓ -- Serie 70 ( 0x) Total 299 ( 2x)
6 sek 1 serie	 2.04s 5.5 ← 3.04s 0.0 ↗ 3.79s 7.4 → 4.58s 7.7 ↗ 5.32s 7.6 ↓ 2.16s 9.1 ↑ 3.05s 8.5 ↓ 4.00s 10.0 ↓ 5.09s 5.2 ↑ 6.03s 8.4 → Serie 66 ( 0x) Total 365 ( 2x)	6 sek 2 serie	 2.06s 8.4 ↙ 3.02s 7.2 → 3.82s 7.4 → 5.13s ☒ 5.96s 7.9 ↓ 2.10s 5.3 ↓ 3.80s 7.8 → 4.57s ☒ 5.25s 7.8 ↑ 6.01s 5.3 → Serie 53 ( 0x) Total 418 ( 2x)

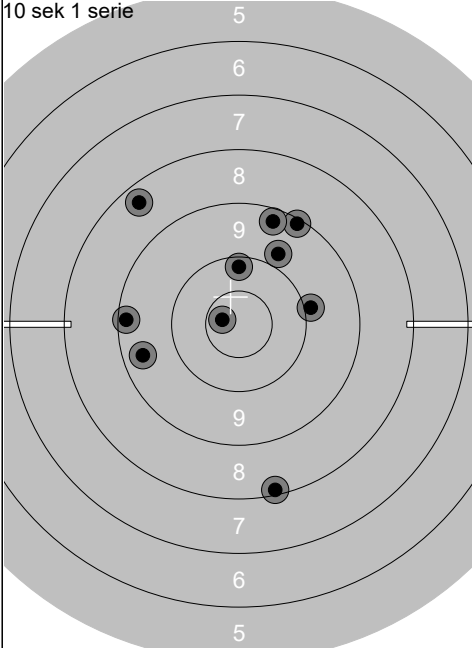
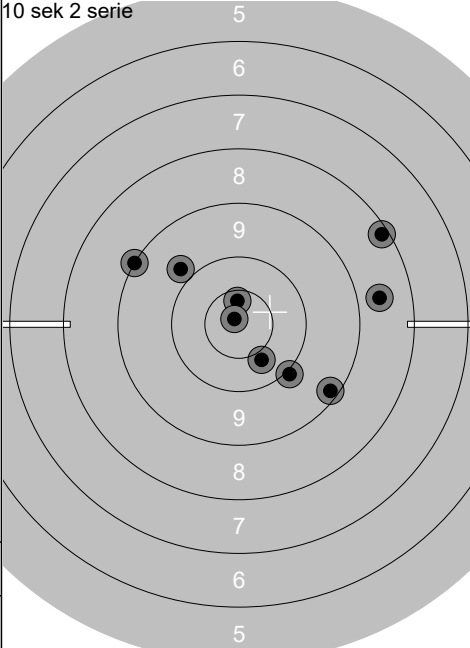
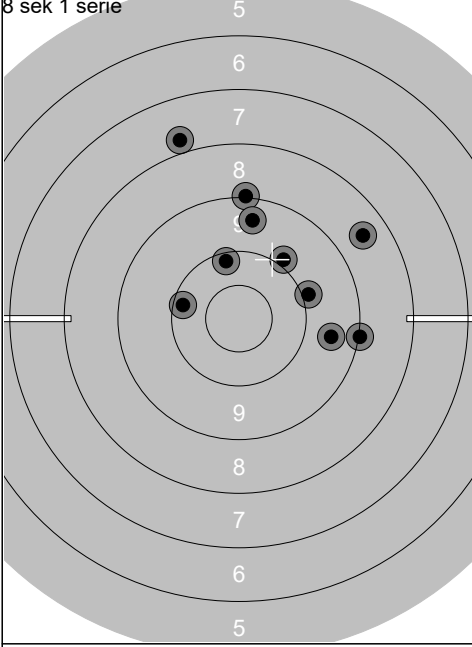
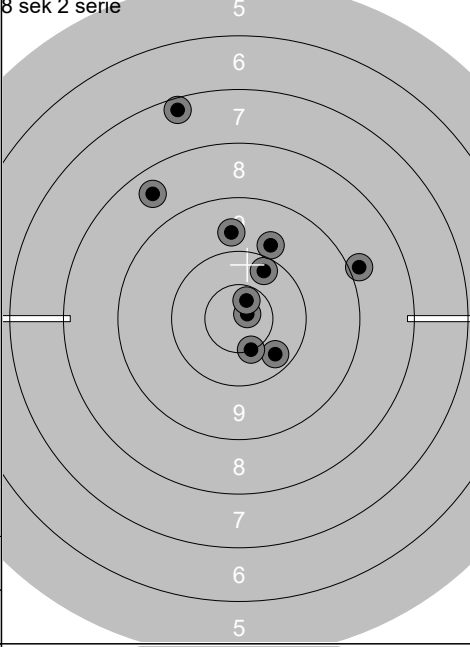
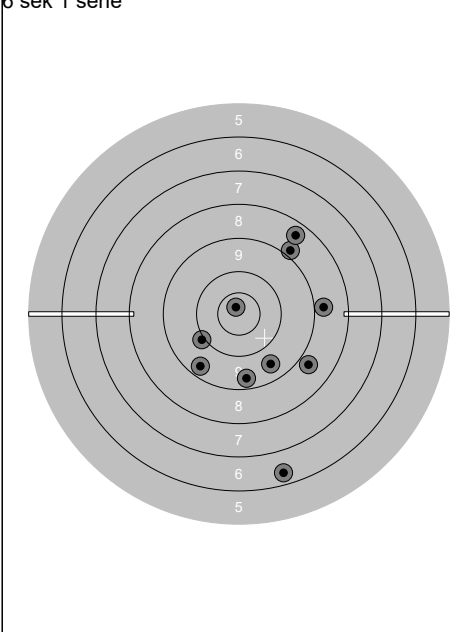
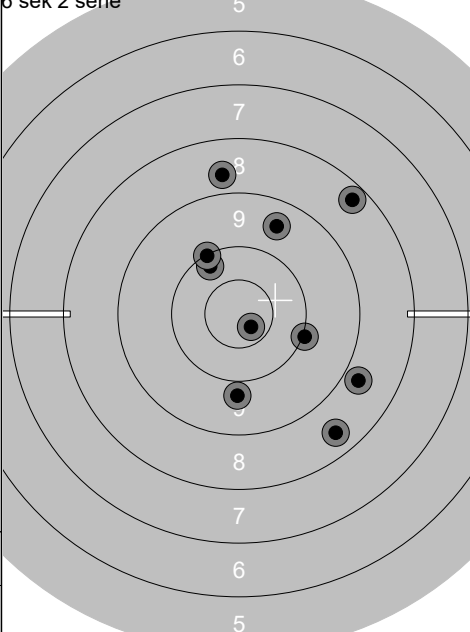

Lag	Skive	Roald Fuglestad	
1	29		
Hurtigpistol Grov		Hå Pk	
25.06.2019		NM bane 2019	NM Pistol 2019
10 sek 1 serie			
		2.68s 10.7x ← 4.26s 10.2 ↑ 5.22s 9.2 ← 6.71s 8.4 ↗ 7.49s 9.2 ↗ 3.06s 10.0 → 4.50s 9.4 ← 5.54s 9.3 ↑ 6.81s 8.2 ↓ 7.85s 9.8 ↗	3.20s 10.4 ↘ 4.36s 10.0 ↘ 5.58s 9.2 ↘ 6.79s 10.6x ↑ 7.86s 8.7 → 3.01s 10.9x ↗ 4.33s 9.8 ↗ 5.44s 9.1 ↖ 6.59s 8.2 ↗ --
		Serie 91 ( 1x)	Serie 83 ( 2x)
		Total 91 ( 1x)	Total 174 ( 3x)
8 sek 1 serie			
		2.39s 9.9 → 3.27s 7.8 ↑ 4.30s 9.0 ↑ 5.15s 10.2 ← 5.98s 10.0 ↗ 1.99s 9.6 → 3.29s 8.5 ↗ 4.26s 9.5 ↑ 5.35s 10.1 ↑ 6.35s 9.0 →	2.39s 8.9 → 3.57s 8.5 ↖ 4.62s 10.2 ↗ 5.83s 9.7 ↑ 6.64s 9.8 ↗ 2.12s 10.3 ↘ 3.53s 7.3 ↑ 4.53s 10.8x → 5.43s 10.5x ↓ 6.40s 10.7x ↗
		Serie 90 ( 0x)	Serie 91 ( 3x)
		Total 264 ( 3x)	Total 355 ( 6x)
6 sek 1 serie			
		1.79s 8.8 → 2.52s 8.9 ↗ 3.38s 8.4 ↗ 4.05s 8.8 ↘ 4.65s 9.4 ↘ 2.10s 10.0 ← 3.14s 9.6 ↘ 4.29s 10.8x ↗ 5.11s 9.4 ↓ 5.92s 6.4 ↓	1.98s 9.5 ↗ 2.98s 8.3 ↗ 4.45s 8.7 ↑ 5.32s 9.8 ↓ 6.02s 10.2 ↖ 2.16s 10.0 → 3.07s 10.1 ↗ 3.75s 8.5 ↘ 4.54s 10.7x ↘ 5.36s 8.8 ↘
		Serie 85 ( 1x)	Serie 90 ( 1x)
		Total 440 ( 7x)	Total 530 ( 8x)

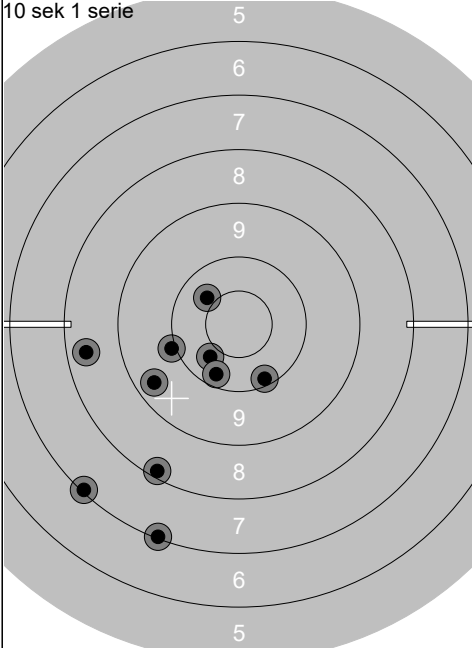
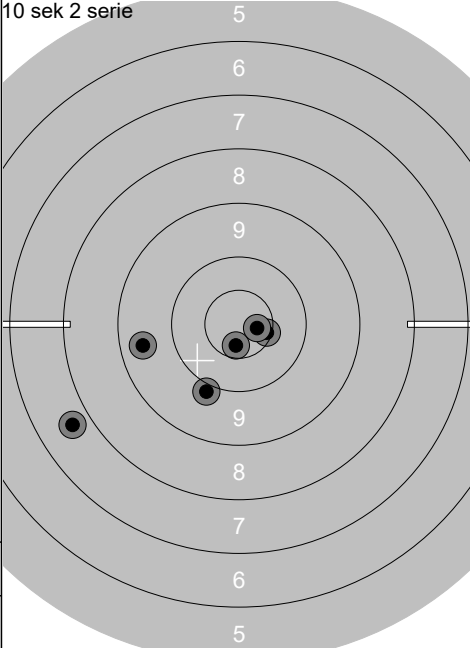
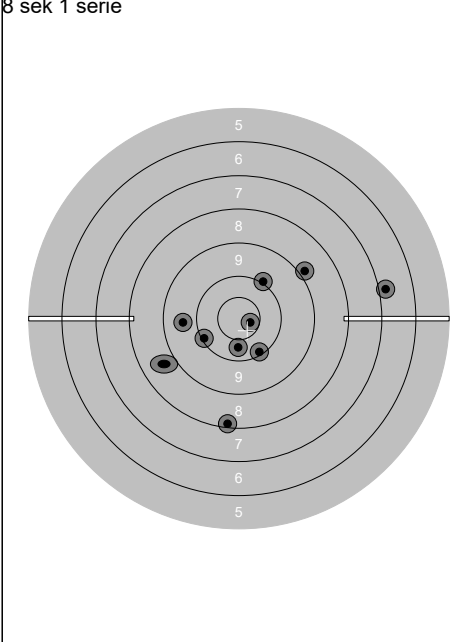
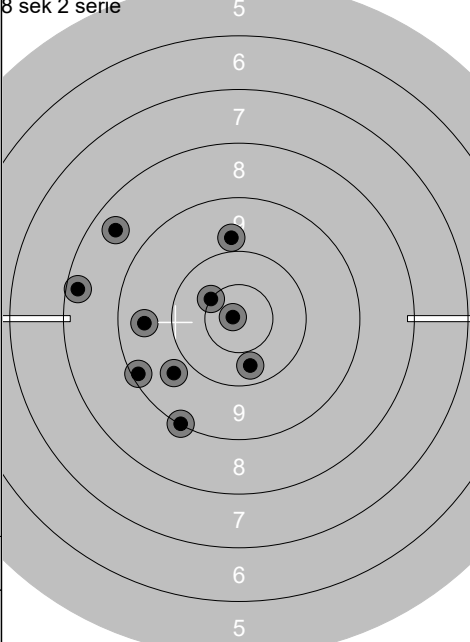
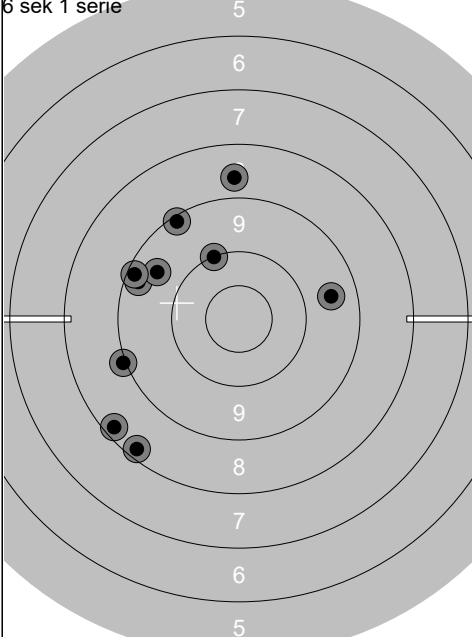
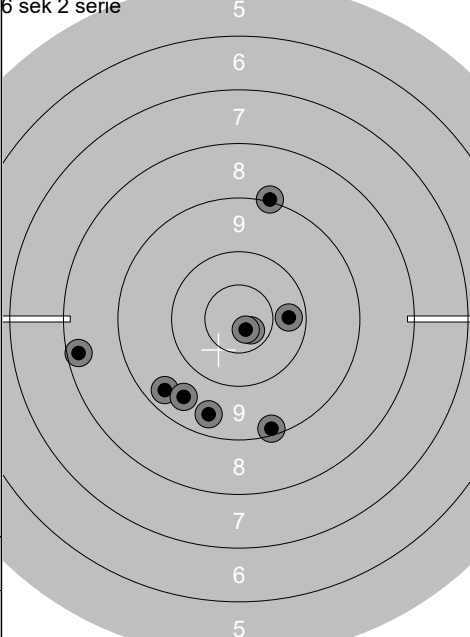
Lag	Skive	Stian Alexander Andersen			
1	30				
Hurtigpistol Grov		Trondheim Sportsskyttere			
25.06.2019		NM bane 2019			
		NM Pistol 2019			
10 sek 1 serie 	2.12s	10.4 ↖	10 sek 2 serie 	2.21s	9.9 ↘
	3.20s	10.0 ←		3.69s	10.6x →
	4.30s	8.4 ←		5.12s	10.7x ↓
	5.45s	8.2 ↘		6.57s	7.7 ←
	6.70s	10.1 ↘		7.97s	10.7x →
	2.29s	7.1 ↘		2.24s	9.5 ←
	3.53s	9.4 ←			--
	4.90s	10.4 ↘			--
	6.21s	10.2 ↘			--
	7.41s	7.1 ↘			--
Serie	89 ( 0x)		Serie	55 ( 3x)	
Total	89 ( 0x)		Total	144 ( 3x)	
8 sek 1 serie 	2.27s	10.1 ↘	8 sek 2 serie 	2.16s	9.7 ↖
	3.56s	10.1 ←		3.38s	10.3 ↓
	4.90s	10.7x →		4.80s	9.2 ←
	6.19s	10.3 ↓		5.96s	9.6 ←
	7.40s	8.2 ↓		7.22s	9.1 ↘
	2.44s	10.0 ↗		2.12s	8.3 ←
	7.00s	8.9 ↗		3.30s	10.5x ↖
	7.57s	9.7 ←		4.47s	9.8 ↑
	8.00s	6.9 →		5.58s	8.5 ↖
	0.13s	↖		6.58s	10.9x ←
Serie	81 ( 1x)		Serie	91 ( 2x)	
Total	225 ( 4x)		Total	316 ( 6x)	
6 sek 1 serie 	1.95s	9.6 →	6 sek 2 serie 	1.94s	☒
	2.86s	9.2 ↖		2.97s	9.0 ↑
	3.61s	8.7 ↑		3.98s	10.7x ↘
	4.43s	9.3 ←		4.99s	10.3 →
	5.21s	9.6 ↖		5.80s	8.3 ←
	2.02s	8.3 ←		2.17s	9.5 ↘
	3.34s	9.0 ←		3.18s	9.2 ↘
	4.20s	10.0 ↗		4.18s	9.4 ↖
	5.09s	9.2 ↖		5.13s	9.5 ↘
	5.89s	8.2 ↘		5.97s	10.8x ↘
Serie	88 ( 0x)		Serie	83 ( 2x)	
Total	404 ( 6x)		Total	487 ( 8x)	

<p>10 sek 1 serie</p>	<p>2.64s 10.3 →</p> <p>4.11s 9.6 ←</p> <p>5.36s 9.8 ↘</p> <p>6.66s 9.9 ←</p> <p>7.84s 10.2 ↘</p> <p>3.03s 10.2 ↗</p> <p>4.33s 10.1 ↖</p> <p>5.51s 9.7 ←</p> <p>6.80s 10.1 ↖</p> <p>8.16s 9.8 ↓</p> <p>Serie 95 ( 0x)</p> <p>Total 95 ( 0x)</p>	<p>10 sek 2 serie</p>	<p>2.77s 8.8 →</p> <p>4.05s 9.7 ↓</p> <p>5.69s 10.6x ↗</p> <p>6.88s 10.7x ↗</p> <p>8.30s 9.4 →</p> <p>2.74s 9.1 ↘</p> <p>3.89s 10.0 →</p> <p>5.33s 9.3 ↗</p> <p>6.73s 10.1 ↗</p> <p>7.80s 10.4x ↖</p> <p>Serie 94 ( 3x)</p> <p>Total 189 ( 3x)</p>
-----------------------	--	-----------------------	--

<p>8 sek 1 serie</p>	<p>2.27s 9.4 ↘</p> <p>3.19s 9.4 ↓</p> <p>3.99s 10.4 →</p> <p>4.93s 10.2 ↖</p> <p>5.72s 10.5x ↘</p> <p>2.24s 8.5 ↓</p> <p>2.96s 7.4 ↓</p> <p>4.17s 10.5x ↘</p> <p>4.95s 8.2 ↓</p> <p>5.66s 7.8 ↘</p> <p>Serie 88 ( 2x)</p> <p>Total 277 ( 5x)</p>	<p>8 sek 2 serie</p>	<p>3.34s 9.9 ←</p> <p>4.40s 10.0 →</p> <p>5.23s 10.4x ↗</p> <p>6.19s 10.3 ↘</p> <p>7.11s 9.3 →</p> <p>2.59s 10.1 ↓</p> <p>3.40s 9.4 ↓</p> <p>4.32s 10.5x ↘</p> <p>5.07s 9.1 →</p> <p>5.80s 8.7 ↘</p> <p>Serie 94 ( 2x)</p> <p>Total 371 ( 7x)</p>
----------------------	--	----------------------	---

<p>6 sek 1 serie</p>	<p>1.96s 6.3 ↓</p> <p>2.54s 8.9 ↓</p> <p>3.43s 8.9 ↖</p> <p>4.05s 8.8 ↘</p> <p>4.82s 7.8 ↓</p> <p>2.23s 8.5 →</p> <p>3.03s 10.0 ←</p> <p>3.88s 10.7x ↖</p> <p>4.69s 7.7 →</p> <p>5.44s 9.2 →</p> <p>Serie 81 ( 1x)</p> <p>Total 452 ( 8x)</p>	<p>6 sek 2 serie</p>	<p>2.41s 9.7 ↓</p> <p>3.17s 10.4 →</p> <p>3.84s 10.4 ↗</p> <p>4.53s 9.7 ↘</p> <p>5.29s 9.3 ↖</p> <p>2.04s 8.6 ↓</p> <p>2.73s 8.5 ↓</p> <p>3.39s 8.7 ↓</p> <p>4.17s 8.5 ↖</p> <p>5.34s 9.6 ↓</p> <p>Serie 80 ( 0x)</p> <p>Total 532 ( 8x)</p>
----------------------	---	----------------------	--

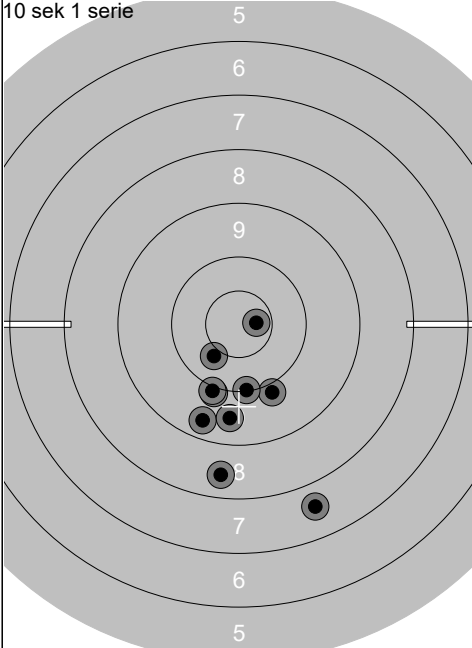
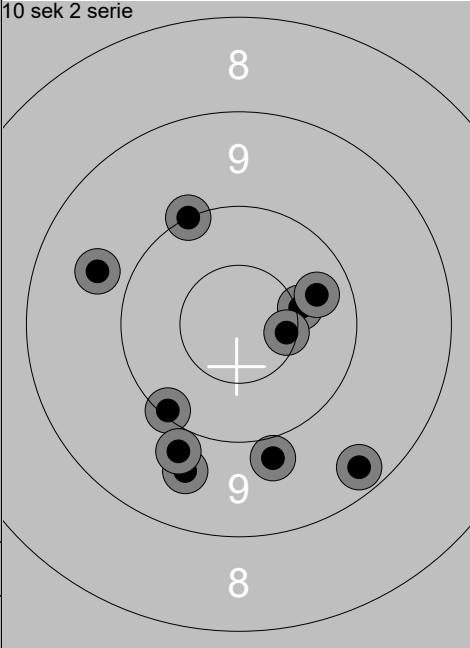
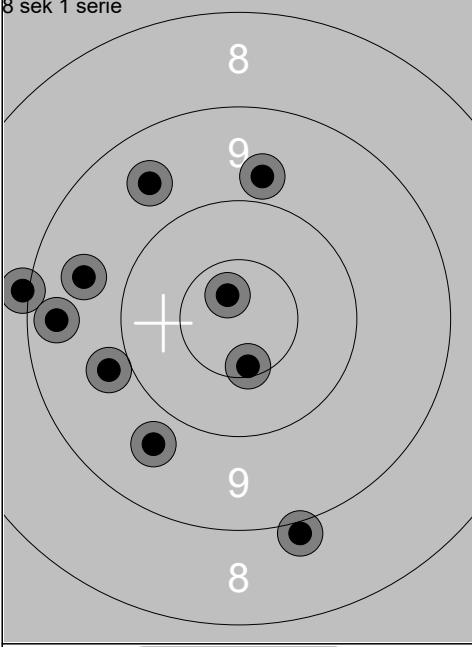
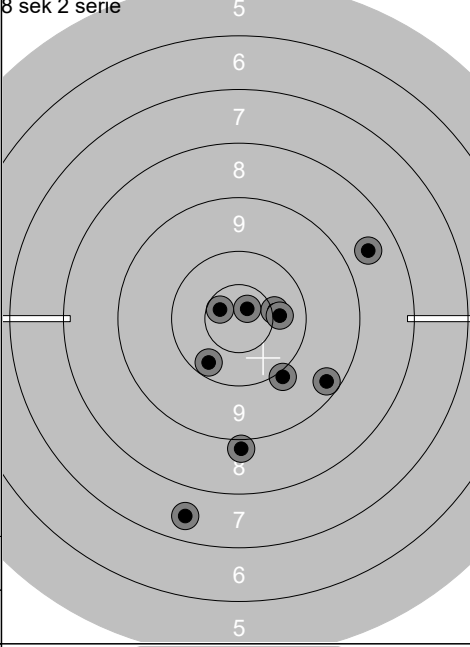
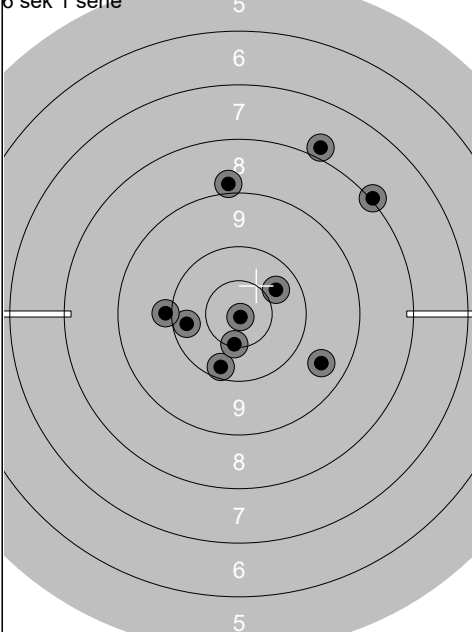
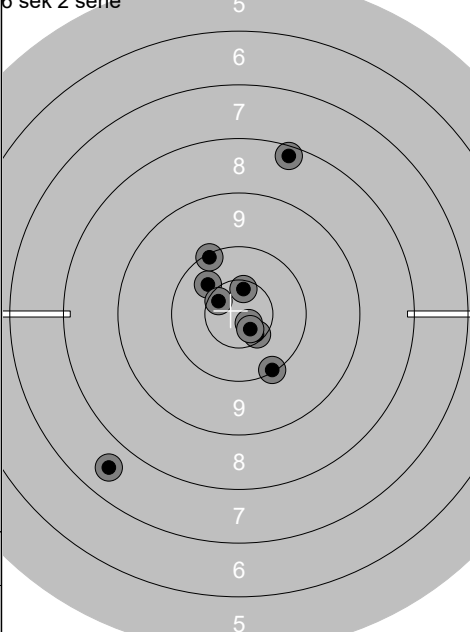
Lag	Skive	Erik Christian Bache	
1	32	Åsane Pk	Å
25.06.2019		NM bane 2019	NM Pistol 2019
10 sek 1 serie		2.50s 9.9 ↘ 3.72s 7.7 ↘ 5.25s 10.4x ↘ 6.32s 10.0 ↘ 7.43s 10.1 ↘ 2.58s 8.5 ↘ 3.48s 9.4 ↘ 4.88s 10.0 ↘ 5.90s 9.6 ↘ 6.86s 10.7x → Serie 92 ( 2x) Total 92 ( 2x)	10 sek 2 serie  2.60s 9.7 ↖ 3.90s 9.9 ↘ 5.27s 9.7 ↘ 6.63s 9.3 ↘ 7.81s 10.1 ↘ 2.04s 10.5x → 3.31s 9.8 ↘ 4.67s 10.0 ↗ 5.94s 10.6x → 6.99s 10.3 → Serie 95 ( 2x) Total 187 ( 4x)
8 sek 1 serie		2.16s 9.6 ↖ 3.19s 9.6 ↗ 4.22s 9.7 ↘ 5.34s 9.8 ↖ 6.23s 9.8 ↗ 2.33s 10.6x ↘ 3.53s 9.0 ↘ 4.78s 10.7x ↗ 6.07s 9.0 ↖ 7.19s 9.4 ↖ Serie 92 ( 2x) Total 279 ( 6x)	8 sek 2 serie  2.58s 8.9 ↘ 3.81s 10.5x → 5.23s 10.0 ↘ 6.04s 8.6 ↗ 6.89s 10.4 → 2.45s 9.3 ↘ 3.52s 7.5 ↘ 4.65s 10.2 ↘ 5.59s 10.8x ↗ 6.64s 10.7x ↖ Serie 92 ( 3x) Total 371 ( 9x)
6 sek 1 serie		1.87s 10.2 ↘ 2.63s 10.5x ↘ 3.53s 9.5 ↘ 4.18s 10.4 ↗ 5.04s 7.9 ↗ 1.82s 10.2 ↖ 2.66s 10.0 ↖ 3.32s 8.0 ↗ 4.26s 8.9 ↗ 5.33s 10.9x ↘ Serie 92 ( 2x) Total 463 (11x)	6 sek 2 serie  1.99s 10.1 ↘ 2.72s 10.6x ↘ 3.59s 10.4 ↗ 4.59s 10.8x ↘ 5.46s 10.7x ↘ 1.91s 7.6 ↘ 2.58s 10.1 ↗ 3.40s 8.2 ↗ 4.44s 10.6x ↖ 5.19s 10.6x ↗ Serie 95 ( 5x) Total 558 (16x)

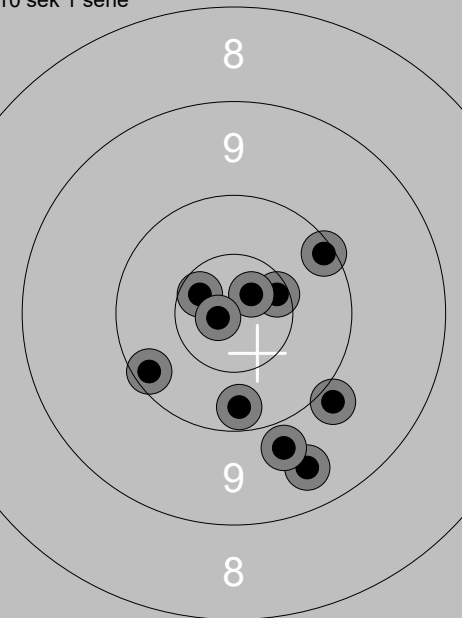
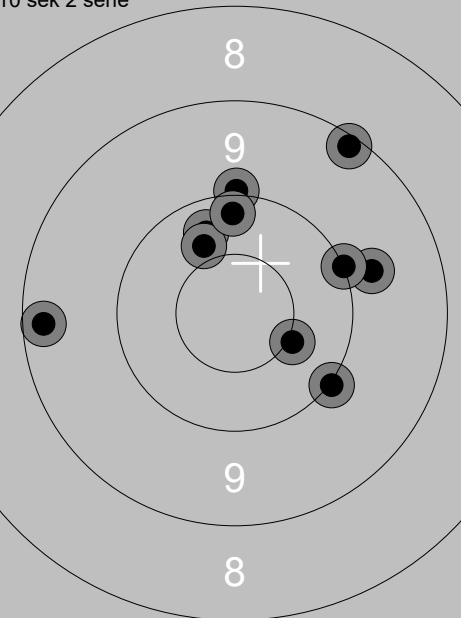
<p>10 sek 1 serie</p> 	<p>2.50s 10.2 ↓ 4.21s 10.6x → 5.63s 10.1 ↗ 7.07s 10.2 ↙ 8.31s 9.5 ↓ 2.54s 10.8x ↗ 4.18s 10.6x ↙ 5.15s 9.8 ↓ 6.20s 9.9 ↘ 7.29s 10.8x ←</p> <p>Serie 97 ( 4x) Total 97 ( 4x)</p>	<p>10 sek 2 serie</p> 	<p>2.91s 10.3 ↗ 3.97s 10.4 ↗ 5.18s 9.2 ↗ 6.51s 9.8 → 7.67s 10.0 ↑ 2.50s 10.2 ↑ 3.56s 9.3 ← 4.63s 10.0 → 6.22s 10.5x → 7.55s 10.0 ↘</p> <p>Serie 97 ( 1x) Total 194 ( 5x)</p>
--	--	--	--

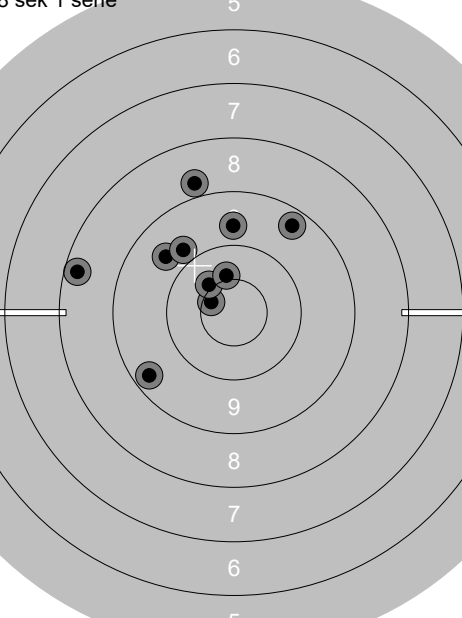
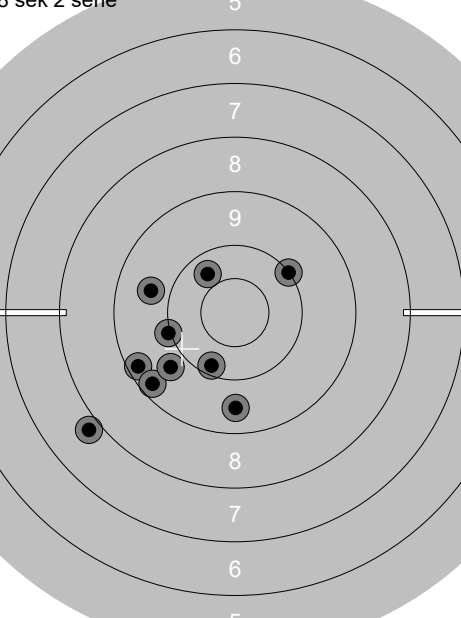
<p>8 sek 1 serie</p> 	<p>2.04s 8.3 ← 3.29s 8.8 ↑ 4.33s 9.4 ↙ 5.64s 10.6x ↙ 6.72s 10.4x ↗ 2.31s 9.7 ↑ 3.89s 9.7 ↙ 4.95s 9.4 ↗ 6.44s 9.8 ↗ 7.46s 10.4x ↑</p> <p>Serie 91 ( 3x) Total 285 ( 8x)</p>	<p>8 sek 2 serie</p> 	<p>2.66s 9.3 ← 3.36s 10.0 ↗ 4.38s 9.7 ← 5.38s 10.3 ↗ 6.54s 7.8 ↙ 2.25s 9.3 ↙ 3.70s 9.6 ↓ 4.76s 10.2 ↘ 6.11s 10.0 ← 7.12s 9.8 ↙</p> <p>Serie 92 ( 0x) Total 377 ( 8x)</p>
--	--	--	--

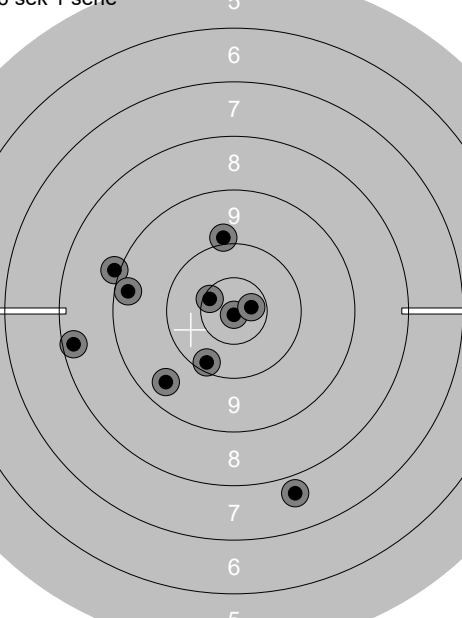
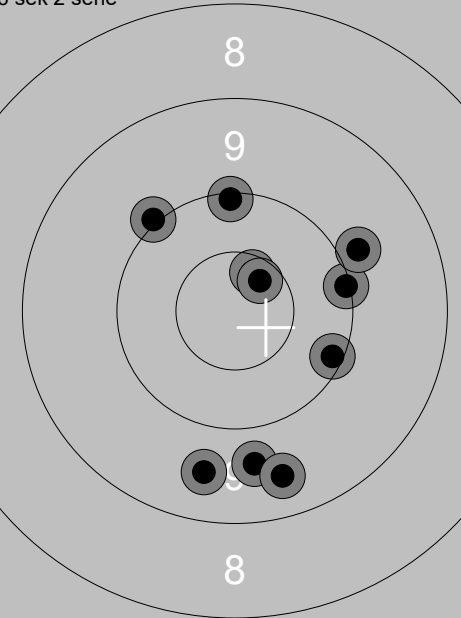
<p>6 sek 1 serie</p> 	<p>1.86s 9.9 ↑ 2.71s 8.3 ← 3.49s 10.9x ↓ 4.45s 7.7 ↓ 5.34s 10.6x ↙ 1.99s 9.0 ← 2.87s 9.3 ← 3.63s 10.7x → 4.47s 9.5 ↙ 6.07s 10.2 ↘</p> <p>Serie 91 ( 3x) Total 468 (11x)</p>	<p>6 sek 2 serie</p> 	<p>2.09s 10.1 → 2.90s 10.1 → 3.81s 9.6 ↓ 4.63s 10.1 ↑ 5.62s 9.7 ↓ 1.94s 10.6x ↗ 3.09s 9.9 → 4.01s 10.6x ↗ 4.94s 10.0 ↗ 5.77s 9.5 ↓</p> <p>Serie 96 ( 2x) Total 564 (13x)</p>
---	---	---	--

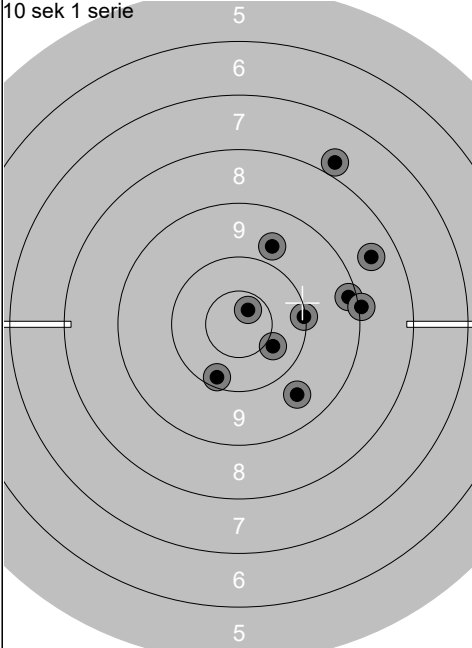
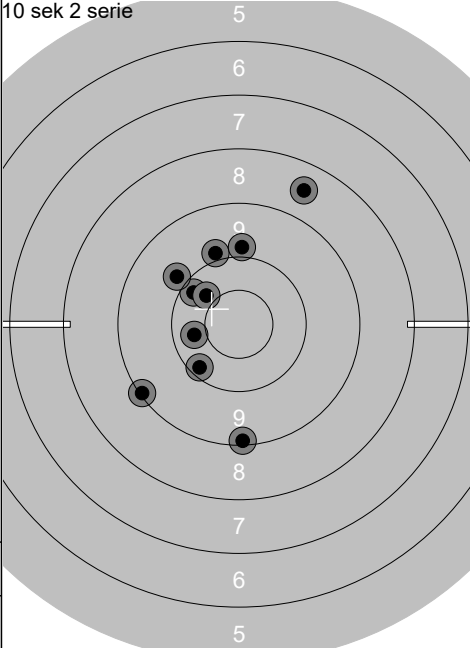
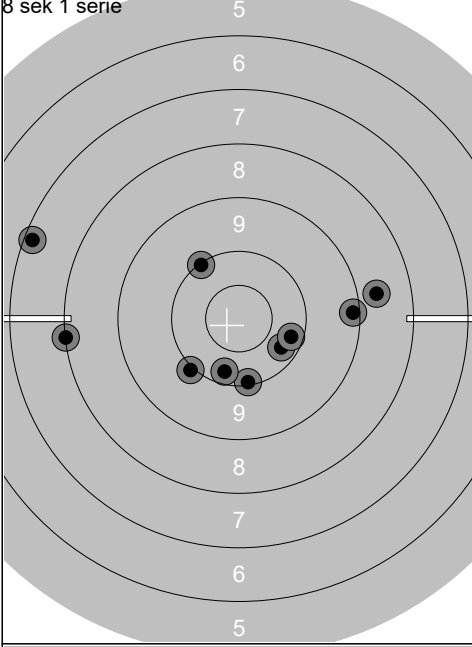
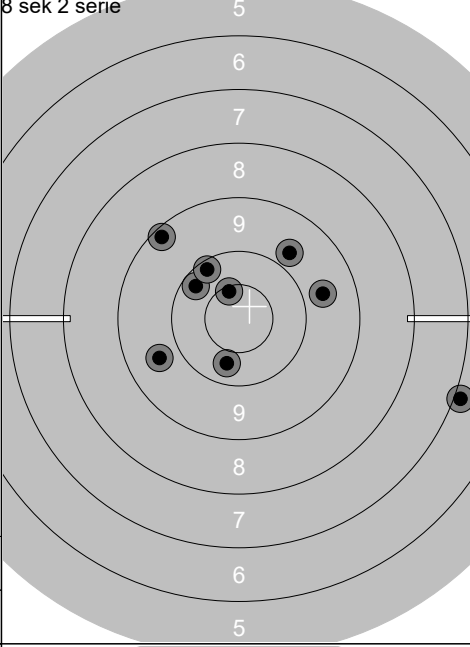
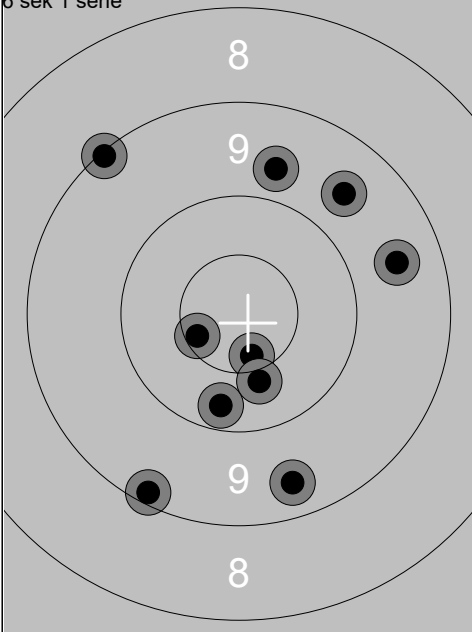
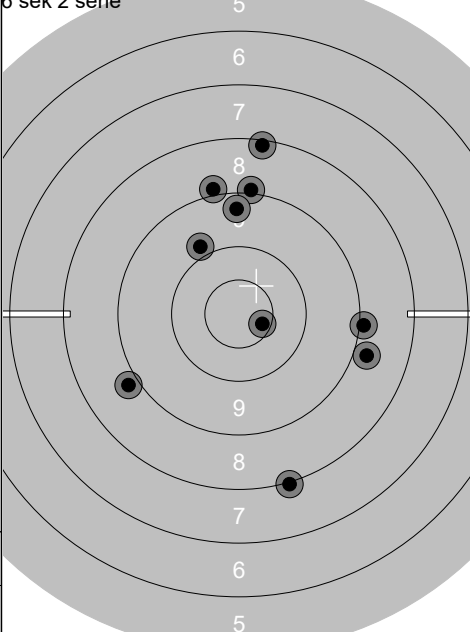
Lag	Skive	Kjetil Hansen			
1	34	Hafersfjord Pk		A	
25.06.2019		NM bane 2019		NM Pistol 2019	
10 sek 1 serie		10 sek 2 serie			
	2.70s 10.2 ↘ 3.61s 10.7x ↗ 4.63s 9.7 ↗ 5.73s 9.2 → 7.02s 8.6 → 2.19s 10.1 → 3.39s 9.0 → 4.38s 7.8 ↗ 5.38s 9.6 ↘ 6.80s 10.4 ↘		2.97s 8.6 ↗ 4.05s 10.2 ↘ 5.22s 9.2 ↓ 6.47s 9.1 ↙ 7.84s 10.2 ↖ 2.66s 10.3 ← 3.67s 10.4 ↖ 4.72s 9.9 ↗ 5.75s 9.9 ↑ 7.07s 9.9 ↖	Serie	91 ( 1x)
Total		Total		Serie	93 ( 0x)
8 sek 1 serie		8 sek 2 serie			
	2.50s 10.1 ↖ 3.38s 7.2 ← 4.49s 10.1 ↓ 5.43s 10.3 ↘ 6.72s 10.2 ↓ 2.76s 9.2 → 4.01s 8.7 → 5.01s 8.1 ← 5.92s 10.0 ↙ 6.82s 10.2 →		2.50s 9.7 ← 3.82s 10.2 ↖ 5.05s 10.2 ↗ 6.15s 9.8 ↗ 7.99s 10.3 ↓ 4.30s 9.2 ↖ 5.57s 10.6x ↗ 6.66s 9.7 → 7.58s 6.9 → --	Serie	92 ( 0x)
Total		Total		Serie	82 ( 1x)
6 sek 1 serie		6 sek 2 serie			
	2.35s 9.4 ↓ 3.20s 10.6x ↘ 3.90s 10.2 ↓ 4.73s 10.6x ↙ 5.50s 9.1 ↖ 1.92s 9.2 ↓ 2.86s 10.4 ↓ 3.75s 9.7 ↗ 4.58s 9.6 ↗ 5.55s 9.6 →		2.29s 9.9 ↖ 3.20s 8.2 ↑ 4.04s 9.0 ↑ 4.87s 9.0 ↑ 5.91s 8.9 ↙ 2.37s 9.4 ↑ 3.18s 8.8 → 4.12s 9.0 → 5.04s 10.6x → 6.01s 8.0 ↓	Serie	94 ( 2x)
Total		Total		Serie	87 ( 1x)
Total		Total		Serie	539 ( 5x)

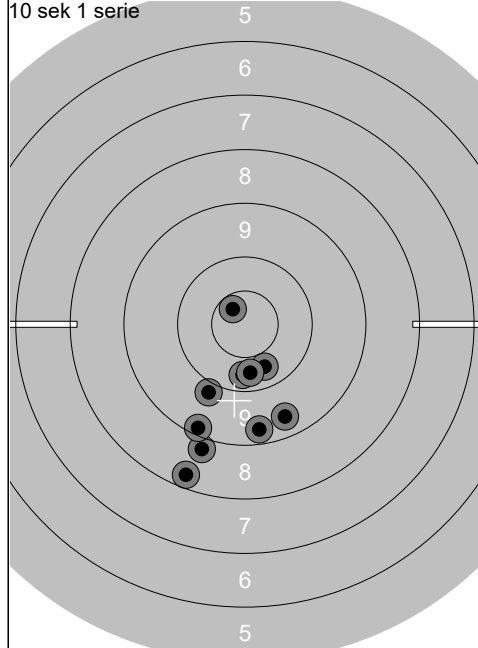

2.85s	8.9	↘
4.18s	10.3	↓
5.47s	10.7x	↗
6.83s	10.3	↓
8.51s	9.4	↓
2.78s	10.3	↓
4.04s	9.2	↓
5.27s	9.9	↓
6.56s	8.3	↓
7.87s	9.5	↓
<b>Serie</b>	<b>92 ( 1x)</b>	
<b>Total</b>	<b>92 ( 1x)</b>	

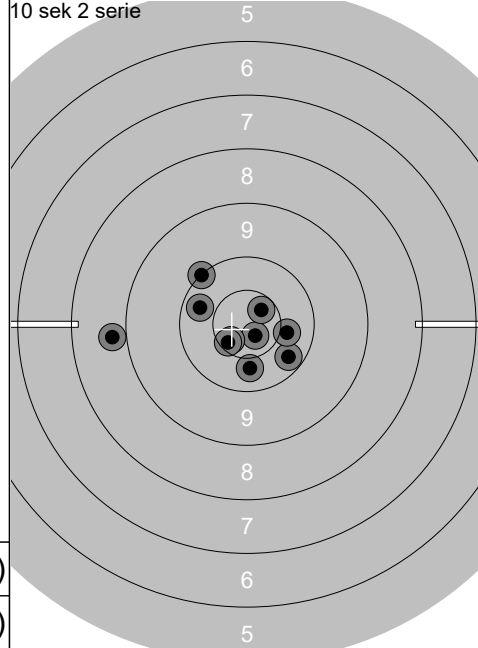

2.69s	10.2	↘
3.95s	10.0	↖
5.17s	10.3	←
6.57s	10.8x	↘
7.95s	10.6x	↙
2.52s	10.4	→
3.73s	10.7x	↗
4.99s	8.8	←
6.10s	10.4	↓
7.40s	10.6x	↙
<b>Serie</b>	<b>98 ( 4x)</b>	
<b>Total</b>	<b>190 ( 5x)</b>	

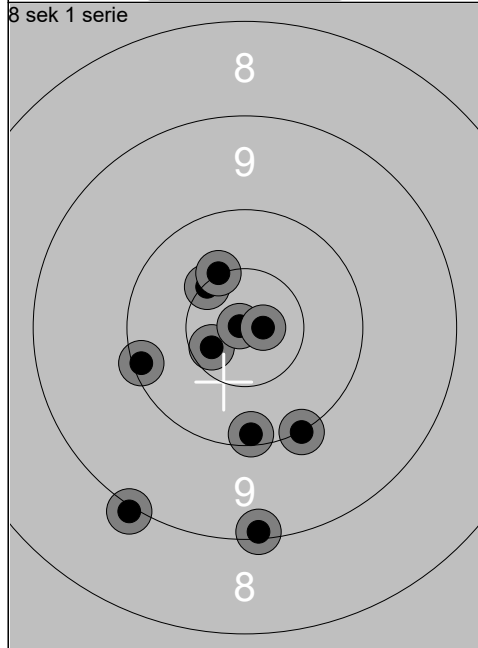

2.37s	10.0	↘
3.51s	10.7x	↙
4.61s	9.0	↘
5.66s	10.1	←
7.01s	9.1	↓
2.37s	10.1	↓
3.35s	10.9x	↙
4.55s	10.8x	→
5.71s	10.5x	↖
6.77s	10.5x	↖
<b>Serie</b>	<b>98 ( 5x)</b>	
<b>Total</b>	<b>288 (10x)</b>	

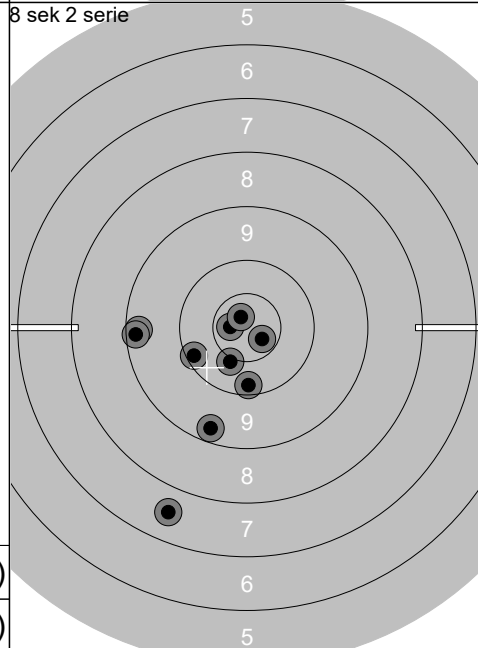

2.50s	10.2	↓
3.58s	9.3	←
4.74s	10.7x	↙
5.77s	10.4x	↘
6.83s	9.3	←
2.43s	7.6	↓
3.36s	9.3	↓
4.34s	10.1	←
5.27s	10.8x	↖
6.24s	10.7x	↘
<b>Serie</b>	<b>94 ( 4x)</b>	
<b>Total</b>	<b>382 (14x)</b>	

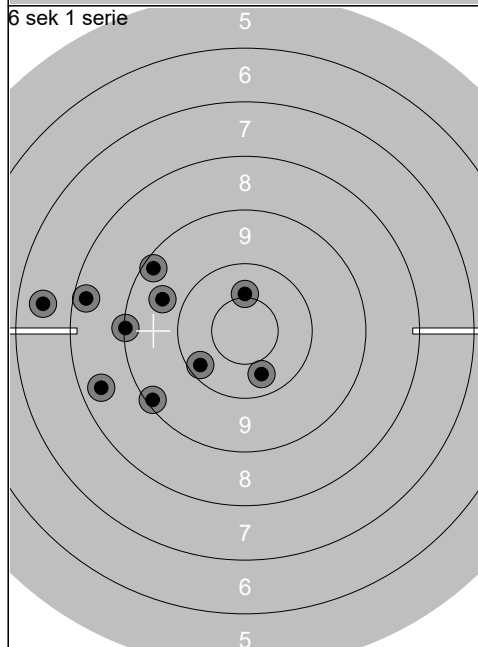

2.24s	10.3	↓
3.13s	9.1	←
3.97s	9.7	↖
4.76s	10.2	↘
5.63s	7.5	←
2.24s	9.3	↖
3.01s	9.2	↘
4.04s	8.4	←
4.88s	10.4x	↑
5.81s	8.3	←
<b>Serie</b>	<b>89 ( 1x)</b>	
<b>Total</b>	<b>471 (15x)</b>	

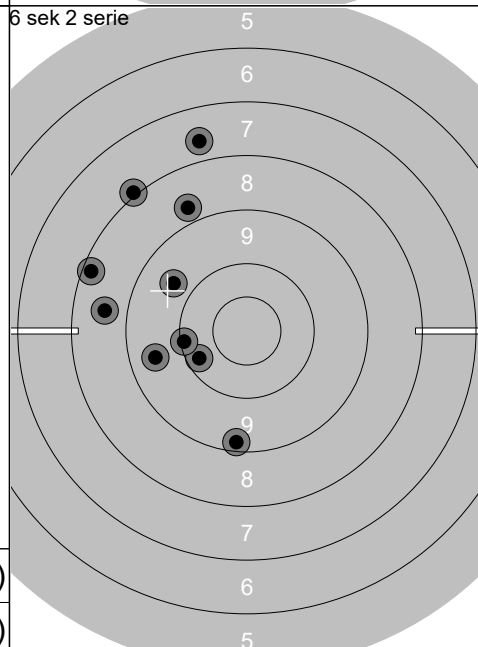

2.12s	10.2	↙
3.05s	8.7	←
3.95s	10.1	←
4.75s	9.7	↖
5.56s	9.6	←
2.02s	9.3	↓
3.57s	8.2	←
4.19s	8.0	↖
4.80s	8.8	↖
5.58s	7.7	↑
<b>Serie</b>	<b>86 ( 0x)</b>	
<b>Total</b>	<b>557 (15x)</b>	

Lag	Skive	Pål Hembre	
Hurtigpistol Grov	Bærum PK	A	
25.06.2019	NM bane 2019	NM Pistol 2019	
10 sek 1 serie	2.79s 10.6x ← 4.33s 10.4 ← 5.74s 10.1 ↘ 6.98s 9.7 → 8.46s 10.5x ↗ 2.83s 10.5x ← 4.28s 10.2 ← 5.59s 9.6 ← 7.09s 10.5x ← 8.60s 10.6x ↓ Serie 98 ( 5x) Total 98 ( 5x)	10 sek 2 serie	2.73s 10.6x ↘ 4.22s 10.7x ↖ 6.23s 10.7x ← 7.73s 10.1 ↗ 9.24s 9.9 ↓ 2.84s 10.7x → 4.16s 10.4 ↗ 5.51s 10.4 ← 6.78s 10.5x ↓ 7.96s 10.0 ↓ Serie 99 ( 5x) Total 197 ( 10x)
8 sek 1 serie	2.19s 10.4 ↗ 3.34s 10.6x → 4.36s 9.9 ↗ 5.54s 10.3 ← 6.62s 10.6x ↖ 2.31s 10.5x ← 3.45s 10.3 ↘ 4.59s 10.2 ↘ 5.62s 9.7 ↗ 6.55s 10.5x → Serie 98 ( 4x) Total 295 ( 14x)	8 sek 2 serie	2.52s 10.3 ↓ 3.64s 10.3 ↖ 4.62s 10.4 ↓ 5.65s 10.4 ↖ 6.68s 10.0 ← 2.27s 9.9 ↘ 3.46s 10.1 ← 4.44s 10.4 ↗ 5.42s 10.0 ↗ 6.52s 9.9 ↓ Serie 98 ( 0x) Total 393 ( 14x)
6 sek 1 serie	1.91s 10.1 ← 2.82s 8.9 → 3.61s 10.2 ↘ 4.49s 10.3 ← 5.28s 9.5 ↗ 2.04s 9.8 ← 2.97s 10.8x ↗ 3.93s 10.8x ↘ 4.74s 10.8x ↗ 5.61s 10.4x → Serie 96 ( 4x) Total 489 ( 18x)	6 sek 2 serie	2.11s 10.2 ↘ 2.96s 10.4 ↗ 3.88s 9.7 ↘ 4.76s 9.3 ↘ 5.58s 9.6 → 1.88s 9.4 ← 2.80s 10.4x ← 3.70s 9.8 ← 4.61s 10.9x → 5.47s 9.3 → Serie 94 ( 2x) Total 583 ( 20x)



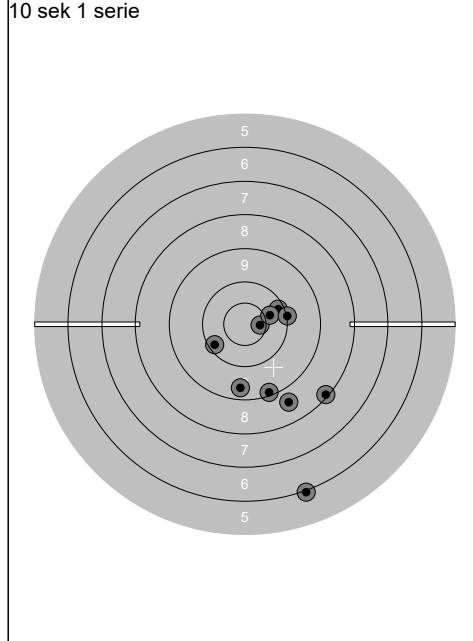

3.18s	10.2	➔
4.55s	10.6x	➔
5.70s	10.4	➔
6.91s	9.4	↓
7.96s	10.0	➔
2.82s	6.0	↓
4.28s	8.7	↓
5.46s	8.1	↓
6.36s	10.2	↙
7.28s	9.2	↓
<b>Serie</b>	<b>90</b>	<b>( 1x)</b>
<b>Total</b>	<b>90</b>	<b>( 1x)</b>

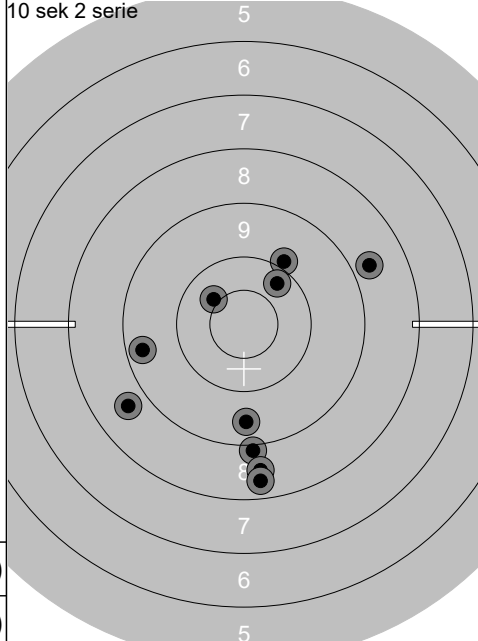

3.06s	9.9	↗
4.07s	9.5	↓
5.27s	8.7	➔
6.37s	9.4	↙
7.46s	10.4x	↖
2.88s	9.0	↓
4.09s	10.2	↗
5.28s	8.6	↓
6.36s	8.7	↙
7.56s	8.4	↓
<b>Serie</b>	<b>88</b>	<b>( 1x)</b>
<b>Total</b>	<b>178</b>	<b>( 2x)</b>

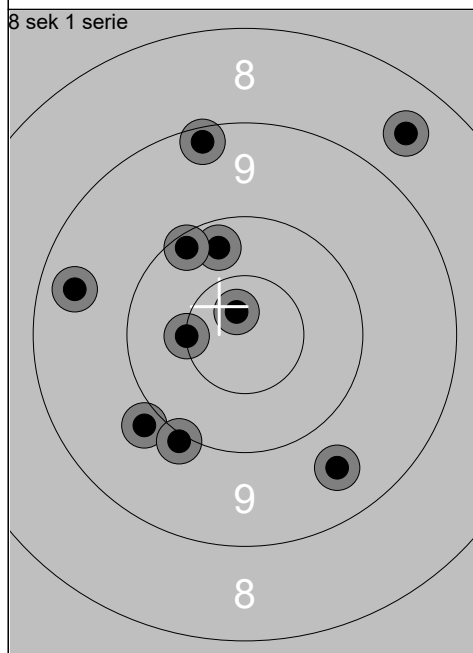

2.75s	8.6	↗
3.68s	9.2	↑
4.65s	9.5	↙
5.55s	10.2	↑
6.63s	10.1	↗
2.48s	9.9	↙
3.44s	10.8x	↗
4.50s	9.6	↓
5.53s	10.5x	↙
6.59s	10.0	↓
<b>Serie</b>	<b>94</b>	<b>( 2x)</b>
<b>Total</b>	<b>272</b>	<b>( 4x)</b>

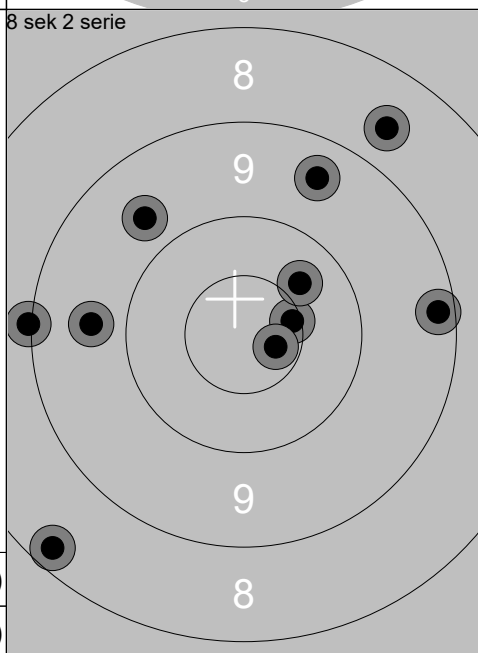

2.47s	10.6x	➔
3.51s	9.7	↙
4.49s	9.5	↑
5.49s	9.7	↖
6.63s	9.2	➔
2.42s	8.7	↗
3.97s	8.3	↙
4.92s	10.4	↗
5.57s	9.0	↙
6.21s	10.7x	➔
<b>Serie</b>	<b>91</b>	<b>( 2x)</b>
<b>Total</b>	<b>363</b>	<b>( 6x)</b>

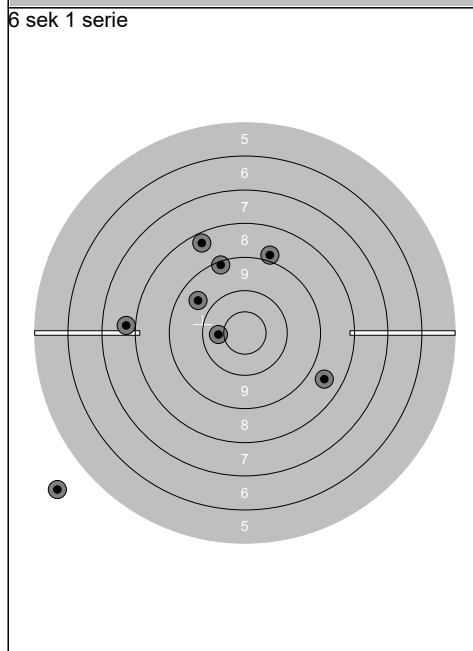

4.03s	9.2	↑
4.63s	7.8	↙
4.91s		☒
5.37s		☒
5.60s	0.0	↙
2.04s	9.6	↖
2.90s	8.9	↑
3.86s	8.3	↗
4.71s	8.6	↘
5.47s	10.4	↙
<b>Serie</b>	<b>59</b>	<b>( 0x)</b>
<b>Total</b>	<b>422</b>	<b>( 6x)</b>

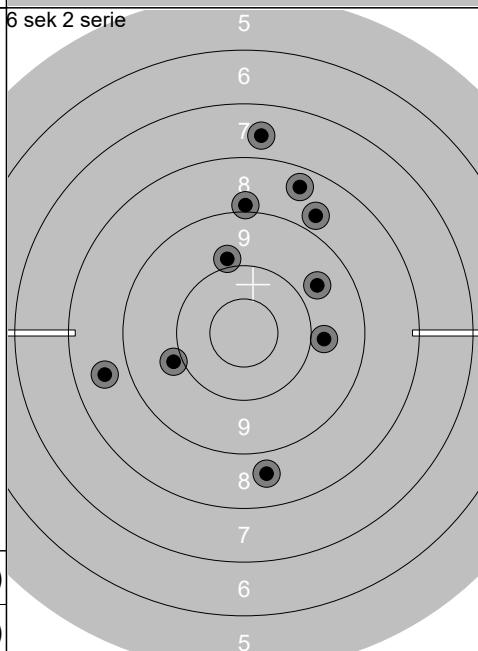

2.10s	8.9	↑
2.87s	9.7	↗
3.62s	9.8	➔
4.38s	9.9	↑
5.16s	8.4	↗
2.02s	7.6	↑
3.18s	8.6	↙
4.07s	9.9	↙
4.90s	8.7	↓
5.66s	8.8	↗
<b>Serie</b>	<b>83</b>	<b>( 0x)</b>
<b>Total</b>	<b>505</b>	<b>( 6x)</b>

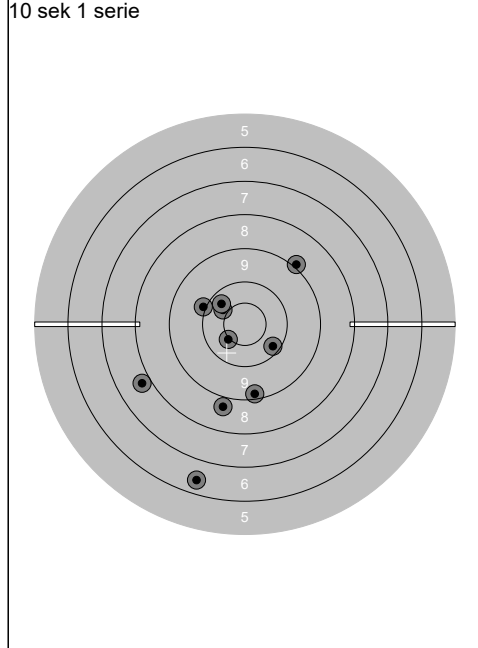

3.21s	10.4	↖
4.67s	8.8	↓
5.97s	10.5x	↙
7.38s	10.3	↖
8.83s	7.8	↙
3.02s	9.2	↓
4.54s	9.0	↗
5.82s	6.5	↓
7.28s	10.2	↘
8.73s	10.0	↖
<b>Serie</b>	<b>89 ( 1x)</b>	
<b>Total</b>	<b>89 ( 1x)</b>	

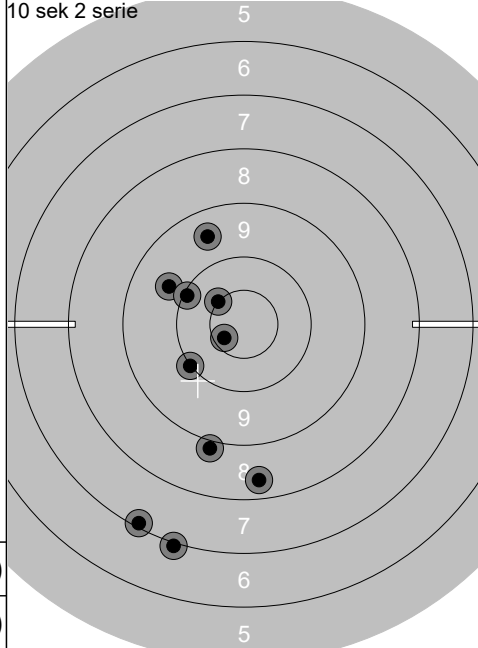

2.82s	9.8	↖
4.37s	10.1	↖
5.70s	10.0	↙
7.05s	8.4	↓
8.51s	7.2	↓
2.80s	9.6	↗
4.30s	10.5x	↖
5.78s	8.9	↓
7.19s	7.0	↓
8.55s	10.6x	↙
<b>Serie</b>	<b>88 ( 2x)</b>	
<b>Total</b>	<b>177 ( 3x)</b>	

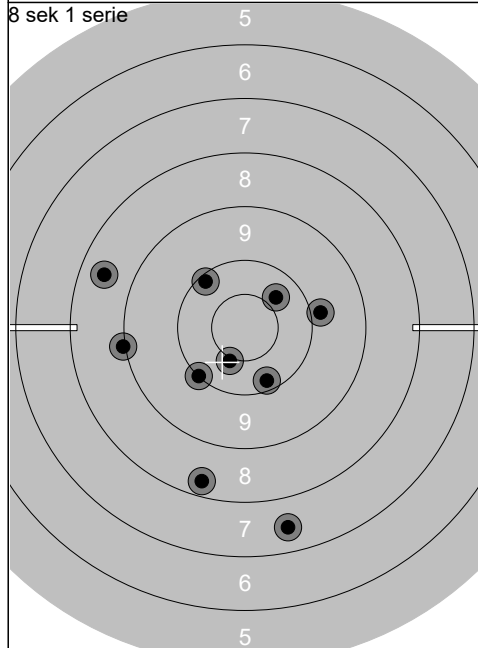

2.18s	8.5	↖
3.30s	10.0	↙
4.20s	10.2	↓
5.30s	10.4	↗
6.29s	9.0	↖
2.41s	8.4	↓
3.53s	10.1	↖
4.46s	7.5	↓
5.62s	10.5x	↙
6.69s	9.9	→
<b>Serie</b>	<b>91 ( 1x)</b>	
<b>Total</b>	<b>268 ( 4x)</b>	

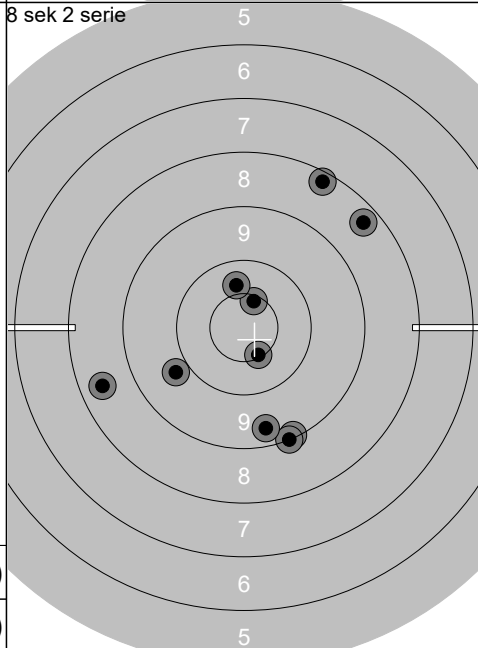

2.43s	10.5x	↙
3.71s	8.5	↖
4.69s	8.3	↗
5.77s	9.1	↓
6.86s	10.6x	↗
2.50s	9.1	↓
3.61s	9.8	↖
4.76s	8.4	↗
5.84s	9.4	↓
6.95s	10.4	↗
<b>Serie</b>	<b>90 ( 2x)</b>	
<b>Total</b>	<b>358 ( 6x)</b>	

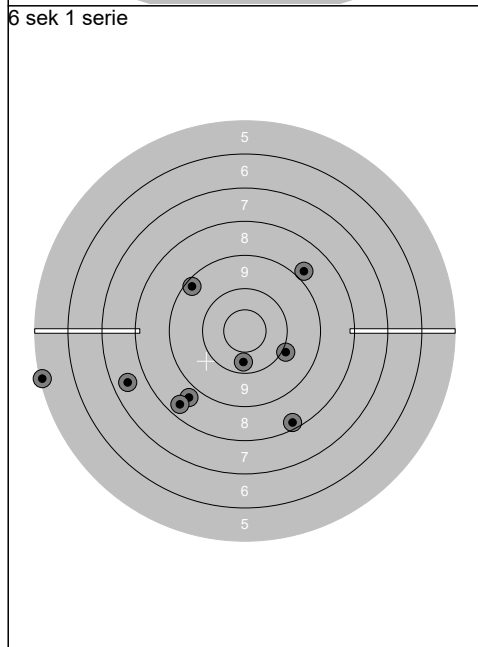

1.83s	5.1	↖
2.70s	8.8	↗
3.49s	8.3	↓
4.34s	10.0	↘
5.12s	8.7	↙
2.02s		↖
2.97s	10.3	↓
3.85s	8.4	↙
4.76s	9.3	↖
5.68s	7.5	↖
<b>Serie</b>	<b>73 ( 0x)</b>	
<b>Total</b>	<b>431 ( 6x)</b>	

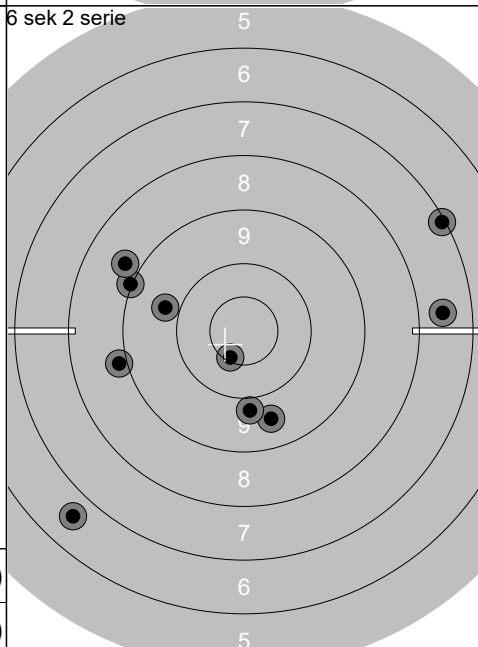

1.97s	9.0	↖
2.95s	6.6	↙
3.87s	7.6	→
4.78s	7.1	↗
5.71s	8.8	↖
2.08s	9.8	↖
3.05s	10.5x	↙
3.99s	9.6	↓
4.94s	9.8	↓
5.83s	8.9	↖
<b>Serie</b>	<b>82 ( 1x)</b>	
<b>Total</b>	<b>513 ( 7x)</b>	

<p>10 sek 1 serie</p>	<p>2.77s 10.6x ↙ 4.15s 9.9 ← 5.54s 10.1 ← 6.94s 10.7x → 8.69s 10.2 ↓ 2.96s 10.2 ↓ 4.38s 9.6 ← 5.93s 9.6 ← 7.44s 10.5x ↙ 8.82s 10.6x ↓</p> <p>Serie 97 ( 4x) Total 97 ( 4x)</p>	<p>10 sek 2 serie</p>	<p>2.87s 10.4x ↓ 4.08s 10.4 ↑ 5.39s 10.8x ↑ 6.63s 9.9 ← 8.27s 10.3 ↘ 3.14s 10.4 ↓ 4.45s 10.1 → 5.74s 10.4x ↑ 6.97s 10.2 ↖ 8.06s 10.0 ↖</p> <p>Serie 99 ( 3x) Total 196 ( 7x)</p>
-----------------------	--	-----------------------	--

<p>8 sek 1 serie</p>	<p>2.95s 10.0 ← 4.08s 10.2 ↖ 5.09s 9.7 ↗ 6.35s 8.5 → 7.54s 10.6x ↑ 2.79s 9.5 ← 4.05s 9.8 ← 5.22s 10.3 ← 6.30s 10.2 ↓ 7.36s 10.2 ↓</p> <p>Serie 95 ( 1x) Total 291 ( 8x)</p>	<p>8 sek 2 serie</p>	<p>2.61s 10.0 ↖ 4.01s 10.2 ← 5.08s 10.4x → 6.11s 10.8x ↓ 7.23s 10.4 ↖ 2.56s 10.4x ↖ 3.71s 10.4 ↖ 4.78s 8.2 ← 6.04s 9.8 ↖ 7.23s 9.6 ↑</p> <p>Serie 96 ( 3x) Total 387 ( 11x)</p>
----------------------	---	----------------------	---

<p>6 sek 1 serie</p>	<p>2.17s 10.2 ← 3.08s 10.4 ← 3.92s 10.0 ↖ 4.79s 10.0 ↖ 5.59s 10.3 ↖ 2.31s 9.9 ↖ 3.14s 10.1 ↗ 4.01s 10.4x ↑ 4.90s 10.7x ↖ 5.74s 10.0 ↑</p> <p>Serie 99 ( 2x) Total 486 ( 13x)</p>	<p>6 sek 2 serie</p>	<p>2.21s 9.4 ↑ 2.99s 9.6 ↖ 3.74s 9.9 → 4.51s 9.7 ↗ 5.29s 8.9 ↓ 2.18s 8.6 ↗ 2.99s 10.1 ↑ 3.82s 9.6 ↗ 4.69s 9.0 ↗ 5.48s 9.1 ↖</p> <p>Serie 89 ( 0x) Total 575 ( 13x)</p>
----------------------	--	----------------------	--

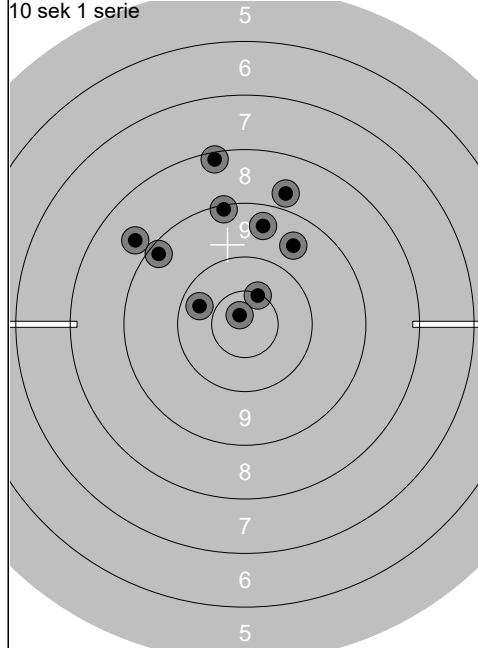

2.62s	9.1	↑
4.08s	9.2	↖
5.65s	10.3	↖
7.18s	10.5x	↗
9.16s	9.6	↗
2.75s	10.8x	↖
4.49s	8.8	↑
6.08s	8.2	↑
7.34s	9.5	↑
8.86s	8.8	↖
<b>Serie</b>	<b>90 ( 2x)</b>	
<b>Total</b>	<b>90 ( 2x)</b>	

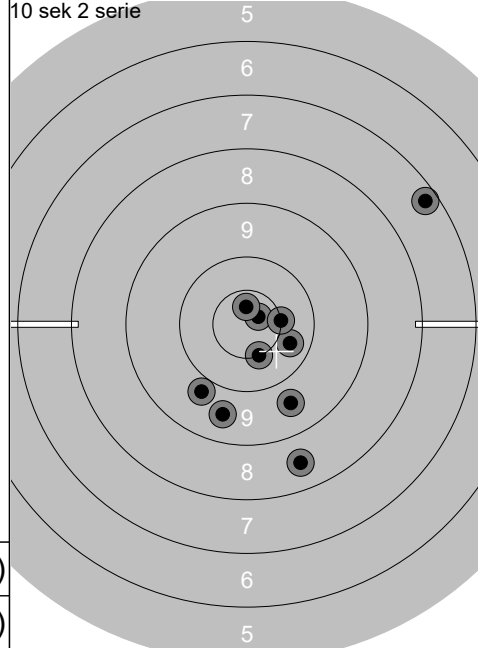

2.69s	10.8x	↗
3.98s	7.3	↗
5.21s	8.6	↓
6.67s	10.3	→
7.98s	9.6	↓
2.62s	9.6	↓
3.93s	10.5x	↓
5.39s	9.8	↖
6.90s	10.7x	↑
8.19s	10.5x	→
<b>Serie</b>	<b>92 ( 4x)</b>	
<b>Total</b>	<b>182 ( 6x)</b>	

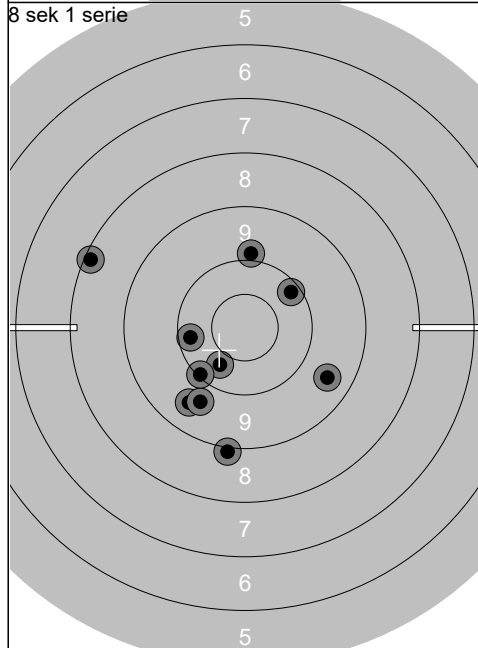

2.20s	9.6	↖
2.98s	9.9	↑
4.16s	9.5	→
5.23s	9.7	↖
6.32s	10.3	↖
2.35s	9.0	↓
3.65s	10.2	↗
4.92s	10.2	←
5.85s	10.1	↖
7.05s	8.2	↖
<b>Serie</b>	<b>93 ( 0x)</b>	
<b>Total</b>	<b>275 ( 6x)</b>	

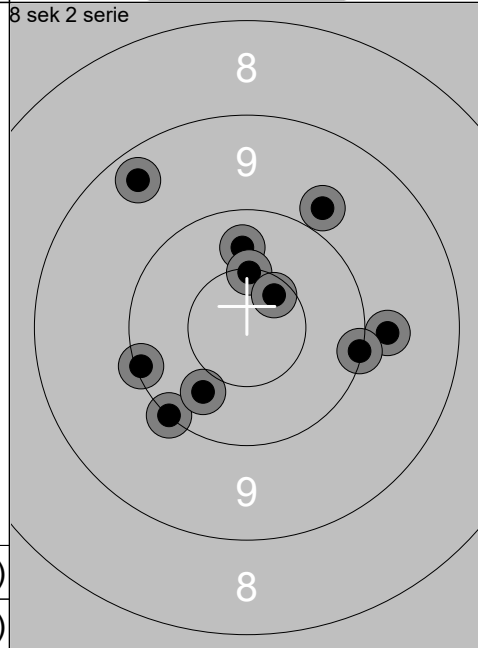

2.40s	9.8	→
4.19s	10.1	→
5.38s	10.0	↖
6.48s	10.3	↖
7.50s	10.1	←
2.31s	10.3	↑
3.24s	10.5x	↑
4.55s	9.4	↖
5.79s	10.6x	↗
7.00s	9.8	↗
<b>Serie</b>	<b>97 ( 2x)</b>	
<b>Total</b>	<b>372 ( 8x)</b>	

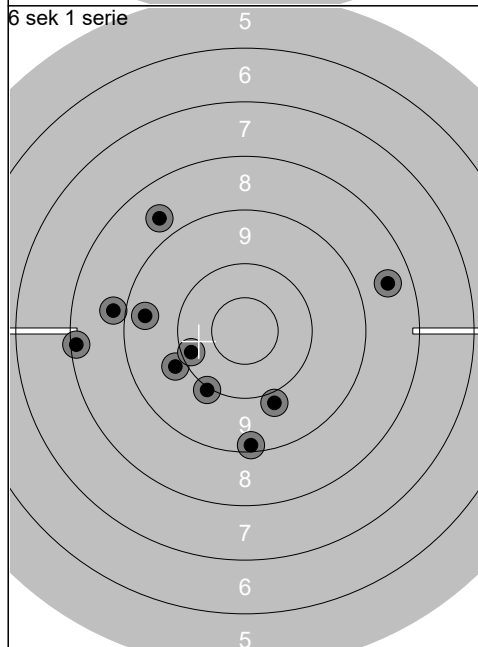

1.92s	9.2	↓
2.85s	9.9	↖
3.56s	8.7	↖
4.29s	8.8	←
5.09s	9.4	←
1.83s	10.2	←
2.61s	10.0	↖
3.48s	8.5	→
4.26s	9.9	↓
5.28s	8.2	←
<b>Serie</b>	<b>88 ( 0x)</b>	
<b>Total</b>	<b>460 ( 8x)</b>	

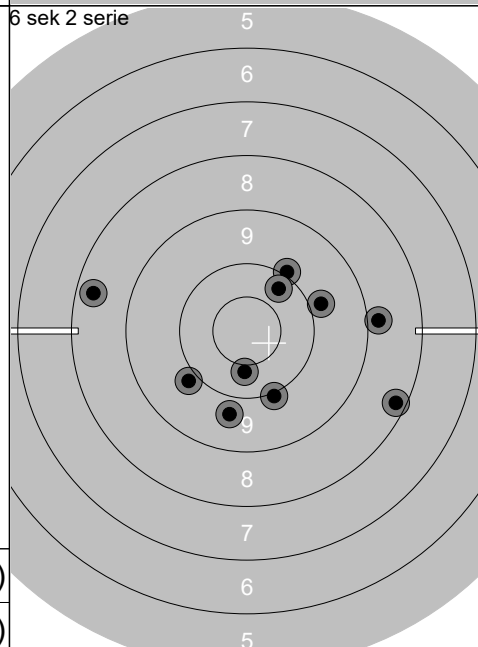

2.41s	10.0	↓
3.23s	10.0	↗
3.84s	8.2	→
4.42s	8.4	←
4.99s	9.9	→
2.04s	10.4	↓
2.97s	9.9	↖
3.75s	10.2	↗
4.40s	9.7	↓
5.23s	8.9	→
<b>Serie</b>	<b>91 ( 0x)</b>	
<b>Total</b>	<b>551 ( 8x)</b>	

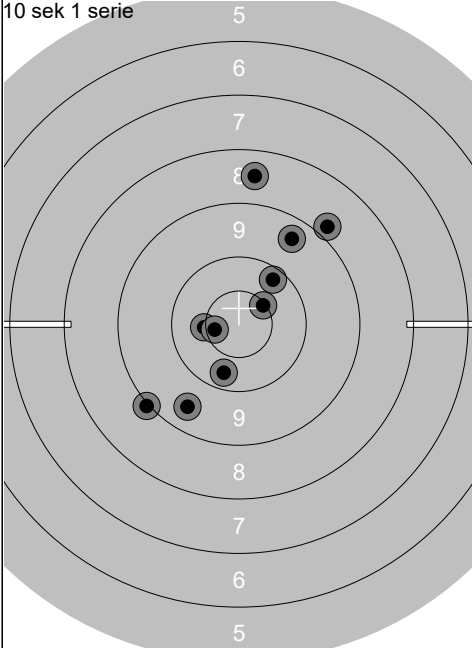
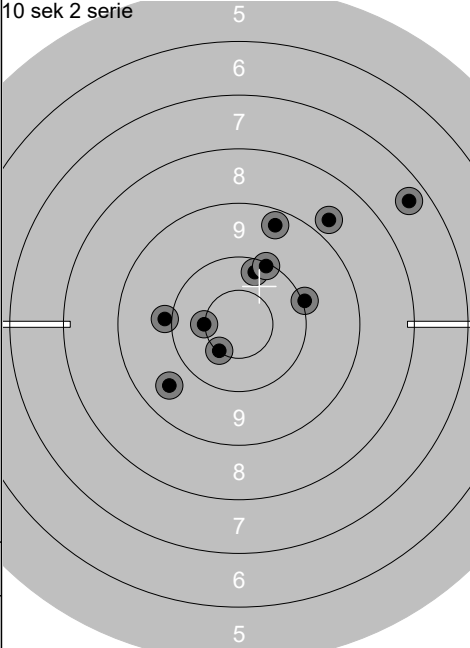
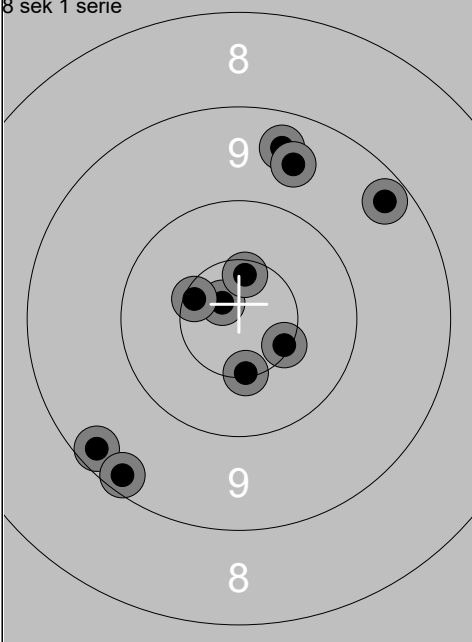
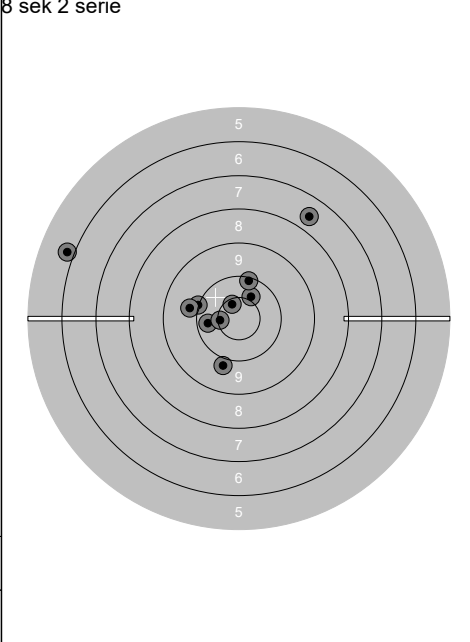
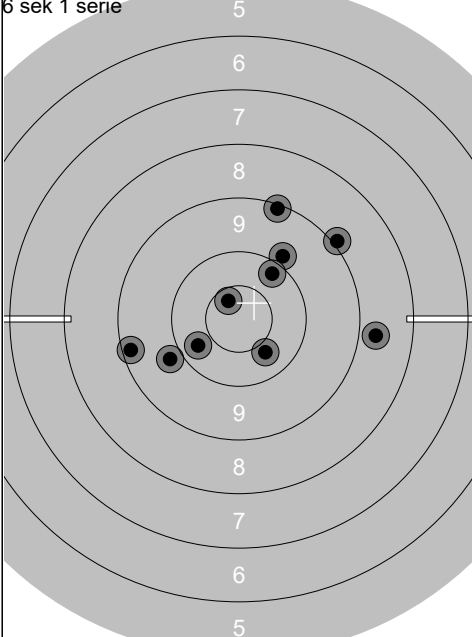
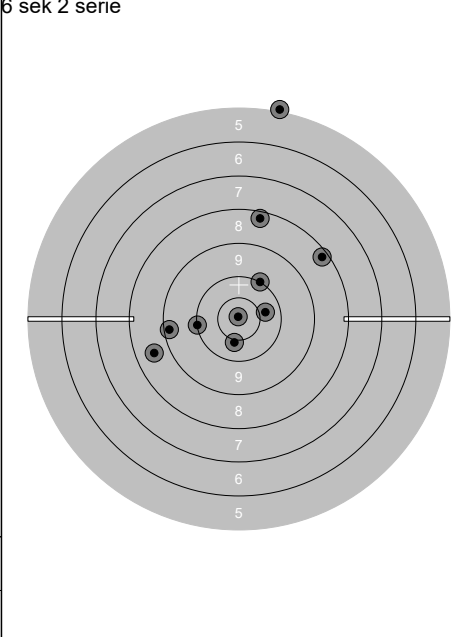
Lag	Skive	Frank Lien				
Hurtigpistol Grov		Ringerike Pk		A		
25.06.2019		NM bane 2019		NM Pistol 2019		
10 sek 1 serie		2.86s 9.0 ↙ 4.21s 10.2 ↗ 5.22s 8.9 ↗ 6.38s 10.5x← 7.75s 9.5 ↘ 3.30s 9.5 ↗ 4.51s 10.3 ↘ 5.30s 10.5x↗ 6.12s 10.6x← 7.47s 8.5 ↑		10 sek 2 serie		2.84s 10.2 ↗ 3.97s 9.4 ↗ 5.21s 8.8 ↗ 6.26s 7.4 ↗ 7.40s 10.0 → 2.58s 9.9 ← 3.56s 10.1 ↗ 4.80s 10.5x↘ 5.89s 10.5x← 6.89s 9.6 ↘
		Serie 93 ( 3x)				Serie 92 ( 2x)
		Total 93 ( 3x)				Total 185 ( 5x)
8 sek 1 serie		2.18s 9.3 ↙ 3.21s 10.8x↘ 4.24s 9.3 ↗ 5.11s 10.5x↘ 6.15s 10.6x↘ 1.92s 9.2 ↘ 3.04s 10.6x↑ 4.01s 9.4 ↑ 4.98s 10.5x↘ 5.95s 9.6 ↗		8 sek 2 serie		2.13s 7.6 ↗ 3.13s 10.4 ↗ 4.11s 10.3 ← 5.08s 9.8 ↘ 5.58s 5.9 ← 2.31s 10.6x↗ 3.34s 10.0 ← 4.30s 9.8 ← 5.32s 10.5x← 6.36s 10.1 ↗
		Serie 95 ( 5x)				Serie 90 ( 2x)
		Total 280 (10x)				Total 370 (12x)
6 sek 1 serie		1.78s 9.9 ↗ 2.47s 9.8 ↙ 3.12s 8.8 → 3.78s 10.2 ↗ 4.71s 10.4 ↘ 2.04s 9.0 ↗ 2.91s 9.2 ← 3.75s 10.3 ↙ 4.36s 9.1 ↗ 5.22s 10.7x↘		6 sek 2 serie		1.20s 5.0 ↑ 2.56s 8.2 ↗ 3.94s 8.3 ↑ 4.63s 10.4x↘ 5.28s 10.9x↗ 2.04s 10.0 ↗ 2.88s 9.2 ← 3.60s 10.0 ← 4.51s 8.6 ← 5.22s 10.4 →
		Serie 93 ( 1x)				Serie 88 ( 2x)
		Total 463 (13x)				Total 551 (15x)

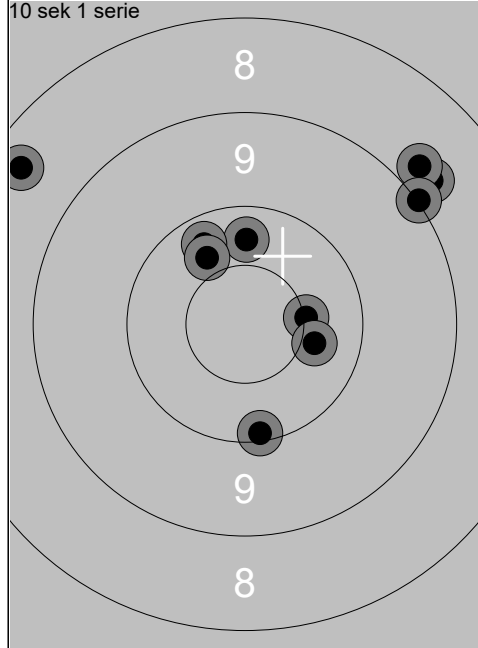

2.74s	8.4	↖
4.34s	8.8	↗
5.64s	10.3	↑
7.07s	10.3	↖
8.66s	10.5x	→
2.50s	10.4	↖
4.09s	8.8	↗
5.21s	10.1	↓
6.80s	10.4	→
8.21s	9.1	↗
<b>Serie</b>	<b>93 ( 1x)</b>	
<b>Total</b>	<b>93 ( 1x)</b>	

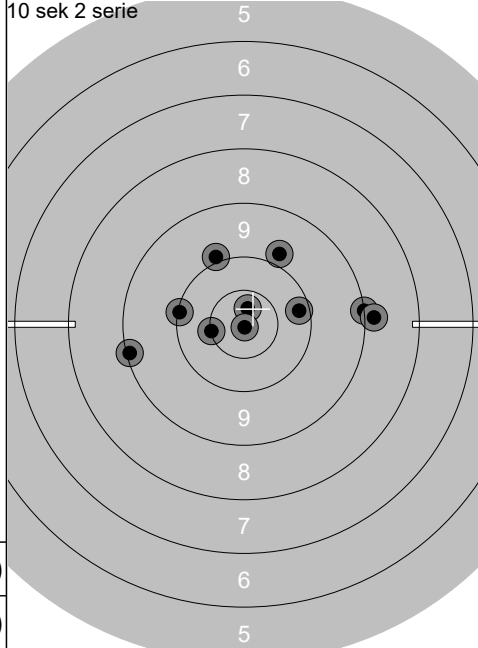

2.52s	10.7x	↗
3.84s	9.1	→
5.05s	10.0	↖
6.25s	10.9x	↓
7.49s	10.5x	←
2.49s	9.1	←
3.79s	10.2	→
4.95s	9.9	↗
6.10s	8.9	→
7.29s	10.1	←
<b>Serie</b>	<b>95 ( 3x)</b>	
<b>Total</b>	<b>188 ( 4x)</b>	

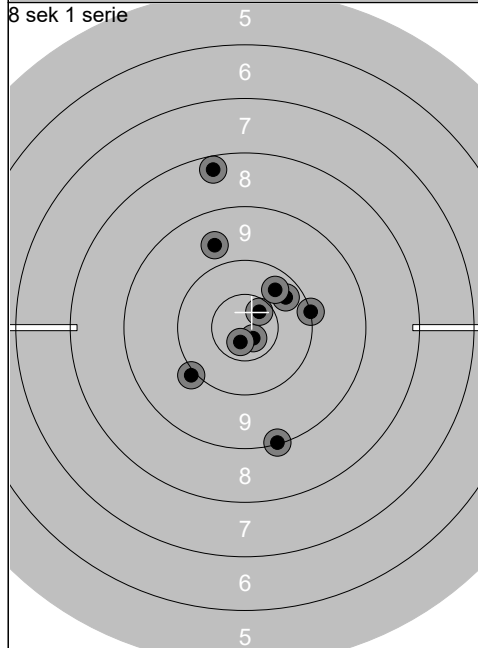

2.31s	10.8x	↘
3.49s	8.3	↑
4.58s	10.7x	↗
5.62s	10.0	↖
6.53s	10.7x	↘
2.50s	9.7	↑
3.61s	10.3	↗
4.71s	10.0	→
5.65s	9.1	↓
6.69s	10.3	↗
<b>Serie</b>	<b>96 ( 3x)</b>	
<b>Total</b>	<b>284 ( 7x)</b>	

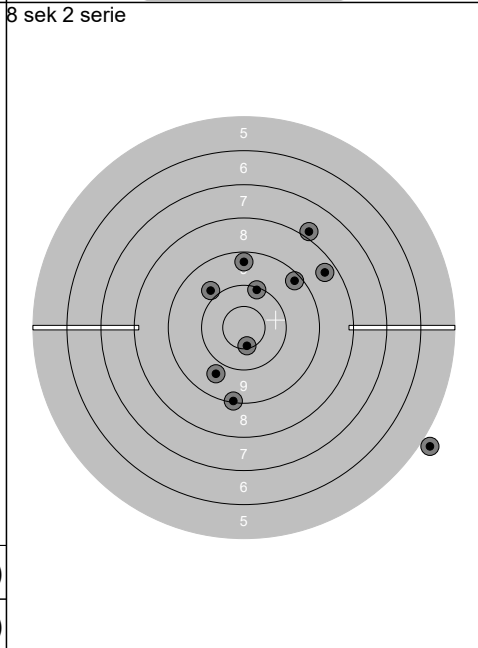

2.38s	9.8	↖
3.55s	9.1	↓
4.66s	8.4	↗
5.75s	10.1	↗
6.89s	9.3	↗
2.42s	7.9	↗
3.60s	9.7	↘
4.80s	0.0	↘
6.26s	10.6x	↘
7.21s	9.4	↑
<b>Serie</b>	<b>80 ( 1x)</b>	
<b>Total</b>	<b>364 ( 8x)</b>	

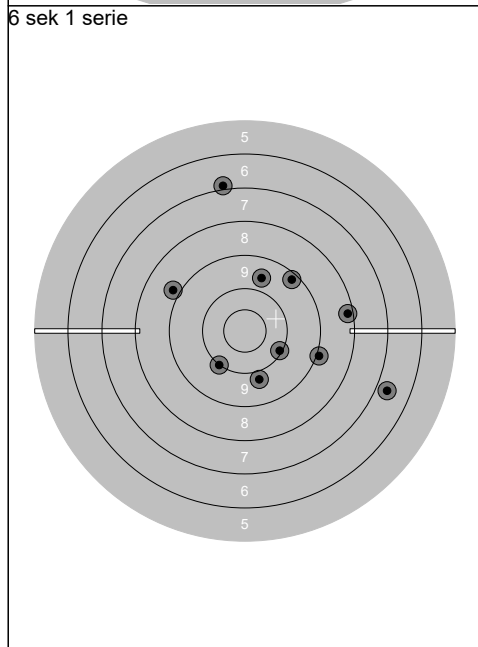

2.19s	8.9	↖
3.12s	10.0	↘
4.07s	9.8	↓
4.84s	9.7	↑
5.69s	6.7	→
2.15s	10.1	↘
3.07s	9.3	↗
4.08s	9.0	→
4.88s	7.0	↑
5.70s	8.2	→
<b>Serie</b>	<b>85 ( 0x)</b>	
<b>Total</b>	<b>449 ( 8x)</b>	

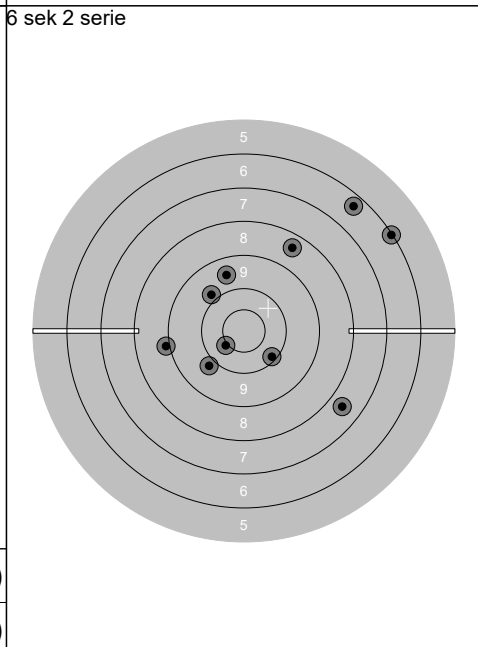

2.19s	10.1	↘
2.97s	9.0	←
3.99s	9.9	↖
4.69s	8.5	↗
5.59s	6.4	↗
2.08s	9.6	↑
2.95s	6.1	↗
3.89s	9.9	↖
4.73s	7.6	↘
5.61s	10.4x	↖
<b>Serie</b>	<b>83 ( 1x)</b>	
<b>Total</b>	<b>532 ( 9x)</b>	

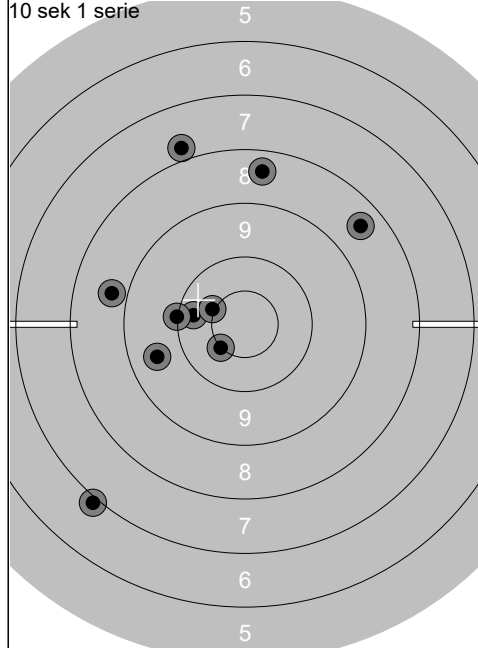

3.59s	7.0	↙
4.80s	10.2	←
6.40s	8.5	↑
7.32s	9.6	←
8.31s	10.5x	↙
2.87s	10.0	←
3.71s	8.8	←
4.54s	10.5x	↙
5.41s	7.8	↑
6.14s	8.5	↗
<b>Serie</b>	<b>87 ( 2x)</b>	
<b>Total</b>	<b>87 ( 2x)</b>	

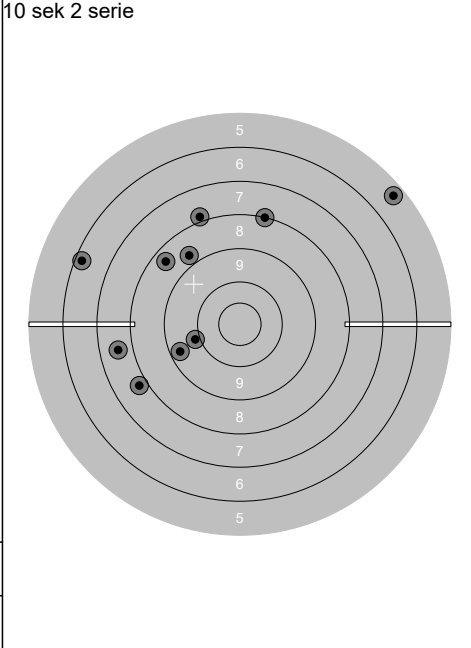

3.19s	5.4	↗
4.08s	8.4	↖
5.21s	9.9	←
6.04s	6.3	←
7.41s	7.9	↑
3.51s	8.8	↖
4.73s	8.1	↑
5.72s	7.8	←
6.65s	9.4	←
7.73s	7.6	←
<b>Serie</b>	<b>74 ( 0x)</b>	
<b>Total</b>	<b>161 ( 2x)</b>	

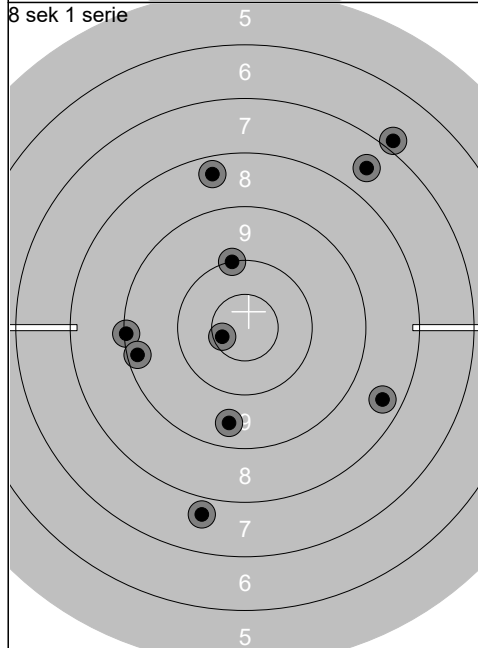

2.68s	6.9	↗
3.77s	10.6x	←
4.92s	9.1	←
5.95s	9.3	←
6.69s	9.5	↓
2.74s	8.4	↑
3.97s	7.8	↓
5.13s	10.0	↑
5.98s	8.4	↘
6.81s	7.6	↗
<b>Serie</b>	<b>83 ( 1x)</b>	
<b>Total</b>	<b>244 ( 3x)</b>	

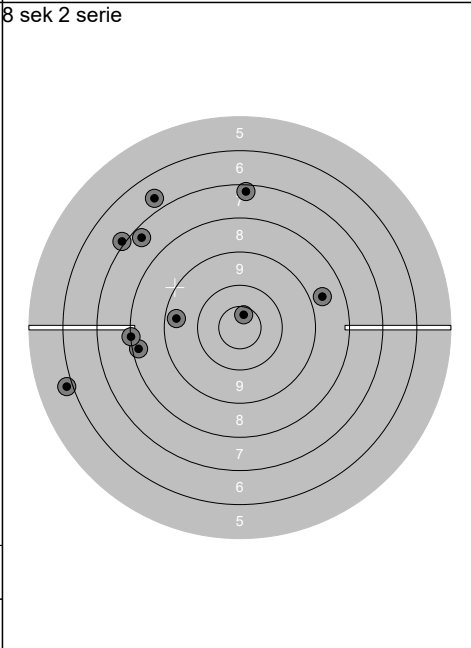

3.47s	8.7	↗
4.29s	8.2	←
5.12s	9.4	←
6.01s	10.7x	↑
6.70s	6.7	↖
2.52s	7.3	↑
4.87s	5.9	←
5.73s	8.1	←
3.65s	7.4	↖
4.46s	7.0	↖
<b>Serie</b>	<b>75 ( 1x)</b>	
<b>Total</b>	<b>319 ( 4x)</b>	

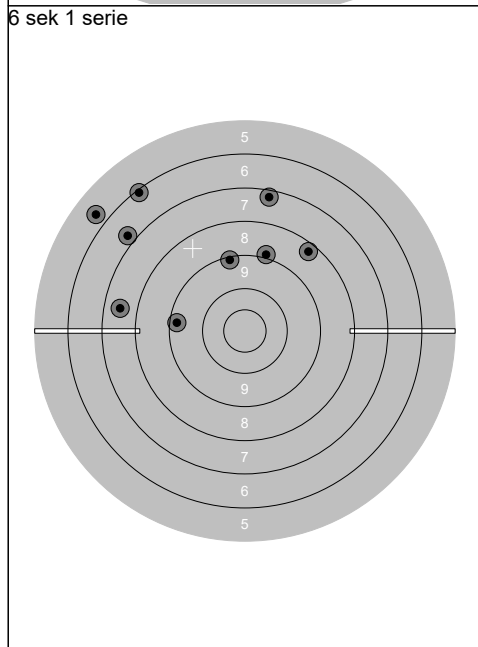

2.25s	7.3	↑
3.03s	6.1	↖
3.67s	8.3	↗
4.48s	9.2	↑
5.27s	9.3	←
2.25s		☒
3.11s	9.0	↑
3.74s	5.7	↖
4.80s	6.8	↖
5.50s	7.6	←
<b>Serie</b>	<b>66 ( 0x)</b>	
<b>Total</b>	<b>385 ( 4x)</b>	

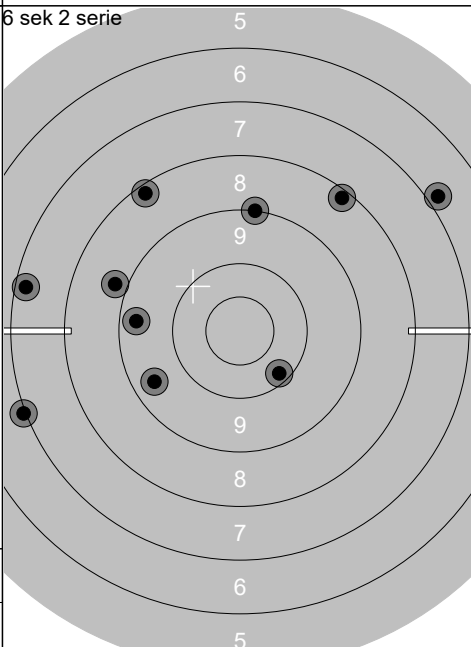

2.09s	6.9	↗
3.00s	8.2	↗
3.67s	7.3	←
4.33s	8.9	←
5.26s	9.4	←
2.27s	9.1	↑
3.13s	9.5	←
4.04s	8.2	↖
4.98s	10.2	↘
5.67s	7.0	←
<b>Serie</b>	<b>81 ( 0x)</b>	
<b>Total</b>	<b>466 ( 4x)</b>	

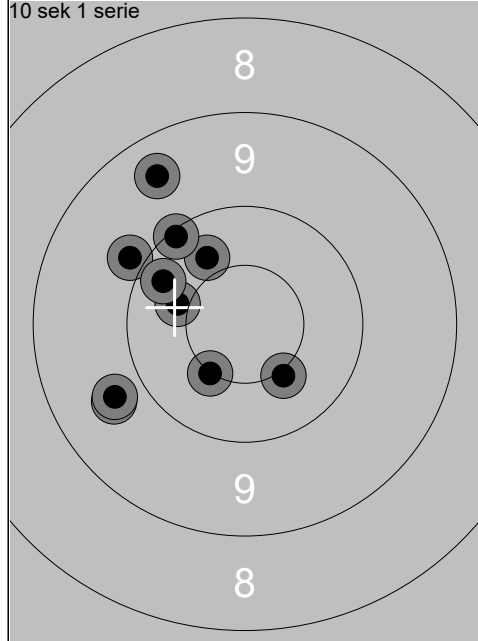

2.80s	9.5	↗
4.07s	10.4	↖
5.37s	10.4	↗
6.62s	9.7	↖
7.76s	9.7	↖
2.97s	10.5x	↘
4.13s	9.9	↖
5.38s	10.2	↖
6.70s	10.5x	↘
8.03s	10.1	↗
<b>Serie</b>	<b>96 ( 2x)</b>	
<b>Total</b>	<b>96 ( 2x)</b>	

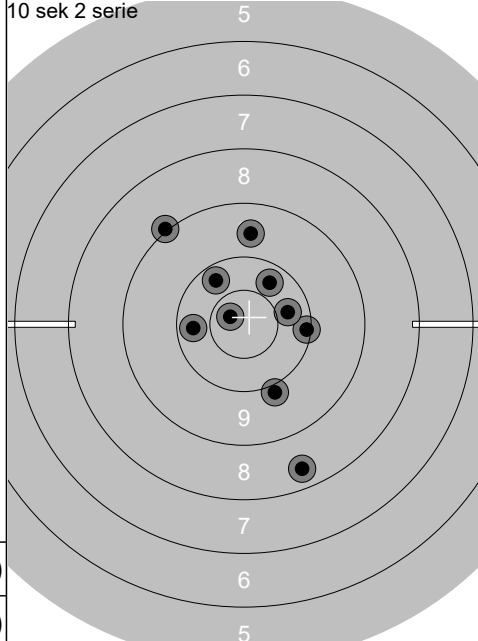

2.82s	8.4	↘
4.03s	10.1	→
5.18s	9.6	↑
6.52s	10.3	↖
7.64s	10.2	↗
2.81s	9.9	↘
3.86s	9.0	↗
5.11s	10.3	→
6.30s	10.7x	↖
7.67s	10.3	↗
<b>Serie</b>	<b>95 ( 1x)</b>	
<b>Total</b>	<b>191 ( 3x)</b>	

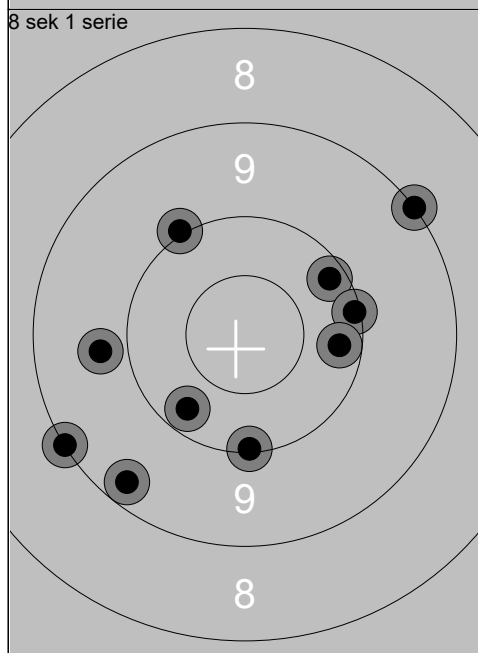

2.70s	10.1	↓
3.55s	9.1	↗
4.62s	10.0	↗
5.66s	9.3	↘
6.55s	9.1	↖
2.71s	10.2	↗
3.79s	9.8	↖
4.75s	10.2	↘
5.80s	10.1	→
6.72s	10.2	→
<b>Serie</b>	<b>96 ( 0x)</b>	
<b>Total</b>	<b>287 ( 3x)</b>	

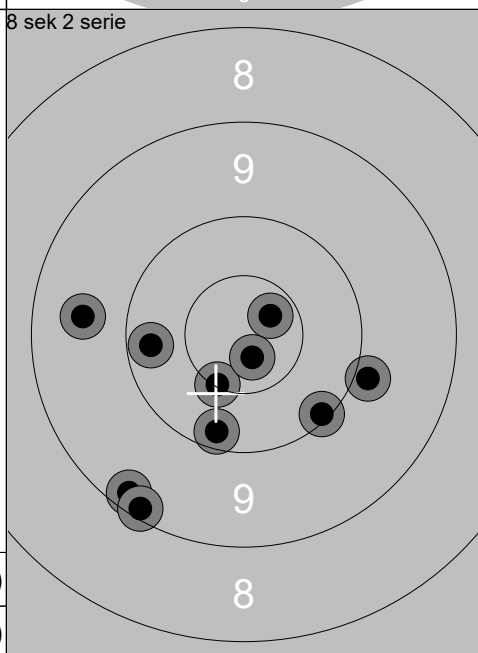

2.52s	10.2	↓
3.40s	10.7x	↗
4.43s	9.6	↖
5.45s	9.2	↘
6.71s	9.2	↘
2.66s	10.1	↘
3.63s	9.9	→
4.70s	10.5x	↘
5.78s	10.8x	↘
6.62s	10.2	↖
<b>Serie</b>	<b>96 ( 3x)</b>	
<b>Total</b>	<b>383 ( 6x)</b>	

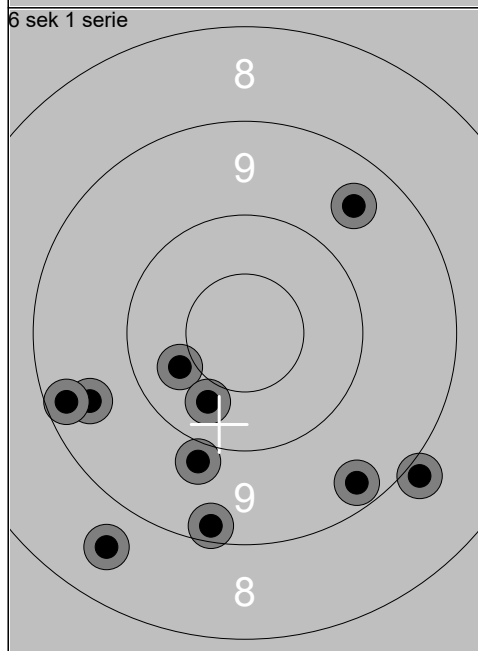

2.43s	9.5	↖
3.18s	9.3	↘
4.09s	10.4	↖
4.88s	8.9	↘
5.58s	9.5	↗
2.35s	9.2	↘
3.04s	8.6	↘
3.84s	10.3	↘
4.59s	9.9	↘
5.31s	9.3	↖
<b>Serie</b>	<b>90 ( 0x)</b>	
<b>Total</b>	<b>473 ( 6x)</b>	

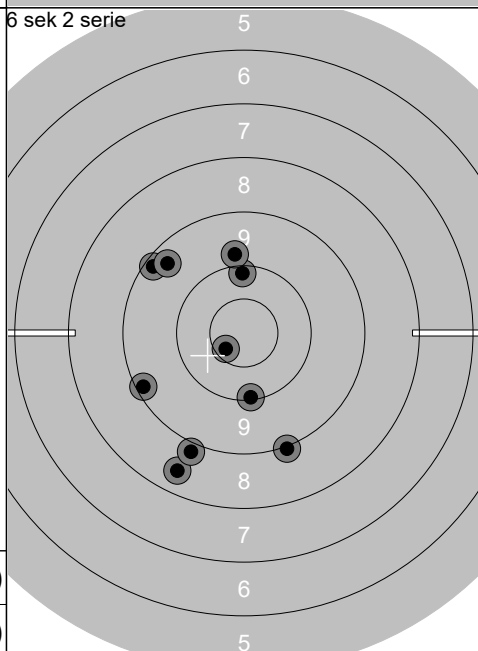

2.27s	9.0	↘
2.94s	8.5	↘
3.81s	10.1	↓
4.63s	9.2	↖
5.31s	10.1	↑
2.21s	10.6x	↖
2.94s	9.2	↖
3.70s	9.4	↗
4.43s	8.9	↘
5.12s	9.9	↑
<b>Serie</b>	<b>91 ( 1x)</b>	
<b>Total</b>	<b>564 ( 7x)</b>	



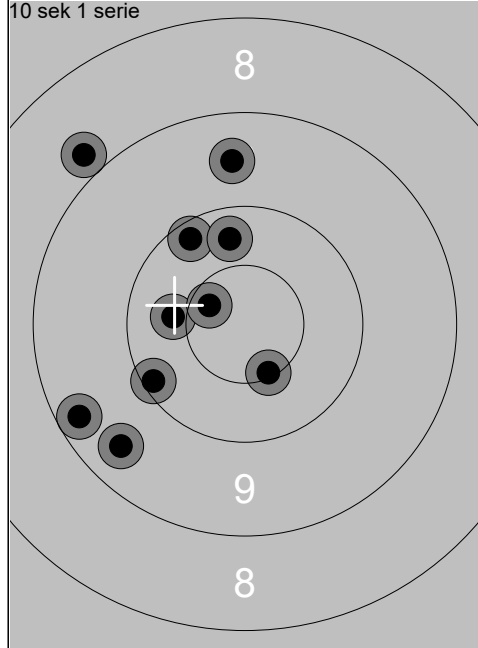

2.82s	10.2	↗
4.30s	9.6	↑
5.89s	10.5x	↘
7.70s	9.3	↖
8.92s	10.4	←
2.63s	10.1	↖
3.98s	8.8	↗
5.21s	10.6x	↖
6.53s	9.5	↘
7.74s	10.3	↑
<b>Serie</b>	<b>95 ( 2x)</b>	
<b>Total</b>	<b>95 ( 2x)</b>	

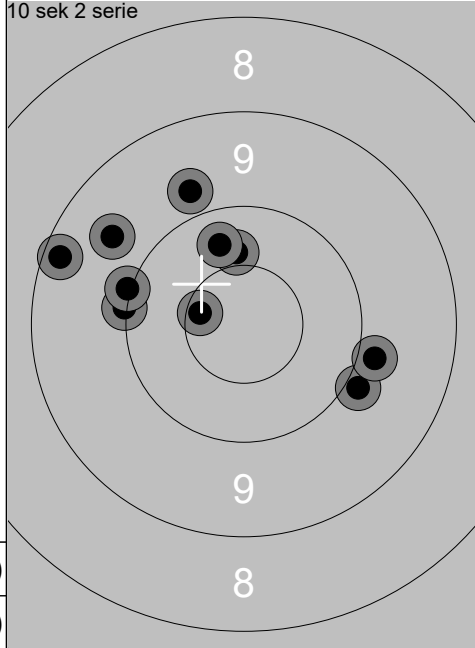

2.33s	9.9	↘
3.82s	9.2	↖
5.60s	9.9	→
7.56s	10.4	↑
8.69s	10.6x	↖
2.65s	10.0	←
4.01s	9.8	↑
5.34s	10.0	←
6.91s	9.6	↖
8.13s	10.3	↑
<b>Serie</b>	<b>95 ( 1x)</b>	
<b>Total</b>	<b>190 ( 3x)</b>	

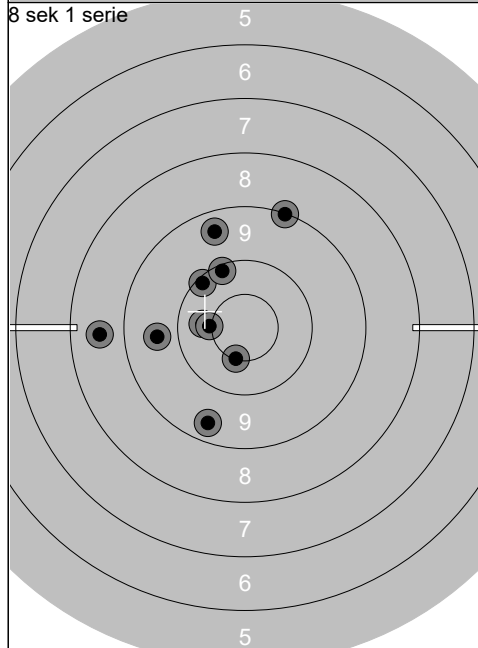

2.37s	9.4	↘
3.58s	10.1	↖
4.73s	10.4	←
5.84s	9.1	↑
7.05s	9.5	↑
2.25s	10.1	↑
3.39s	9.7	←
4.84s	10.5x	↖
6.06s	8.6	←
7.29s	10.5x	↘
<b>Serie</b>	<b>94 ( 2x)</b>	
<b>Total</b>	<b>284 ( 5x)</b>	

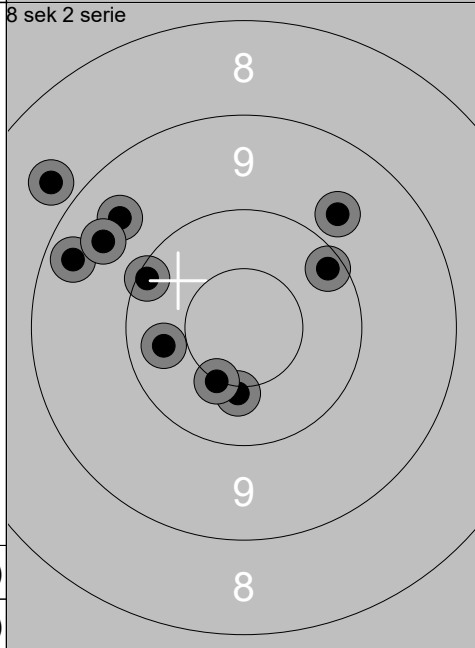

2.44s	9.4	↖
3.81s	10.4x	↘
4.97s	9.6	↖
6.20s	10.1	↖
7.25s	9.6	↖
2.48s	10.3	←
3.76s	10.5x	↘
4.93s	8.8	↖
5.92s	9.8	↗
7.32s	10.2	↗
<b>Serie</b>	<b>94 ( 2x)</b>	
<b>Total</b>	<b>378 ( 7x)</b>	

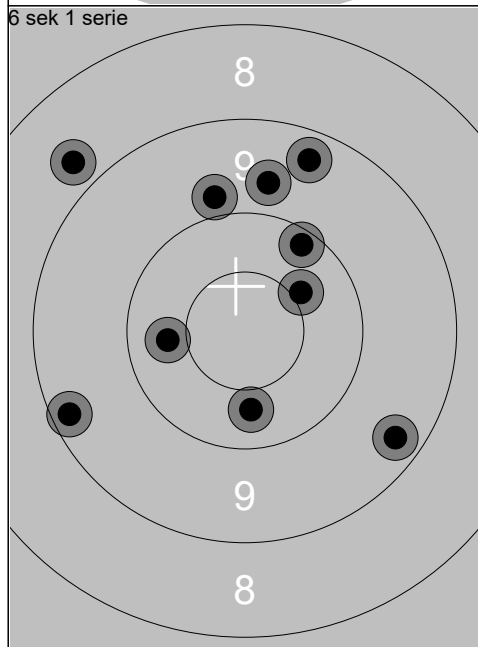

2.15s	9.4	↘
3.17s	10.4x	↗
3.96s	10.3	←
4.76s	8.8	↖
5.66s	9.9	↑
2.40s	10.3	↘
3.19s	9.3	↖
4.07s	9.7	↑
4.99s	9.4	↑
5.83s	10.1	↗
<b>Serie</b>	<b>93 ( 1x)</b>	
<b>Total</b>	<b>471 ( 8x)</b>	

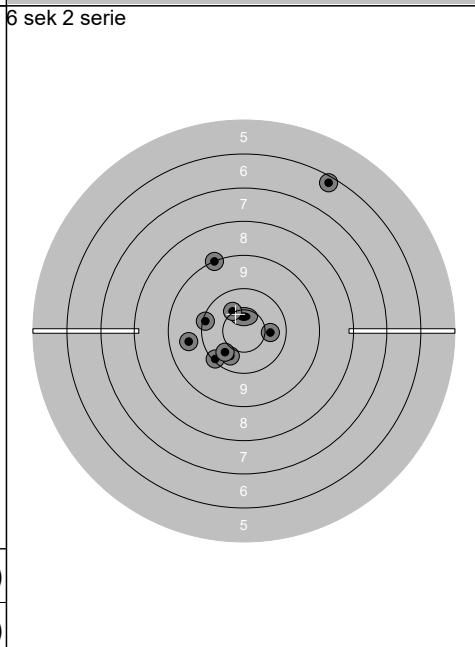

2.50s	10.4	→
3.54s	10.3	↘
4.48s	9.7	←
5.98s	6.3	↗
0.15s		↖
2.27s	10.1	↘
3.01s	9.1	↑
3.87s	10.1	←
4.68s	10.5x	↖
5.53s	10.3	↘
<b>Serie</b>	<b>84 ( 1x)</b>	
<b>Total</b>	<b>555 ( 9x)</b>	

<p>10 sek 1 serie</p>	<p>3.57s 10.2 ↘ 5.30s 10.8x ↘ 6.15s 9.8 → 7.52s 10.7x ↗ 8.50s 10.5x ← 2.58s 9.3 ↑ 4.05s 10.2 ← 5.14s 9.4 ↗ 6.25s 10.7x ↖ 7.60s 10.5x ↘</p> <p>Serie 97 ( 5x) Total 97 ( 5x)</p>	<p>10 sek 2 serie</p>	<p>2.57s 9.3 ← 3.82s 10.7x ↘ 5.20s 10.5x ↘ 6.43s 10.6x ← 8.06s 9.4 ↘ 3.22s 10.3 ← 4.59s 10.0 ↖ 5.95s 10.0 ↓ 7.25s 10.5x ↙ 8.36s 8.4 ↘</p> <p>Serie 96 ( 4x) Total 193 ( 9x)</p>
-----------------------	---	-----------------------	---

<p>8 sek 1 serie</p>	<p>2.67s 10.0 ↗ 3.84s 10.0 ↘ 5.01s 10.7x ↖ 5.89s 10.7x ↘ 6.90s 9.5 ← 2.71s 10.2 ← 3.90s 10.5x ← 4.76s 9.5 ← 5.97s 10.3 ↗ 7.13s 10.0 ↗</p> <p>Serie 98 ( 3x) Total 291 ( 12x)</p>	<p>8 sek 2 serie</p>	<p>2.89s 10.1 ↑ 4.13s 10.0 ↖ 5.19s 10.5x ↗ 6.08s 10.4 ← 7.12s 9.5 → 2.78s 9.6 ↘ 3.92s 10.8x ↗ 4.98s 9.9 ↘ 6.02s 10.0 ↘ 7.35s 10.5x ↘</p> <p>Serie 97 ( 3x) Total 388 ( 15x)</p>
----------------------	--	----------------------	---

<p>6 sek 1 serie</p>	<p>2.20s 10.4x ↖ 3.28s 8.9 ← 4.13s 9.6 → 4.88s 10.7x ← 5.74s 10.0 ↘ 2.70s 9.7 ← 3.59s 9.8 → 4.34s 10.4 → 5.07s 10.2 ↘ 5.98s 9.7 ↖</p> <p>Serie 94 ( 2x) Total 482 ( 17x)</p>	<p>6 sek 2 serie</p>	<p>2.41s 10.5x ↘ 3.52s 9.3 ← 4.32s 9.8 ↗ 5.11s 8.7 ← 5.77s 8.7 ↖ 1.97s 9.5 ↗ 2.96s 9.8 ← 3.81s 9.6 ↗ 4.43s 10.2 ↘ 5.26s 8.0 ↘</p> <p>Serie 89 ( 1x) Total 571 ( 18x)</p>
----------------------	--	----------------------	--

Lag	Skive	Roar Hembre		
2	15			
Hurtigpistol Grov		Trondheim Sportsskyttere		
25.06.2019		NM bane 2019		
		NM Pistol 2019		
10 sek 1 serie		3.18s 9.9 ← 4.42s 9.9 → 5.61s 10.6x ← 7.14s 10.6x ↑ 8.47s 10.3 ↓ 3.75s 10.4 ← 5.33s 10.3 ↓ 6.58s 10.4x ↑ 7.76s 9.3 ↓ 8.78s 10.2 ↓ <b>Serie 97 ( 3x)</b> <b>Total 97 ( 3x)</b>	10 sek 2 serie 	3.04s 10.2 ↙ 4.32s 9.2 ← 5.42s 10.0 ↘ 6.52s 9.3 ↖ 7.70s 10.2 ↙ 2.92s 10.3 → 4.05s 9.9 ↘ 5.12s 10.4x ↑ 6.68s 10.4x ↘ 7.86s 9.6 ↘ <b>Serie 96 ( 2x)</b> <b>Total 193 ( 5x)</b>
8 sek 1 serie		2.81s 10.1 ↓ 3.82s 9.0 ↘ 5.00s 10.2 ↙ 6.13s 8.6 ↓ 7.27s 10.1 ↘ 2.77s 9.9 ↓ 4.00s 9.1 ← 5.18s 10.4 ↓ 6.39s 10.4x ← 8.00s 9.3 ← <b>Serie 94 ( 1x)</b> <b>Total 287 ( 6x)</b>	8 sek 2 serie 	2.35s 10.3 ↑ 3.50s 9.9 → 4.67s 10.5x ↘ 5.88s 10.6x ↙ 7.12s 10.2 ← 2.33s 10.5x → 3.46s 10.5x ↘ 4.63s 10.2 ↑ 5.71s 8.5 ↘ 6.91s 10.2 ↘ <b>Serie 97 ( 4x)</b> <b>Total 384 ( 10x)</b>
6 sek 1 serie		2.02s 10.2 ← 2.98s 8.7 ← 3.84s 10.5x ↙ 4.75s 9.5 ↘ 5.68s 9.3 ↓ 1.99s 10.5x ↙ 3.06s 10.6x ↙ 3.99s 10.0 ↑ 4.94s 9.8 ← 5.83s 9.7 ↑ <b>Serie 94 ( 3x)</b> <b>Total 478 ( 13x)</b>	6 sek 2 serie 	2.17s 8.5 ↙ 3.17s 10.4 → 4.09s 9.7 ↓ 5.01s 10.0 ↗ 5.82s 10.1 ↙ 2.06s 10.0 ↖ 3.07s 9.8 ↑ 3.91s 9.5 → 4.75s 10.3 ↙ 5.59s 8.6 ← <b>Serie 93 ( 0x)</b> <b>Total 571 ( 13x)</b>

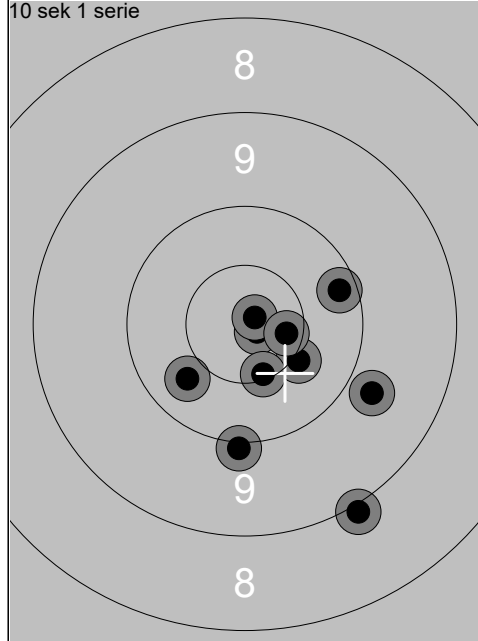

2.67s	10.0	↓
4.18s	10.8x	↘
5.34s	10.4x	↘
6.41s	10.3	↙
7.74s	10.9x	↗
2.68s	10.6x	→
3.86s	9.0	↓
4.97s	9.8	↘
6.14s	10.5x	↓
7.42s	10.2	↗
<b>Serie</b>	<b>98 ( 5x)</b>	
<b>Total</b>	<b>98 ( 5x)</b>	

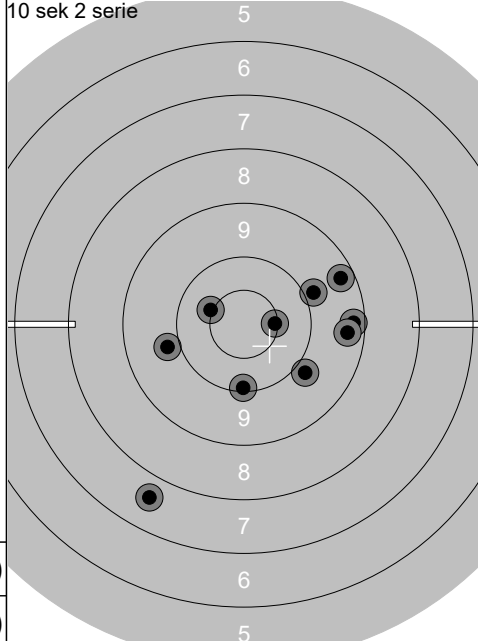

2.66s	9.9	↘
3.72s	9.9	↗
5.20s	10.1	↓
6.44s	9.8	←
7.96s	9.3	→
2.77s	7.7	↓
3.91s	10.5x	↙
5.57s	10.5x	→
7.04s	9.4	→
8.28s	9.3	↗
<b>Serie</b>	<b>91 ( 2x)</b>	
<b>Total</b>	<b>189 ( 7x)</b>	

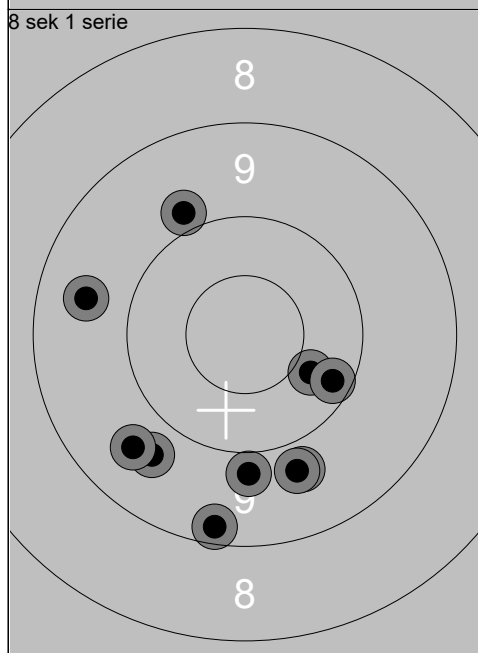

2.49s	9.9	↗
4.26s	9.7	↙
5.08s	9.8	↓
6.00s	9.8	↓
7.03s	9.3	↓
2.38s	10.4	↘
3.34s	9.8	↓
4.36s	9.6	↙
5.43s	9.6	←
6.65s	10.2	↘
<b>Serie</b>	<b>92 ( 0x)</b>	
<b>Total</b>	<b>281 ( 7x)</b>	

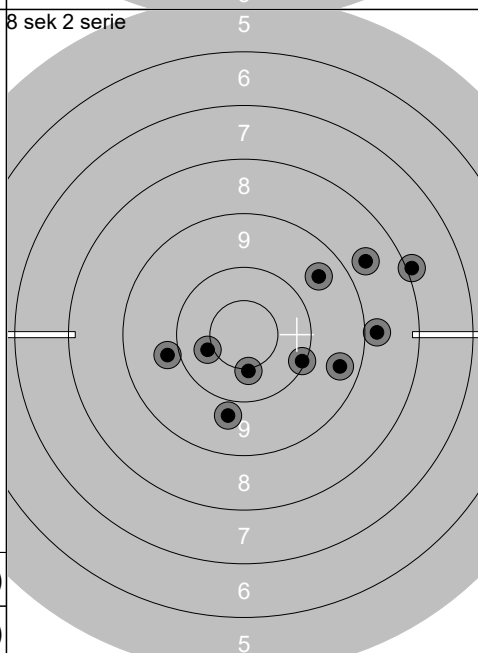

2.54s	9.4	↘
3.53s	9.9	←
4.55s	8.8	→
5.49s	9.6	↗
6.64s	10.4x	↙
2.54s	8.7	↗
3.89s	8.0	↗
4.94s	9.8	↓
6.08s	10.1	↘
7.28s	10.5x	↓
<b>Serie</b>	<b>90 ( 2x)</b>	
<b>Total</b>	<b>371 ( 9x)</b>	

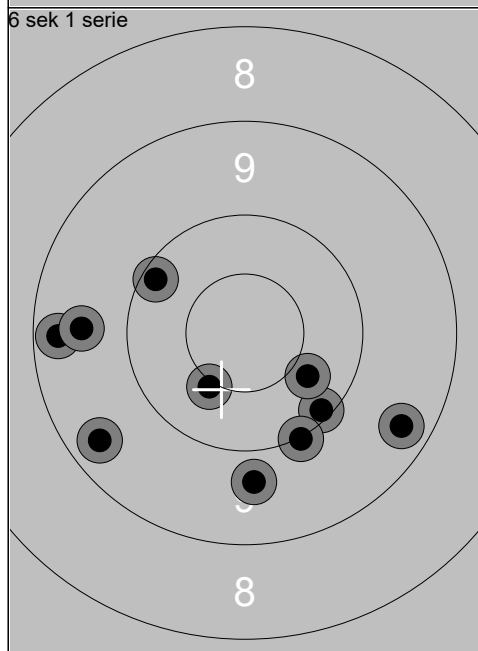

2.04s	10.1	↘
2.82s	10.5x	↙
3.64s	9.7	↓
4.38s	9.3	←
5.32s	10.4	↘
2.15s	9.4	↙
3.02s	9.4	↘
3.80s	10.1	↗
4.57s	9.6	←
5.44s	10.0	↓
<b>Serie</b>	<b>95 ( 1x)</b>	
<b>Total</b>	<b>466 (10x)</b>	

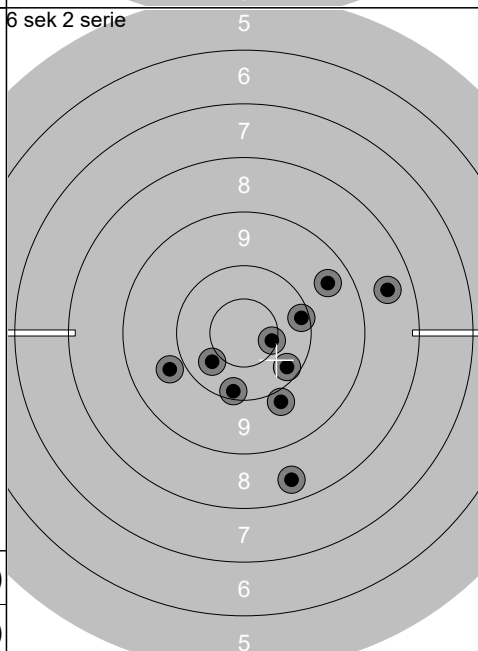

2.20s	9.5	↗
2.99s	10.1	→
4.01s	9.8	←
4.83s	10.4	↙
5.67s	10.6x	→
2.35s	8.5	↓
3.12s	8.5	→
3.94s	10.1	↓
4.68s	10.2	↘
5.65s	9.9	↓
<b>Serie</b>	<b>93 ( 1x)</b>	
<b>Total</b>	<b>559 (11x)</b>	

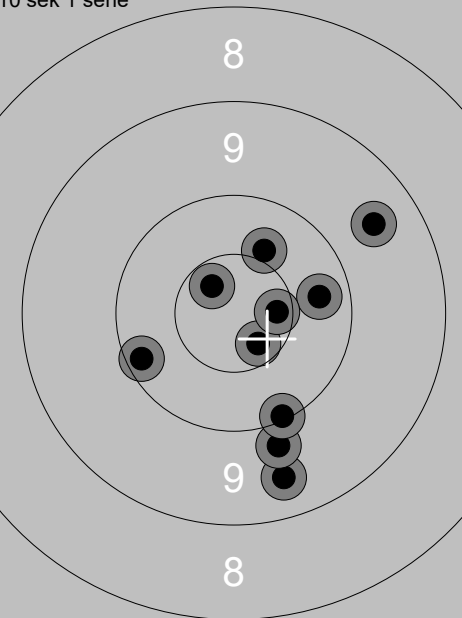
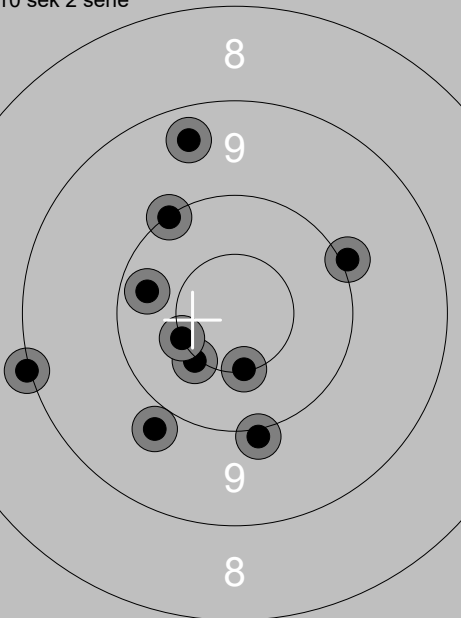
<p>10 sek 1 serie</p> 	<p>2.76s 9.5 ↓ 4.05s 10.7x ↘ 5.55s 9.8 ↓ 6.93s 10.4x ↗ 8.50s 10.3 → 2.80s 10.6x → 4.21s 10.7x ↗ 5.39s 9.6 ↗ 6.43s 10.2 ← 7.88s 10.1 ↓</p> <p>Serie 97 ( 4x) Total 97 ( 4x)</p>	<p>10 sek 2 serie</p> 	<p>2.79s 9.4 ↑ 4.04s 9.0 ← 5.20s 10.3 ← 6.24s 9.8 ↓ 7.53s 10.5x ↘ 2.60s 10.0 ↓ 3.93s 10.0 ↗ 5.05s 10.5x ← 6.28s 10.0 ↖ 7.34s 10.5x ↓</p> <p>Serie 97 ( 3x) Total 194 ( 7x)</p>
--	--	--	--

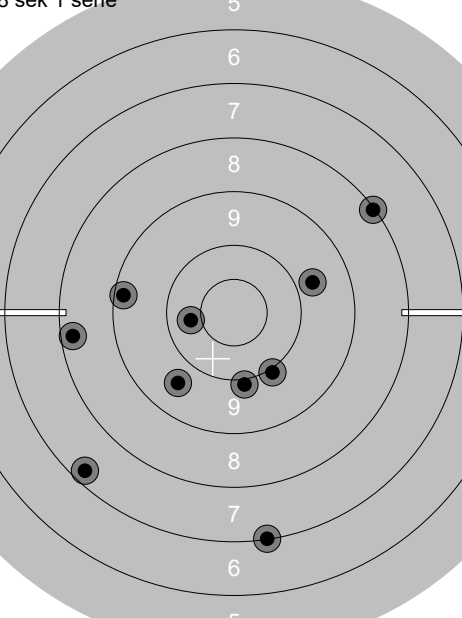
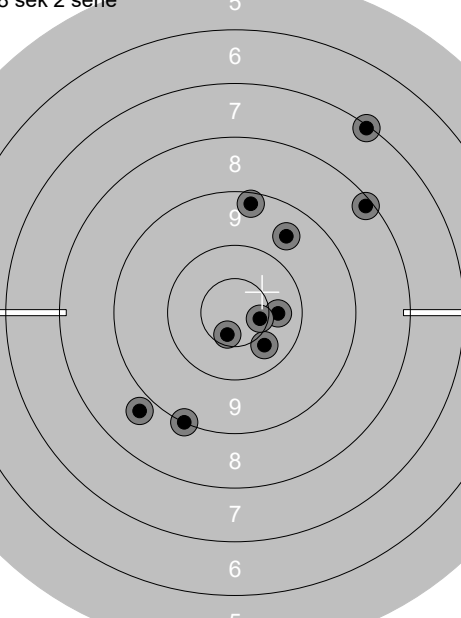
<p>8 sek 1 serie</p> 	<p>2.74s 8.1 ↗ 3.73s 9.7 ↓ 4.84s 9.7 → 5.89s 10.0 ↓ 7.21s 10.4 ← 1.70s 7.1 ↓ 2.72s 10.0 ↓ 3.80s 8.3 ← 4.67s 7.3 ↓ 5.95s 9.2 ←</p> <p>Serie 87 ( 0x) Total 281 ( 7x)</p>	<p>8 sek 2 serie</p> 	<p>2.42s 10.3 ↘ 3.31s 10.6x ↓ 4.29s 9.1 ↓ 5.52s 8.8 ← 6.63s 10.4 → 2.47s 7.1 ↗ 3.45s 9.3 ↑ 4.46s 8.2 ↗ 5.31s 10.6x → 6.61s 9.6 ↗</p> <p>Serie 90 ( 2x) Total 371 ( 9x)</p>
--	---	--	--

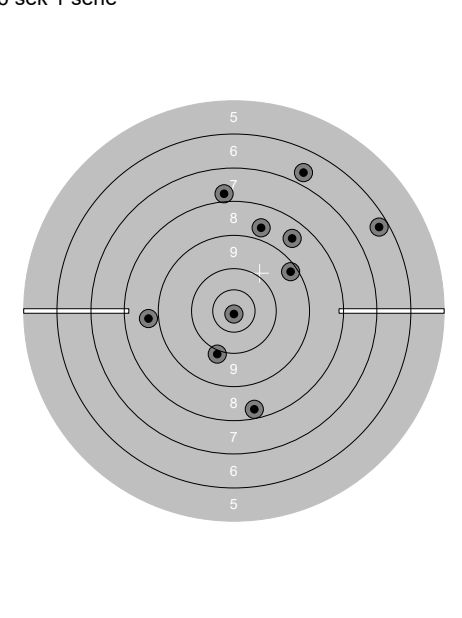
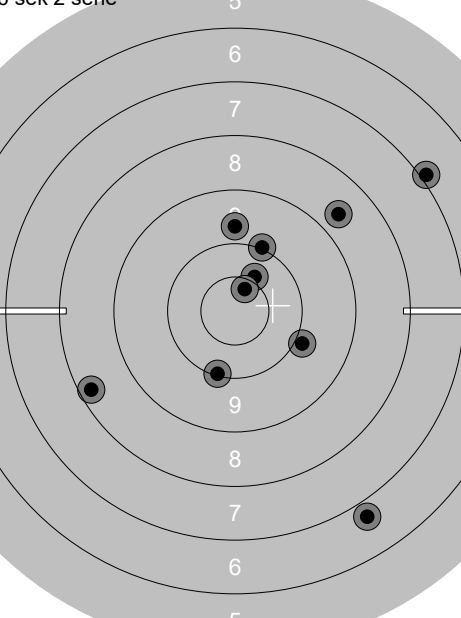
<p>6 sek 1 serie</p> 	<p>1.80s 9.3 ↗ 2.45s 8.3 ↓ 3.29s 9.9 ↓ 4.26s 10.9x ↓ 5.15s 8.8 ← 2.04s 8.5 ↗ 2.67s 8.7 ↗ 3.76s 6.7 ↗ 4.51s 6.3 ↗ 5.51s 7.8 ↑</p> <p>Serie 79 ( 1x) Total 450 ( 10x)</p>	<p>6 sek 2 serie</p> 	<p>1.80s 7.0 ↗ 2.52s 9.9 → 3.31s 8.3 ← 4.01s 9.7 ↑ 4.79s 10.4x ↗ 2.04s 8.7 ↗ 2.83s 10.1 ↓ 3.73s 10.6x ↗ 4.58s 10.0 ↗ 5.26s 6.8 ↓</p> <p>Serie 87 ( 2x) Total 537 ( 12x)</p>
---	---	---	---

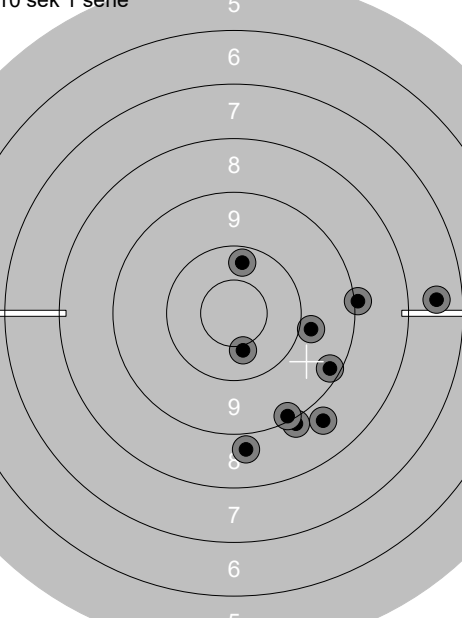
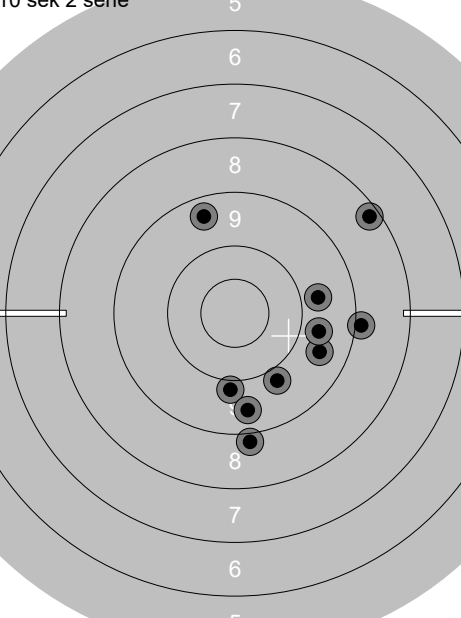
<p>10 sek 1 serie</p> 	<p>2.63s 9.3 ↘ 3.94s 10.3 ↑ 5.48s 9.0 ↓ 6.70s 9.2 ↓ 8.43s 9.0 → 2.73s 8.7 ↓ 3.89s 10.4x ↓ 5.37s 8.8 ↓ 6.71s 9.9 → 8.22s 7.5 →</p> <p><b>Serie 88 ( 1x)</b> <b>Total 88 ( 1x)</b></p>	<p>10 sek 2 serie</p> 	<p>2.91s 9.4 ↑ 4.13s 9.6 → 5.60s 9.7 → 6.75s 9.8 ↓ 8.14s 9.7 → 2.88s 8.2 ↗ 3.88s 9.0 → 4.86s 9.9 ↓ 6.08s 9.5 ↓ 7.41s 8.9 ↓</p> <p><b>Serie 88 ( 0x)</b> <b>Total 176 ( 1x)</b></p>
--	--	--	--

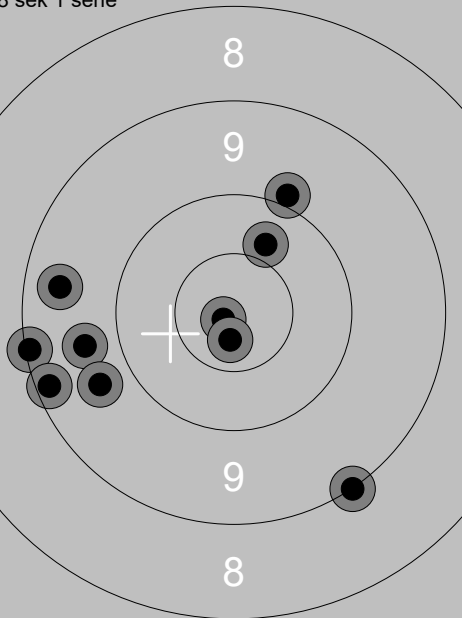
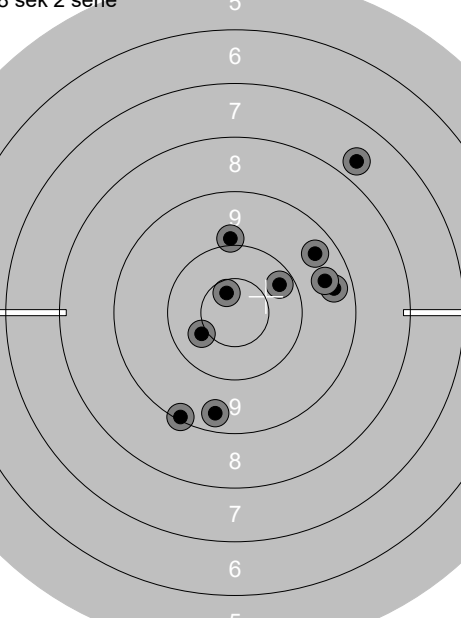
<p>8 sek 1 serie</p> 	<p>2.64s 9.9 ↑ 3.65s 9.7 ← 4.58s 10.8x ↙ 5.58s 10.4 ↑ 6.56s 10.7x ↓ 2.43s 9.1 ← 3.62s 9.7 ← 4.84s 9.1 ↓ 5.65s 9.5 ← 6.45s 9.2 ←</p> <p><b>Serie 93 ( 2x)</b> <b>Total 269 ( 3x)</b></p>	<p>8 sek 2 serie</p> 	<p>2.29s 9.1 ↓ 3.20s 9.4 → 4.01s 9.5 ↗ 4.84s 10.2 ↗ 6.09s 9.9 ↑ 2.31s 7.7 ↗ 3.38s 9.4 ↓ 4.34s 10.4x ↙ 5.32s 9.5 → 6.33s 10.7x ↗</p> <p><b>Serie 91 ( 2x)</b> <b>Total 360 ( 5x)</b></p>
--	---	--	---

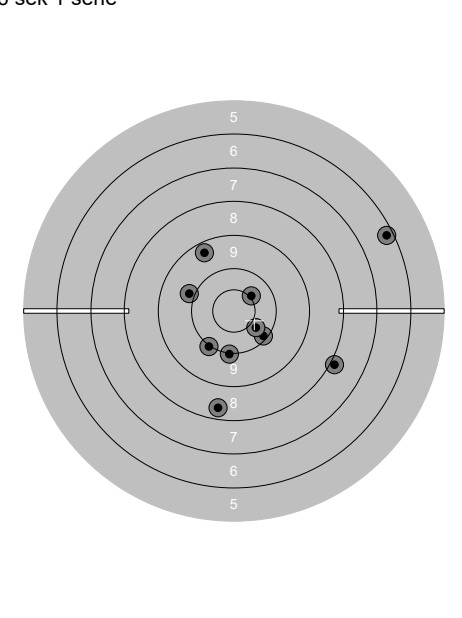
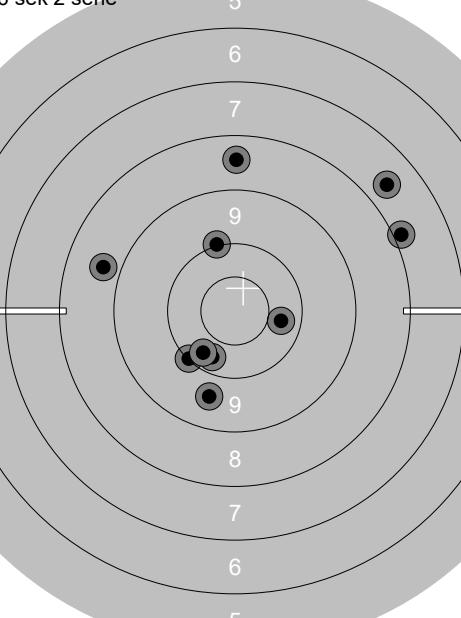
<p>6 sek 1 serie</p> 	<p>2.20s 9.4 ↑ 3.02s 9.9 ← 3.68s 8.4 ↓ 4.48s 10.1 ↓ 5.36s 10.5x ↗ 2.31s 10.4 ↓ 3.07s 7.9 → 3.96s 10.0 ↓ 4.80s 6.3 ↗ 5.69s 10.0 ↓</p> <p><b>Serie 89 ( 1x)</b> <b>Total 449 ( 6x)</b></p>	<p>6 sek 2 serie</p> 	<p>2.25s 10.3 → 3.08s 7.9 → 3.82s 10.1 ↙ 4.46s 7.7 ↗ 5.29s 8.5 ↑ 2.21s 9.7 ↓ 2.94s 8.7 ← 3.76s 10.3 ↓ 4.59s 10.0 ↑ 5.49s 10.2 ↙</p> <p><b>Serie 89 ( 0x)</b> <b>Total 538 ( 6x)</b></p>
---	--	---	---

<p>10 sek 1 serie</p>	<p>2.78s 10.7x ↙ 4.12s 9.7 ← 5.52s 10.5x ➤ 7.11s 10.2 ← 8.26s 10.6x ↓ 3.14s 10.1 ➔ 4.34s 9.1 ➔ 5.58s 10.7x ↓ 7.03s 10.3 ↑ 8.14s 10.1 ↓</p> <p>Serie 98 ( 4x) Total 98 ( 4x)</p>	<p>10 sek 2 serie</p>	<p>3.04s 9.6 ← 4.44s 9.9 ↓ 5.56s 10.1 ← 7.01s 10.7x ↓ 8.02s 10.0 ↓ 2.97s 10.1 ➔ 4.30s 8.9 ← 5.73s 10.4x ➔ 6.82s 10.1 ↓ 7.98s 10.0 ↓</p> <p>Serie 96 ( 2x) Total 194 ( 6x)</p>
-----------------------	---	-----------------------	---

<p>8 sek 1 serie</p>	<p>2.84s 10.5x ↙ 3.96s 10.5x ↙ 5.12s 10.2 ↙ 5.88s 10.4x ↓ 6.71s 9.6 ↙ 2.91s 10.2 ↓ 3.92s 10.4 ↓ 4.83s 10.4 ↙ 5.84s 8.0 ↗ 6.84s 8.0 ↙</p> <p>Serie 95 ( 3x) Total 289 ( 9x)</p>	<p>8 sek 2 serie</p>	<p>2.59s 10.3 ← 3.78s 10.0 ↗ 4.90s 9.8 ↙ 5.89s 10.7x ↗ 6.84s 9.1 ↙ 2.52s 9.9 ↗ 3.55s 10.2 ↙ 4.76s 10.2 ↗ 5.78s 9.2 ← 6.73s 10.1 ↘</p> <p>Serie 96 ( 1x) Total 385 ( 10x)</p>
----------------------	--	----------------------	--

<p>6 sek 1 serie</p>	<p>2.16s 10.6x ↑ 3.08s 10.1 ↓ 3.82s 10.9x ↙ 4.68s 10.2 ↓ 5.48s 10.6x ↙ 2.42s 9.4 ↓ 3.32s 8.2 ↓ 4.25s 9.4 ← 4.99s 7.6 ↓ 5.79s 10.2 ↓</p> <p>Serie 93 ( 3x) Total 478 ( 13x)</p>	<p>6 sek 2 serie</p>	<p>2.23s 10.4x ↙ 3.17s 9.5 ← 4.01s 10.0 ↑ 4.86s 9.7 ↑ 5.62s 9.3 ↑ 2.37s 9.7 ➔ 3.27s 9.6 ← 4.13s 9.7 ↗ 4.92s 9.9 ← 5.66s 10.3 ←</p> <p>Serie 93 ( 1x) Total 571 ( 14x)</p>
----------------------	--	----------------------	---

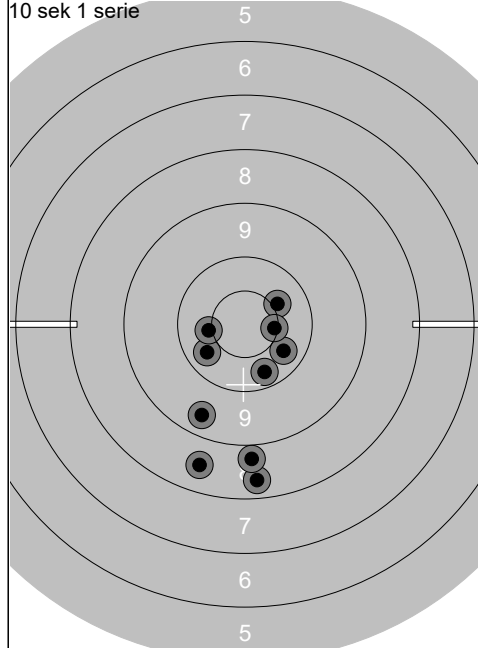

2.52s	10.3	↙
4.05s	10.3	↘
5.40s	10.4x	↗
6.72s	8.4	↓
8.06s	8.6	↓
2.46s	10.5x	←
3.79s	8.8	↓
5.15s	10.2	↓
6.59s	9.5	↓
7.89s	10.5x	→
<b>Serie</b>	<b>93 ( 3x)</b>	
<b>Total</b>	<b>93 ( 3x)</b>	

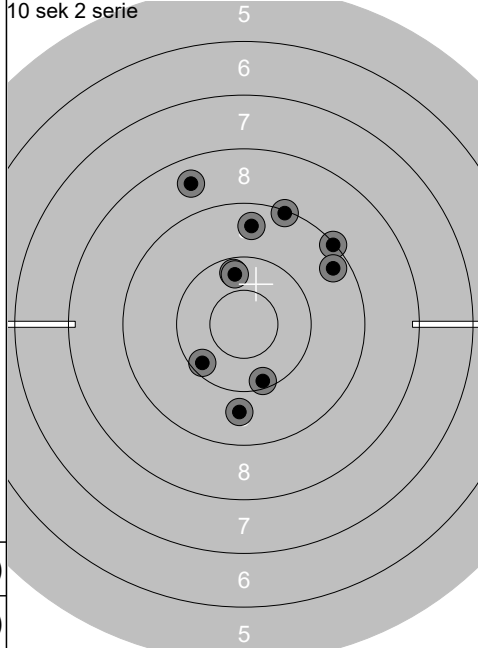

3.02s	8.5	↗
4.13s	10.1	↓
5.30s	10.2	↙
6.37s	10.2	↑
7.52s	9.1	↑
3.03s	10.3	↑
4.16s	9.1	↗
5.36s	9.4	↗
6.66s	9.5	↑
7.93s	9.7	↓
<b>Serie</b>	<b>93 ( 0x)</b>	
<b>Total</b>	<b>186 ( 3x)</b>	

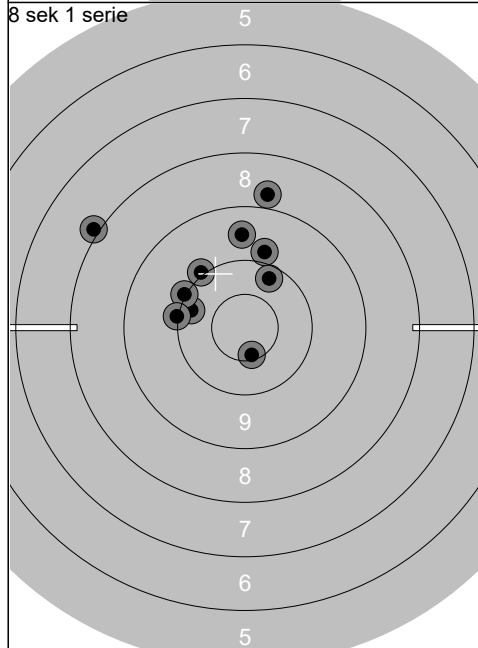

2.60s	8.0	↙
3.71s	9.6	↑
4.65s	10.2	↗
5.73s	10.2	↙
6.79s	8.8	↑
2.66s	10.0	↙
3.93s	10.6x	↓
5.08s	10.0	↙
6.34s	9.9	↑
7.71s	10.0	↖
<b>Serie</b>	<b>94 ( 1x)</b>	
<b>Total</b>	<b>280 ( 4x)</b>	

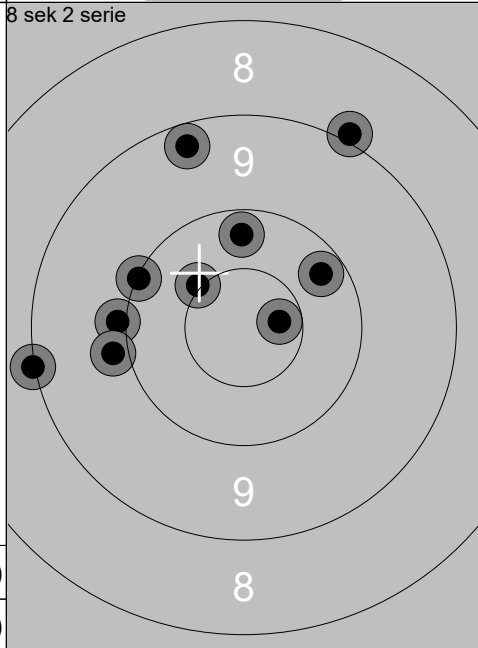

2.48s	9.3	↑
3.70s	10.2	↗
4.86s	10.5x	↖
5.90s	10.2	↑
6.96s	10.0	↙
2.50s	9.0	↗
3.64s	10.0	←
4.84s	10.7x	→
5.88s	9.9	←
6.93s	9.0	←
<b>Serie</b>	<b>96 ( 2x)</b>	
<b>Total</b>	<b>376 ( 6x)</b>	

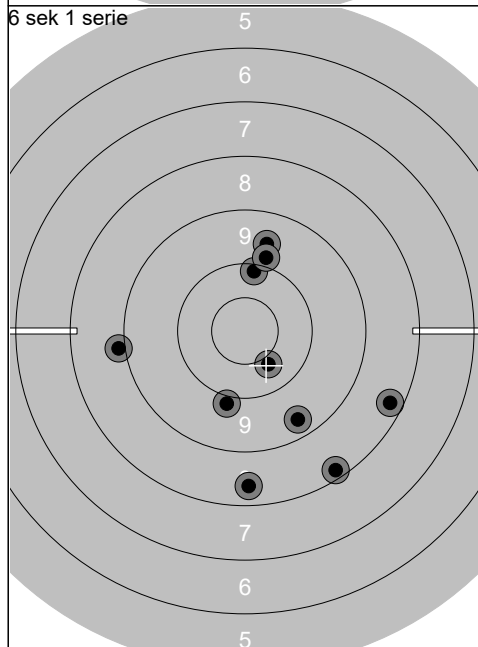

2.34s	8.9	←
3.09s	8.4	↓
4.07s	9.6	↑
4.91s	10.1	↑
5.84s	9.9	↑
2.19s	8.3	↘
3.19s	8.2	↓
3.95s	10.4	↓
4.72s	9.4	↓
5.54s	9.9	↓
<b>Serie</b>	<b>88 ( 0x)</b>	
<b>Total</b>	<b>464 ( 6x)</b>	

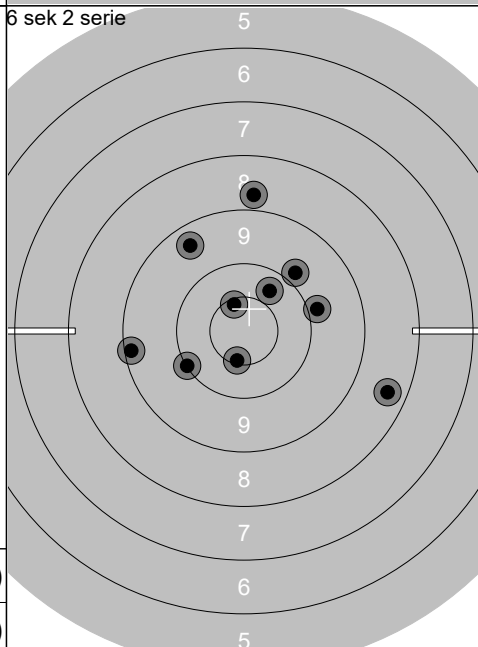

2.14s	10.6x	↖
3.11s	10.3	↗
3.87s	9.9	↗
4.76s	8.8	↑
5.76s	8.4	↘
2.16s	9.2	←
3.06s	9.4	↖
4.04s	9.9	→
4.92s	10.5x	↓
5.70s	10.0	↙
<b>Serie</b>	<b>92 ( 2x)</b>	
<b>Total</b>	<b>556 ( 8x)</b>	



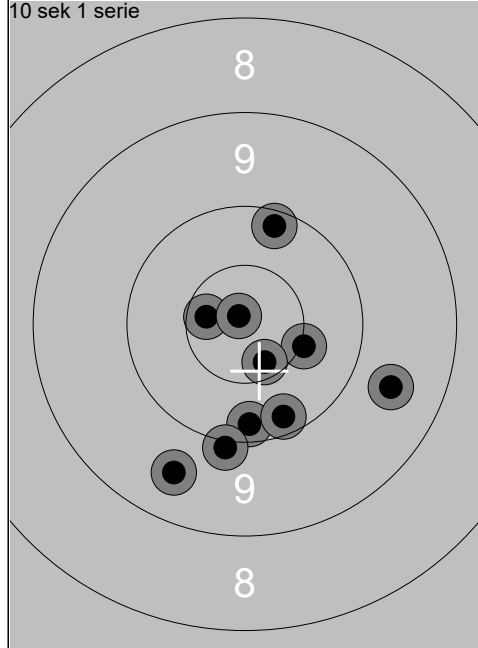

2.50s	10.2	↗
4.04s	10.5x	→
5.30s	10.2	↓
6.64s	9.6	→
8.19s	10.0	↓
2.35s	10.6x	←
4.11s	10.9x	↗
6.27s	10.6x	↓
7.70s	9.6	↓
9.05s	10.2	↓
<b>Serie</b>	<b>98 ( 4x)</b>	
<b>Total</b>	<b>98 ( 4x)</b>	

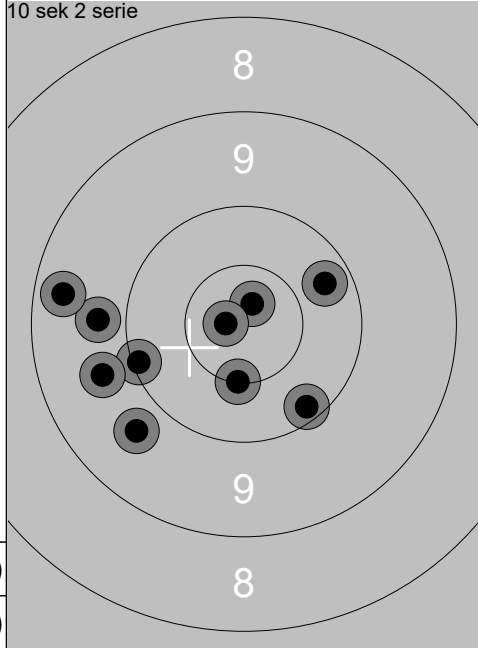

2.36s	10.1	↘
4.08s	9.8	←
5.71s	10.1	←
7.32s	10.8x	↗
8.74s	9.7	↘
2.74s	10.2	↗
4.13s	10.5x	↓
5.34s	9.7	←
6.66s	10.8x	←
8.43s	9.4	←
<b>Serie</b>	<b>96 ( 3x)</b>	
<b>Total</b>	<b>194 ( 7x)</b>	

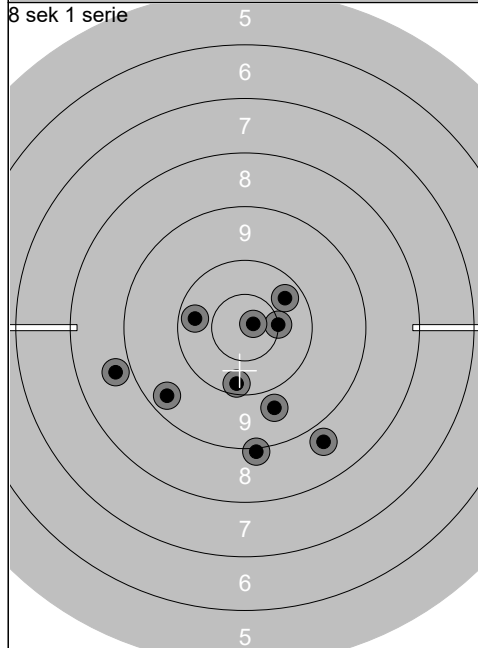

2.12s	8.8	←
3.36s	9.0	↓
4.23s	9.7	↓
5.20s	8.7	↘
6.68s	10.2	↓
2.00s	10.3	←
2.90s	10.5x	→
3.98s	10.3	↗
4.79s	10.8x	→
5.97s	9.4	↘
<b>Serie</b>	<b>93 ( 2x)</b>	
<b>Total</b>	<b>287 ( 9x)</b>	

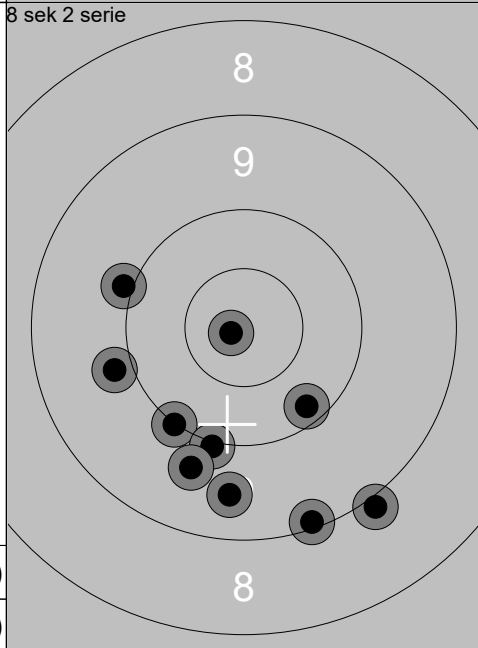

2.22s	10.2	↘
3.08s	10.0	←
4.24s	10.8x	←
5.24s	10.0	↘
6.39s	10.0	↓
1.84s	9.9	←
2.78s	9.0	↘
4.05s	9.5	↓
4.97s	9.1	↘
6.44s	9.7	↘
<b>Serie</b>	<b>95 ( 1x)</b>	
<b>Total</b>	<b>382 (10x)</b>	

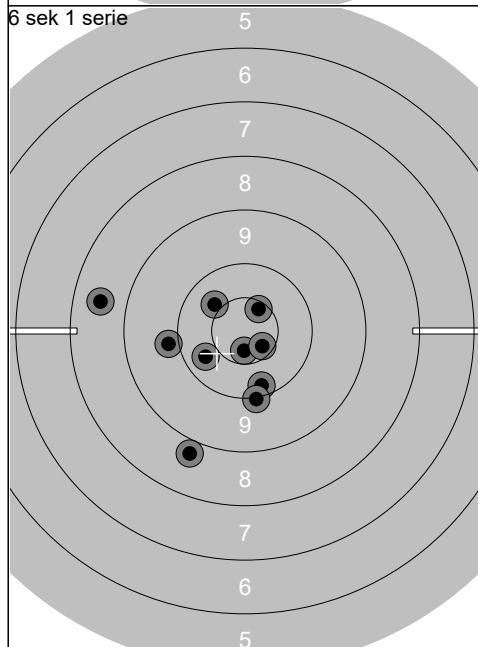

1.82s	10.4	↖
2.73s	8.6	←
3.41s	10.7x	↓
4.20s	10.2	↓
4.95s	10.3	←
1.67s	9.9	←
2.71s	10.6x	↘
3.54s	10.0	↓
4.68s	8.8	↘
5.54s	10.6x	↗
<b>Serie</b>	<b>95 ( 3x)</b>	
<b>Total</b>	<b>477 (13x)</b>	

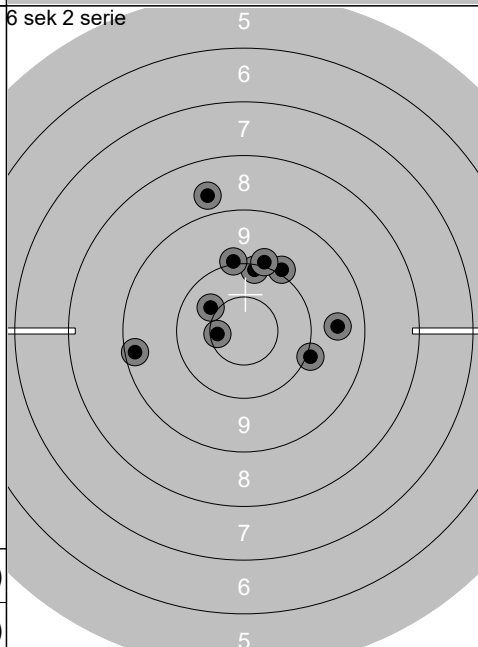

1.72s	10.0	↗
2.60s	10.1	↑
3.80s	10.4	↖
4.59s	10.0	→
5.57s	9.6	→
1.78s	10.0	↑
2.61s	10.0	↑
3.34s	10.6x	←
4.21s	8.7	↑
5.25s	9.3	←
<b>Serie</b>	<b>96 ( 1x)</b>	
<b>Total</b>	<b>573 (14x)</b>	

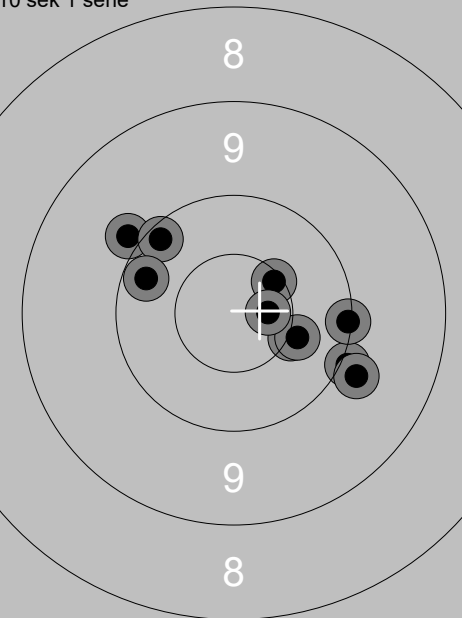
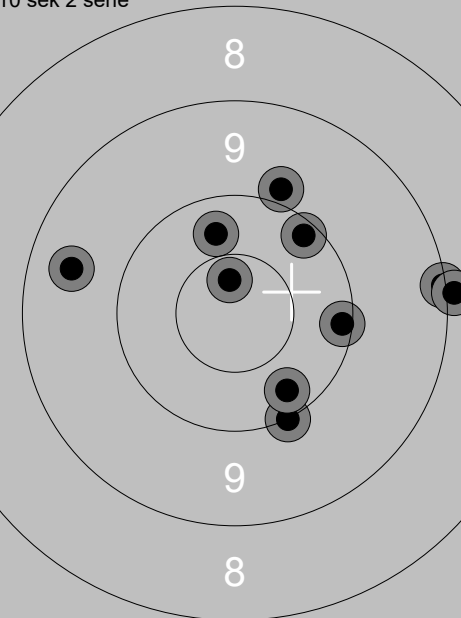
<p>10 sek 1 serie</p> 	<p>2.75s 10.0 ➤</p> <p>4.11s 9.9 ↗</p> <p>5.56s 9.9 ➤</p> <p>6.87s 10.6x ↗</p> <p>8.05s 10.1 ↗</p> <p>2.52s 10.5x ➤</p> <p>3.70s 10.4x ➤</p> <p>5.05s 10.1 ➔</p> <p>6.28s 10.7x ➔</p> <p>7.36s 10.2 ↖</p> <p><b>Serie 98 ( 4x)</b></p> <p><b>Total 98 ( 4x)</b></p>	<p>10 sek 2 serie</p> 	<p>2.81s 10.0 ↘</p> <p>4.11s 10.3 ↑</p> <p>5.31s 10.1 ↗</p> <p>6.45s 10.1 ➔</p> <p>7.62s 10.7x ↑</p> <p>2.58s 9.1 ➔</p> <p>3.94s 9.5 ↖</p> <p>5.12s 9.0 ➔</p> <p>6.43s 9.9 ↑</p> <p>7.58s 10.2 ↘</p> <p><b>Serie 96 ( 1x)</b></p> <p><b>Total 194 ( 5x)</b></p>
--	---	--	---

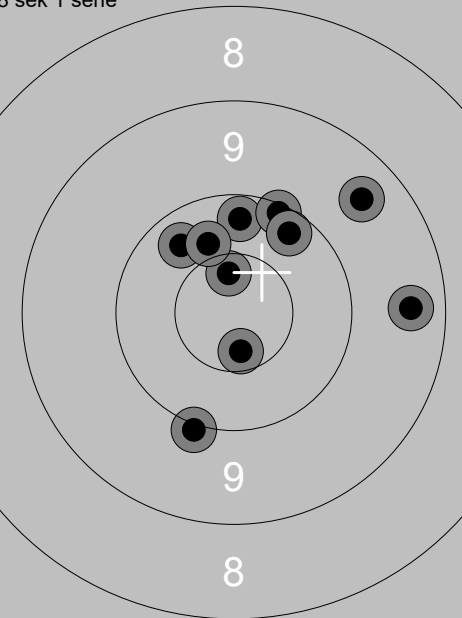
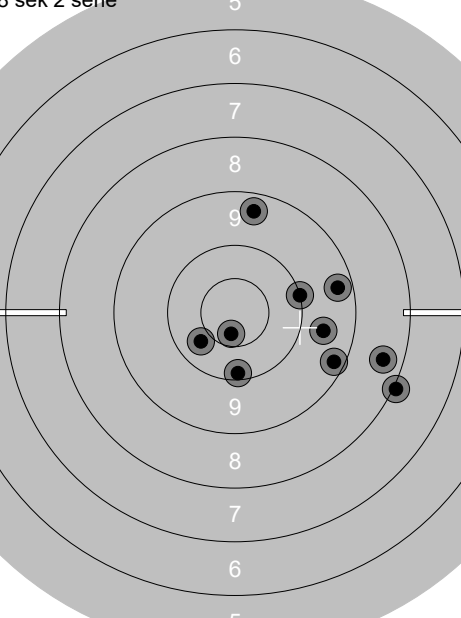
<p>8 sek 1 serie</p> 	<p>2.27s 9.4 ➔</p> <p>3.55s 10.2 ↑</p> <p>4.63s 9.5 ↗</p> <p>5.65s 10.1 ↗</p> <p>6.82s 10.3 ↗</p> <p>2.45s 10.2 ↗</p> <p>3.56s 10.6x ↓</p> <p>4.69s 10.6x ↑</p> <p>5.72s 10.4 ↑</p> <p>6.90s 10.0 ↓</p> <p><b>Serie 98 ( 2x)</b></p> <p><b>Total 292 ( 7x)</b></p>	<p>8 sek 2 serie</p> 	<p>2.25s 8.0 ➤</p> <p>3.26s 10.7x ↓</p> <p>4.34s 10.1 ↓</p> <p>5.28s 8.4 ➤</p> <p>6.28s 9.4 ➔</p> <p>2.39s 9.6 ➤</p> <p>3.65s 9.4 ↑</p> <p>4.74s 10.3 ↙</p> <p>5.86s 9.3 ➤</p> <p>6.91s 10.0 ➔</p> <p><b>Serie 92 ( 1x)</b></p> <p><b>Total 384 ( 8x)</b></p>
--	--	--	---

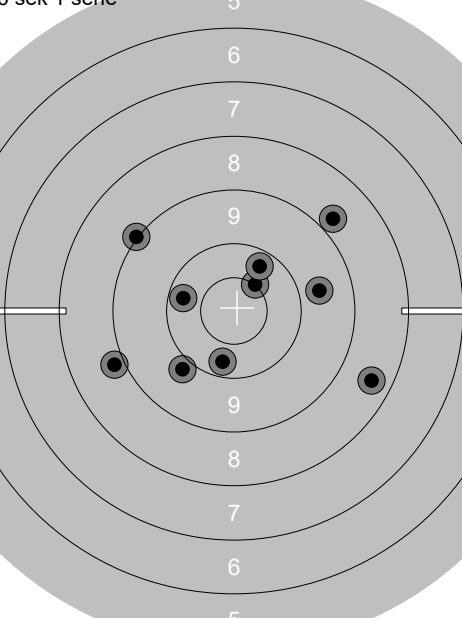
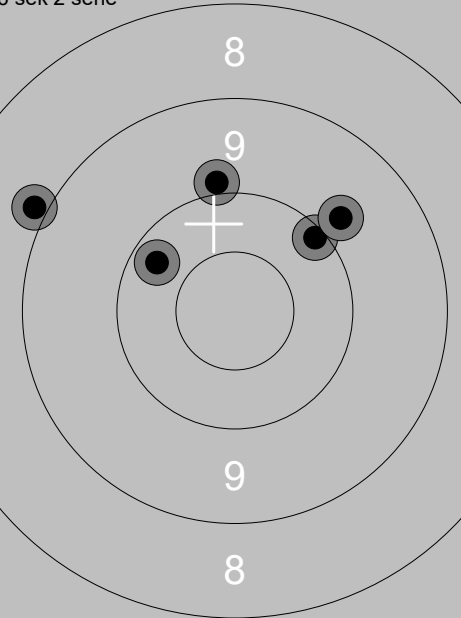
<p>6 sek 1 serie</p> 	<p>1.86s 10.2 ↖</p> <p>2.81s 10.2 ↓</p> <p>3.63s 9.9 ↙</p> <p>4.40s 8.9 ↖</p> <p>5.21s 9.0 ↖</p> <p>1.92s 8.5 ➤</p> <p>2.80s 9.7 ➔</p> <p>3.62s 8.8 ↗</p> <p>4.46s 10.5x ↗</p> <p>5.31s 10.3 ↗</p> <p><b>Serie 91 ( 1x)</b></p> <p><b>Total 475 ( 9x)</b></p>	<p>6 sek 2 serie</p> 	<p>2.13s 10.1 ↗</p> <p>3.12s 9.9 ↑</p> <p>4.04s 10.2 ↖</p> <p>4.99s 9.8 ↗</p> <p>5.89s 8.9 ↖</p> <p><b>Serie 46 ( 0x)</b></p> <p><b>Total 521 ( 9x)</b></p>
---	---	---	---

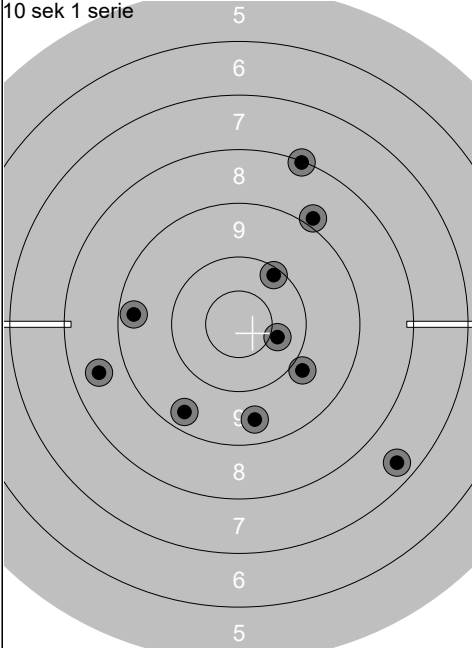
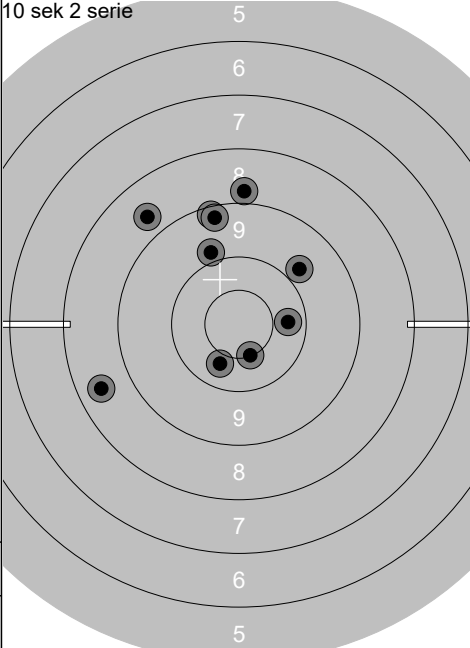
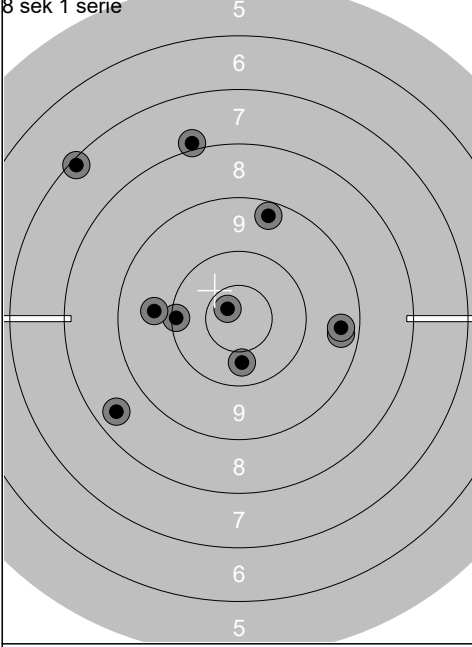
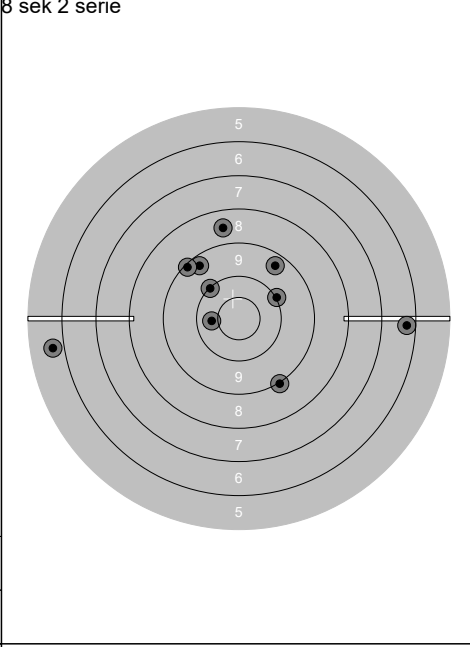
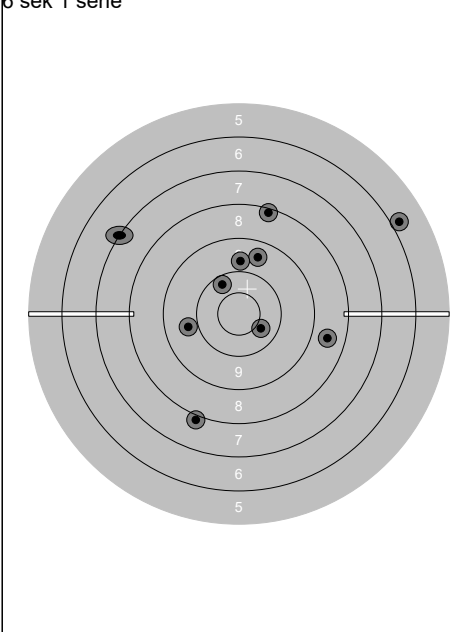
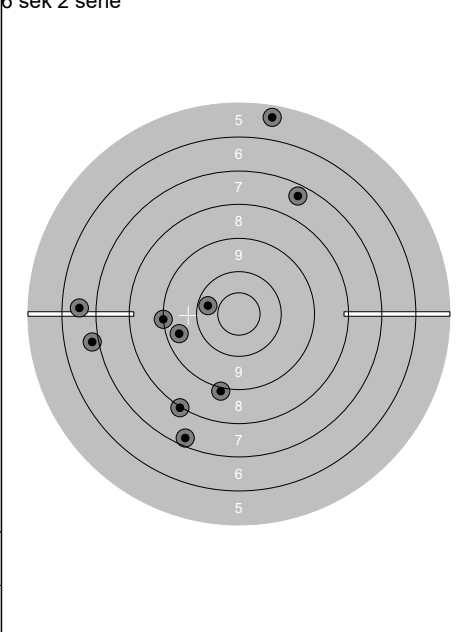
Lag	Skive	Audun Kvandal		
Hurtigpistol Grov	Odde Pk	A		
25.06.2019	NM bane 2019	NM Pistol 2019		
10 sek 1 serie		2.81s 8.1 ↗ 4.47s 9.5 ↓ 5.77s 8.6 ← 6.80s 9.4 ↓ 7.78s 9.9 ↘ 3.26s 10.4 → 4.84s 9.4 ← 6.32s 8.9 ↗ 7.53s 10.1 ↗ 8.76s 7.4 ↘ Serie 87 ( 0x) Total 87 ( 0x)		3.03s 9.2 ↗ 4.57s 8.7 ↘ 5.54s 9.8 ↗ 6.62s 9.9 ↗ 7.68s 10.5x ↓ 3.01s 9.3 ↗ 4.21s 8.8 ↗ 5.27s 10.4 ↓ 6.49s 8.5 ← 7.38s 10.3 → Serie 90 ( 1x) Total 177 ( 1x)
8 sek 1 serie		2.52s 7.9 ↗ 3.48s 9.3 ↗ 4.82s 10.1 ← 5.74s 7.2 ↘ 6.47s 9.4 → 2.50s 9.7 ← 3.96s 9.4 → 4.84s 10.7x ↘ 6.03s 8.5 ← 6.91s 10.4 ↓ Serie 88 ( 1x) Total 265 ( 2x)		2.69s 9.3 ↘ 3.67s 9.4 ↗ 4.74s 9.2 ↘ 5.70s 5.7 ← 6.60s 10.0 ↗ 2.75s 8.6 ↗ 3.73s 10.0 ↘ 4.78s 6.3 → 5.62s 10.4 ← 6.53s 9.0 ↘ Serie 85 ( 0x) Total 350 ( 2x)
6 sek 1 serie		2.58s 8.2 ↗ 3.35s 10.2 ↘ 4.08s 9.5 ↗ 4.75s 5.8 ↗ 5.45s 7.9 ↓ 2.74s 9.8 ← 4.26s 9.7 ↗ 4.99s 8.6 → 5.65s 10.4 ↘ 0.05s ↘ Serie 75 ( 0x) Total 425 ( 2x)		2.08s 9.1 ← 3.13s 6.9 ← 3.89s 6.6 ← 4.70s 5.4 ↗ 5.64s 9.0 ↓ 2.33s 10.3 ← 3.32s 7.4 ↗ 4.01s 9.5 ← 4.91s 7.3 ↓ 5.55s 8.0 ↓ Serie 76 ( 0x) Total 501 ( 2x)

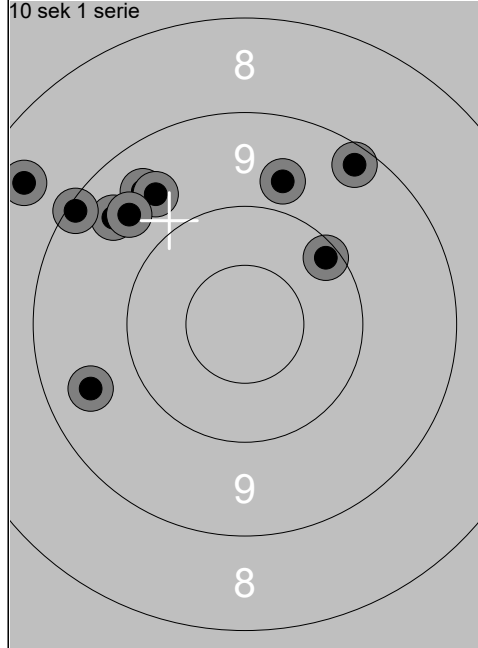

2.85s	9.8	↗
4.51s	9.5	↖
5.91s	9.5	↖
7.31s	9.3	↗
8.40s	9.6	↖
2.52s	9.2	↖
3.88s	8.5	↖
5.19s	9.6	↗
6.44s	9.5	↙
7.50s	10.1	↗
<b>Serie</b>	<b>90 ( 0x)</b>	
<b>Total</b>	<b>90 ( 0x)</b>	

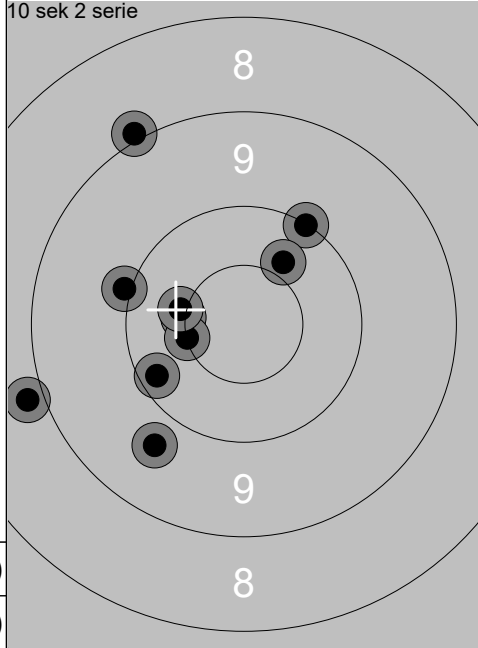

2.85s	8.9	↙
4.17s	10.5x	↙
5.36s	10.0	↗
6.86s	10.5x	↙
8.11s	10.4	↗
2.91s	9.7	↘
4.23s	9.0	↖
5.41s	10.0	↙
6.76s	10.4x	↙
8.13s	10.2	↙
<b>Serie</b>	<b>96 ( 3x)</b>	
<b>Total</b>	<b>186 ( 3x)</b>	

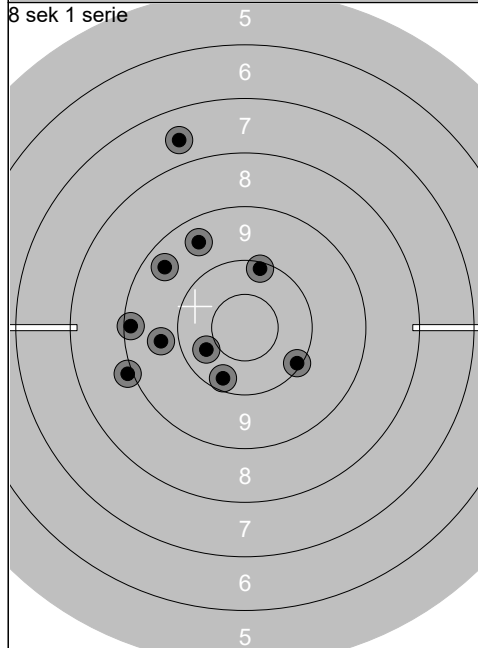

2.25s	9.5	↖
3.43s	9.2	↙
4.66s	7.6	↗
6.24s	10.1	↘
7.14s	9.4	↖
2.49s	10.4	↙
3.73s	9.7	↙
4.79s	9.0	↙
5.85s	10.1	↗
6.91s	10.2	↘
<b>Serie</b>	<b>92 ( 0x)</b>	
<b>Total</b>	<b>278 ( 3x)</b>	

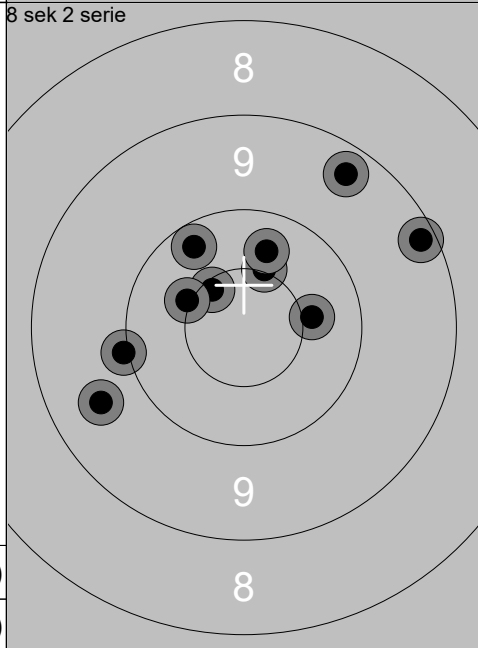

2.71s	9.4	↗
3.76s	10.0	↙
4.82s	10.2	↖
5.73s	10.5x	↗
6.63s	9.2	↗
2.68s	10.6x	↖
3.72s	10.5x	↙
4.86s	10.4x	→
5.72s	9.6	↙
6.91s	10.3	↗
<b>Serie</b>	<b>97 ( 4x)</b>	
<b>Total</b>	<b>375 ( 7x)</b>	

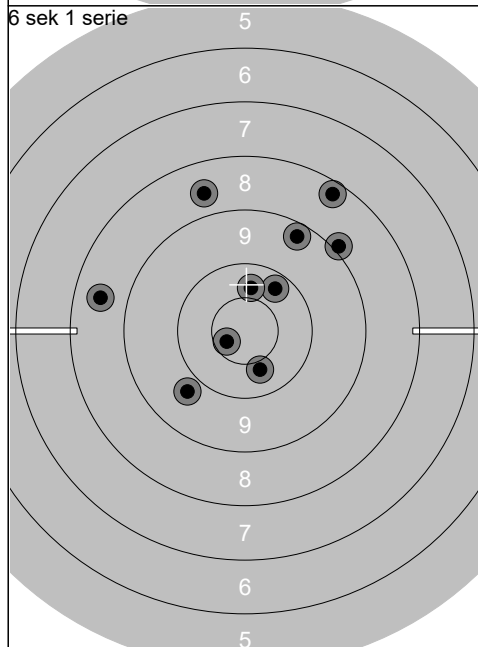

2.04s	10.4	↘
2.79s	8.6	↙
3.54s	10.2	↗
4.37s	8.6	↗
5.40s	9.8	↘
2.15s	8.3	↗
3.05s	10.4	↗
3.91s	10.7x	↙
4.62s	9.3	↗
5.39s	9.0	↗
<b>Serie</b>	<b>91 ( 1x)</b>	
<b>Total</b>	<b>466 ( 8x)</b>	

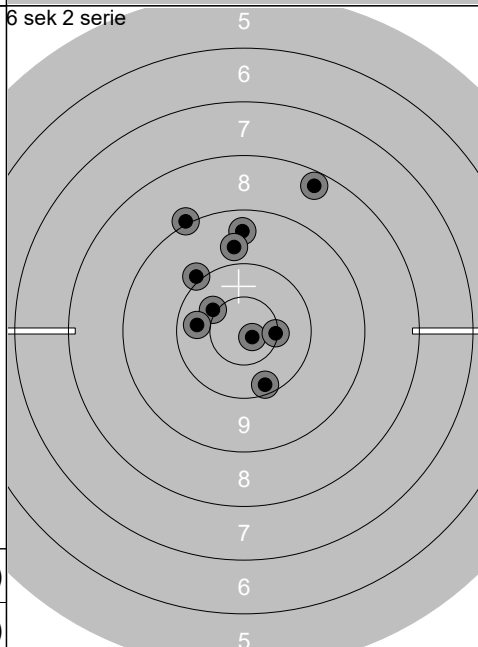

2.06s	9.5	↗
3.15s	10.4x	↖
4.04s	9.8	↗
4.79s	10.0	↖
5.56s	9.0	↖
2.27s	8.3	↗
3.19s	10.3	↙
3.96s	10.8x	↘
4.76s	10.2	↘
5.63s	10.5x	→
<b>Serie</b>	<b>95 ( 3x)</b>	
<b>Total</b>	<b>561 (11x)</b>	

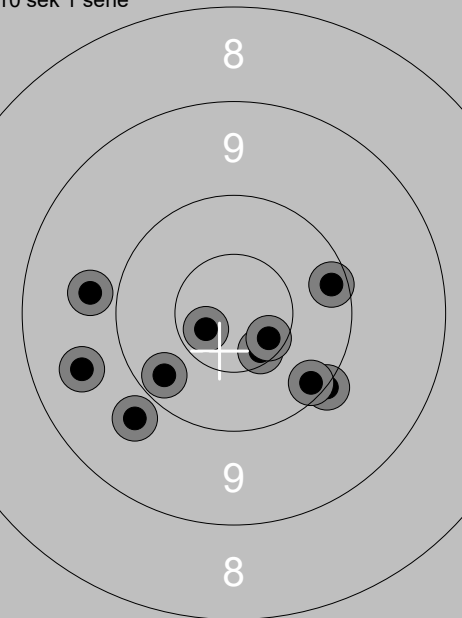
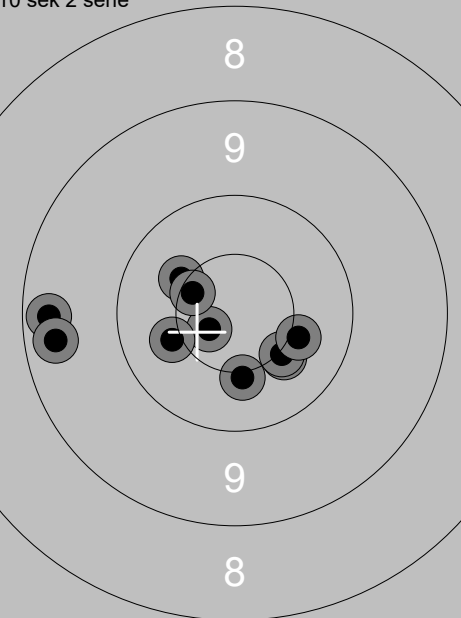
<p>10 sek 1 serie</p> 	<p>2.54s 10.0 ↘ 3.87s 10.6x ↘ 5.40s 9.8 ↙ 6.88s 10.6x ↘ 8.34s 10.1 ↘ 2.63s 10.2 → 3.92s 10.2 ↙ 5.50s 10.7x ↙ 6.78s 9.6 ← 8.27s 9.8 ←</p> <p>Serie 97 ( 3x) Total 97 ( 3x)</p>	<p>10 sek 2 serie</p> 	<p>2.48s 10.4x ↘ 3.84s 10.7x ↙ 5.31s 9.3 ← 6.64s 10.4x ↙ 7.79s 10.5x ↘ 2.68s 10.4x ↓ 3.94s 9.4 ← 5.32s 10.5x ↖ 6.57s 10.6x ↖ 7.84s 10.4x →</p> <p>Serie 98 ( 8x) Total 195 (11x)</p>
--	---	--	--

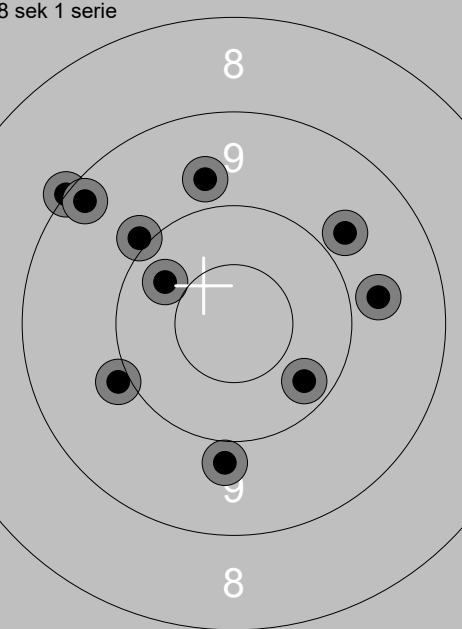
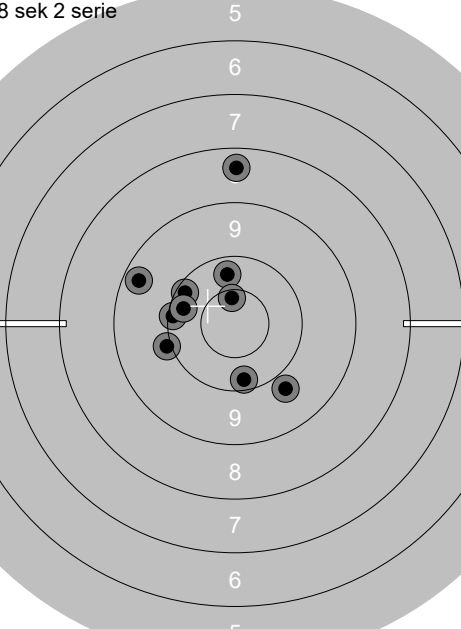
<p>8 sek 1 serie</p> 	<p>2.49s 9.1 ↖ 3.40s 10.2 ↘ 4.57s 9.3 ↗ 6.21s 10.0 ↗ 7.45s 9.8 ↑ 2.47s 9.8 ↓ 3.73s 10.3 ↖ 5.11s 9.9 ← 6.13s 9.8 ↗ 7.15s 9.8 →</p> <p>Serie 93 ( 0x) Total 288 (11x)</p>	<p>8 sek 2 serie</p> 	<p>2.45s 10.1 ← 3.48s 10.2 ↖ 4.58s 10.3 ↑ 5.64s 9.4 ↖ 6.69s 8.4 ↑ 2.36s 9.8 ↘ 3.64s 10.2 ↓ 4.83s 10.2 ← 5.93s 10.6x ↑ 7.10s 10.0 ←</p> <p>Serie 96 ( 1x) Total 384 (12x)</p>
--	---	--	--

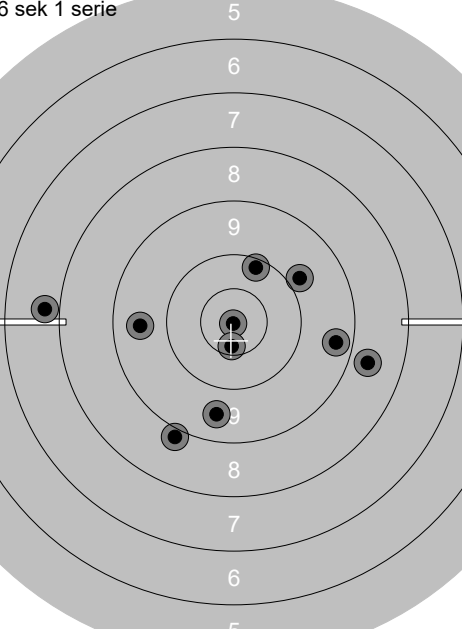
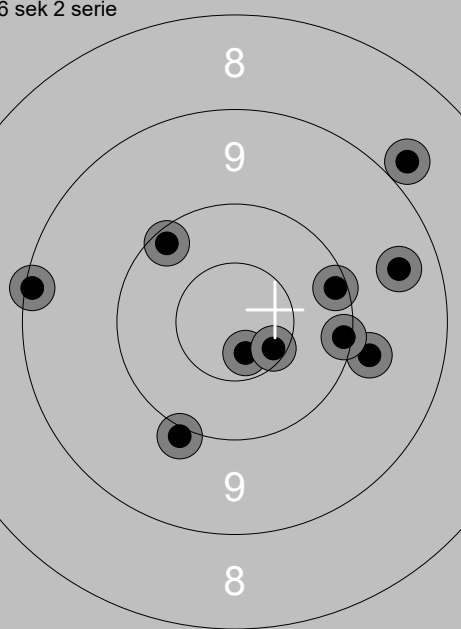
<p>6 sek 1 serie</p> 	<p>2.31s 9.6 ← 3.27s 8.7 → 4.18s 9.9 ↗ 5.15s 10.9x ↘ 6.11s 7.8 ← 2.06s 9.6 ↓ 2.88s 8.9 ↘ 3.82s 10.2 ↗ 4.59s 10.6x ↘ 5.49s 9.4 →</p> <p>Serie 89 ( 2x) Total 473 (14x)</p>	<p>6 sek 2 serie</p> 	<p>2.17s 9.5 → 3.06s 10.1 → 3.95s 9.8 → 4.86s 10.1 ↖ 5.94s 8.8 ↗ 2.06s 10.1 → 3.15s 9.1 ← 4.00s 10.7x ↓ 4.74s 10.6x ↘ 5.68s 10.0 ↓</p> <p>Serie 95 ( 2x) Total 568 (16x)</p>
---	---	---	--

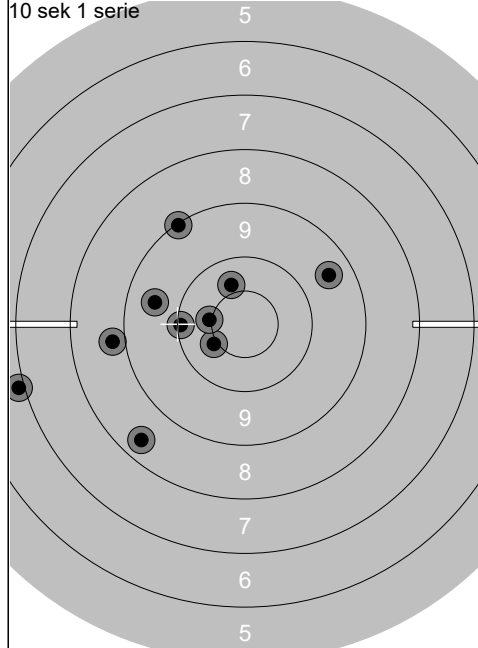

2.80s	10.4	↗
3.99s	8.4	↘
4.99s	10.5x	↙
6.12s	9.1	↗
7.75s	8.8	←
3.01s	10.5x	↙
3.99s	9.6	←
4.80s	7.0	←
5.80s	10.1	←
6.67s	9.5	↗
<b>Serie</b>	<b>90 ( 2x)</b>	
<b>Total</b>	<b>90 ( 2x)</b>	

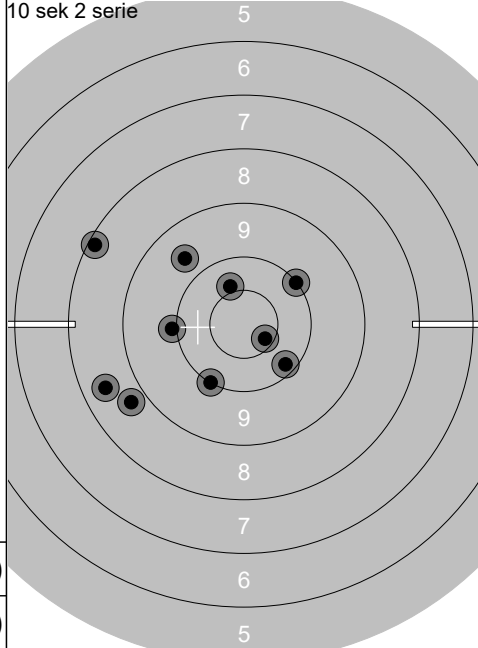

2.52s	10.4x	↖
3.78s	8.8	↘
4.88s	10.0	←
6.43s	10.0	↗
7.75s	8.2	↖
2.68s	10.6x	↘
3.65s	10.2	↘
4.57s	8.5	←
5.53s	9.7	↗
6.49s	10.0	↘
<b>Serie</b>	<b>93 ( 2x)</b>	
<b>Total</b>	<b>183 ( 4x)</b>	

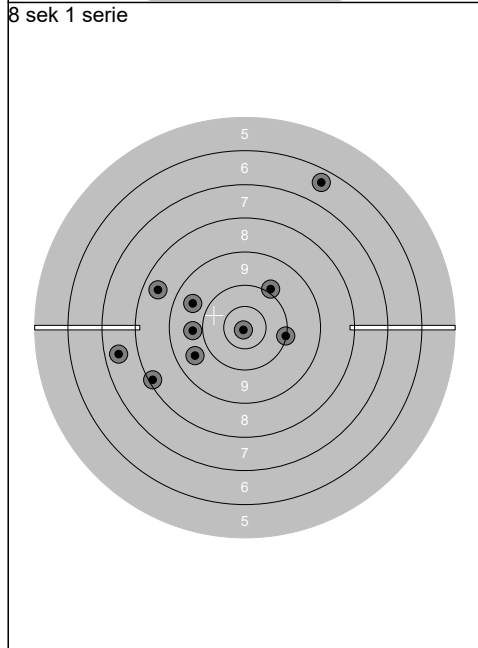

2.73s	8.2	↖
3.47s	7.5	←
4.34s	10.0	→
5.54s	9.6	↖
6.64s	9.8	←
2.50s	10.9x	↘
3.80s	9.9	↗
4.79s	8.5	↖
6.00s	6.4	↗
7.16s	9.6	↖
<b>Serie</b>	<b>85 ( 1x)</b>	
<b>Total</b>	<b>268 ( 5x)</b>	

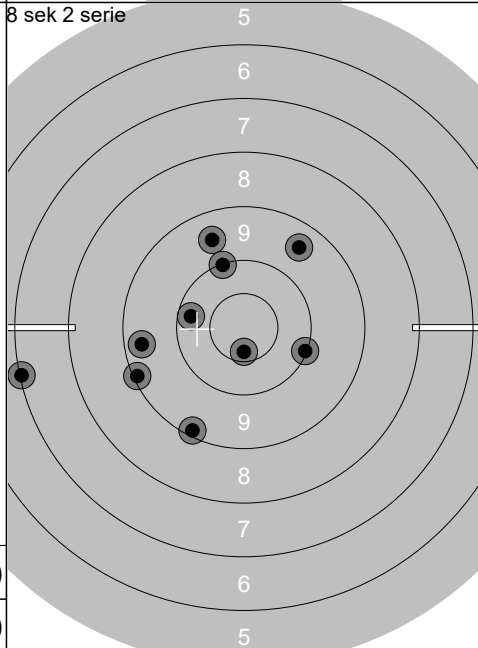

2.68s	9.6	↗
4.05s	7.1	←
5.05s	9.2	↘
5.96s	9.1	←
6.79s	9.4	←
2.70s	9.5	↗
3.61s	10.1	→
4.46s	10.2	←
5.36s	10.6x	↘
6.21s	10.1	↗
<b>Serie</b>	<b>92 ( 1x)</b>	
<b>Total</b>	<b>360 ( 6x)</b>	

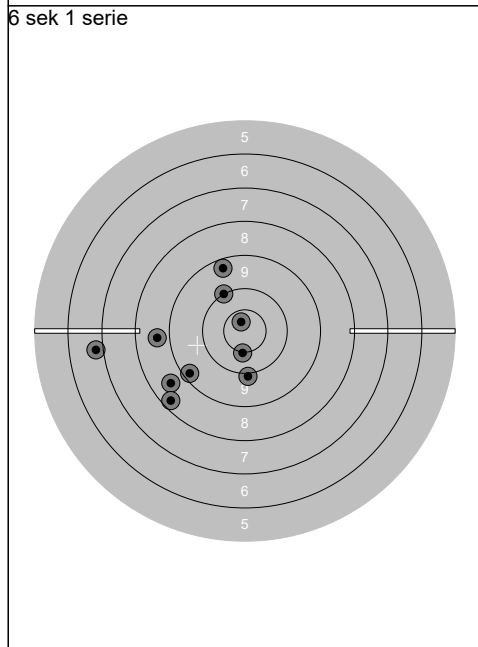

2.10s	9.3	↗
3.16s	8.6	↖
3.88s	10.0	↖
4.43s	9.2	↖
5.05s	8.3	↖
2.48s	10.7x	↖
3.30s	6.9	←
4.15s	10.0	↘
4.74s	8.7	←
5.79s	10.5x	↘
<b>Serie</b>	<b>88 ( 2x)</b>	
<b>Total</b>	<b>448 ( 8x)</b>	

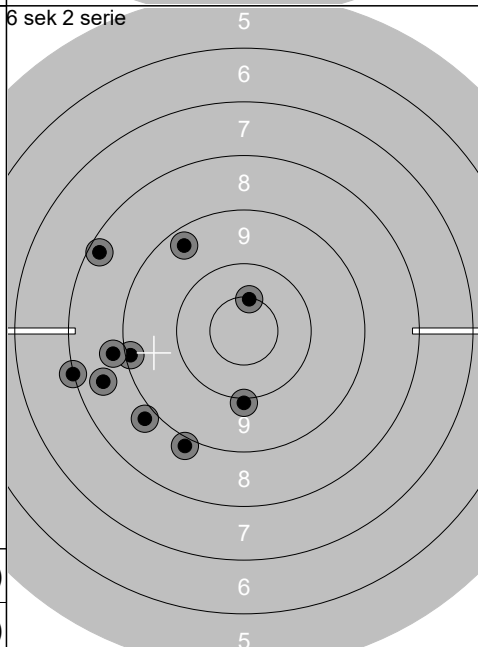

2.16s	10.0	↘
3.08s	8.9	↘
3.73s	8.9	↖
4.42s	8.6	←
5.21s	9.2	←
2.15s	8.3	↖
3.15s	9.4	↖
3.72s	10.5x	↗
4.46s	8.1	←
5.22s	8.9	←
<b>Serie</b>	<b>86 ( 1x)</b>	
<b>Total</b>	<b>534 ( 9x)</b>	

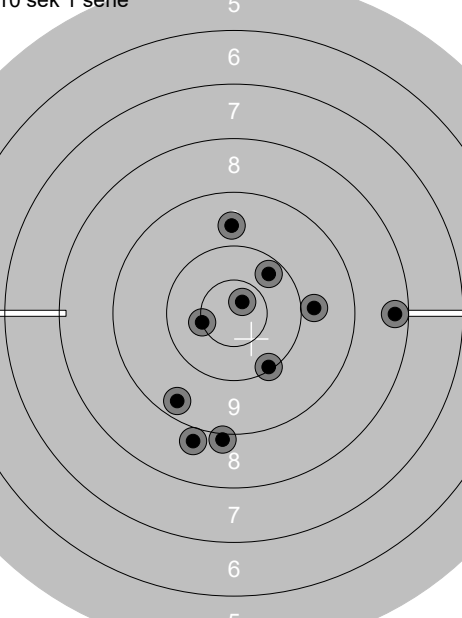
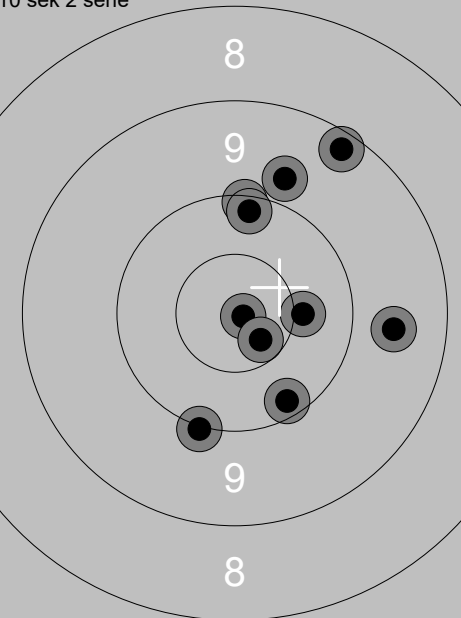
<p>10 sek 1 serie</p> 	<p>2.67s 9.8 →</p> <p>3.71s 10.2 ↗</p> <p>4.76s 10.1 ↘</p> <p>5.76s 9.4 ↘</p> <p>6.70s 8.3 →</p> <p>3.15s 10.8x ↗</p> <p>4.58s 9.7 ↑</p> <p>5.71s 8.8 ↘</p> <p>6.66s 10.5x ←</p> <p>7.60s 9.0 ↘</p> <p><b>Serie 92 ( 2x)</b></p> <p><b>Total 92 ( 2x)</b></p>	<p>10 sek 2 serie</p> 	<p>2.77s 10.1 ↑</p> <p>3.99s 10.0 ↓</p> <p>4.95s 10.2 ↘</p> <p>5.95s 10.9x →</p> <p>6.86s 10.7x ↘</p> <p>2.85s 9.2 ↗</p> <p>4.20s 9.8 ↑</p> <p>5.27s 10.4x →</p> <p>6.26s 10.2 ↑</p> <p>7.24s 9.6 →</p> <p><b>Serie 97 ( 3x)</b></p> <p><b>Total 189 ( 5x)</b></p>
--	---	--	--

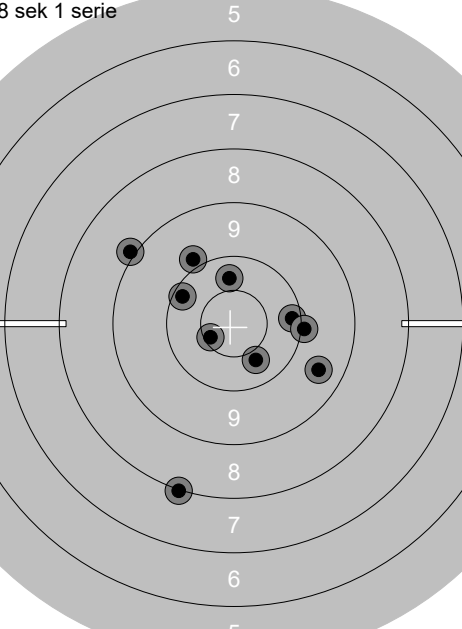
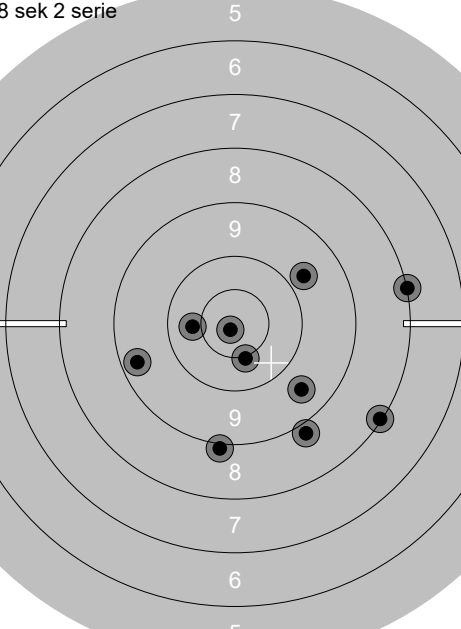
<p>8 sek 1 serie</p> 	<p>2.96s 9.0 ↖</p> <p>3.84s 9.5 ↘</p> <p>4.73s 10.2 →</p> <p>5.58s 10.6x ←</p> <p>6.35s 8.1 ↘</p> <p>2.54s 9.9 ↗</p> <p>3.54s 10.0 →</p> <p>4.45s 10.2 ↖</p> <p>5.37s 10.3 ↑</p> <p>6.19s 10.4 ↘</p> <p><b>Serie 95 ( 1x)</b></p> <p><b>Total 284 ( 6x)</b></p>	<p>8 sek 2 serie</p> 	<p>2.78s 8.9 ↘</p> <p>3.77s 8.1 →</p> <p>4.65s 8.1 ↘</p> <p>5.53s 9.8 ↗</p> <p>6.49s 9.6 ↘</p> <p>2.39s 10.4 ←</p> <p>3.70s 10.8x ↘</p> <p>4.72s 9.0 ↘</p> <p>5.62s 10.5x ↘</p> <p>6.71s 9.4 ←</p> <p><b>Serie 90 ( 2x)</b></p> <p><b>Total 374 ( 8x)</b></p>
--	---	--	---

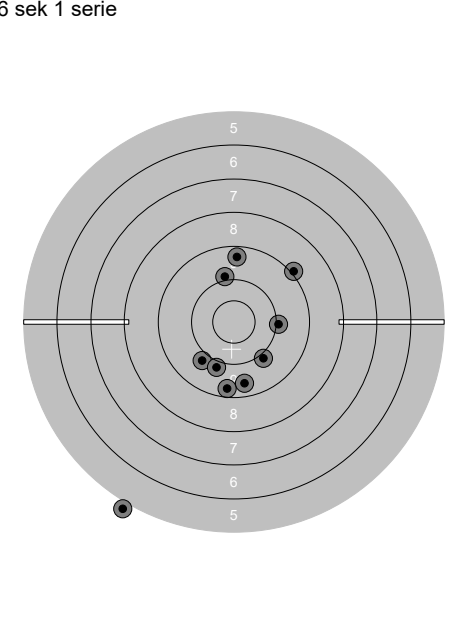
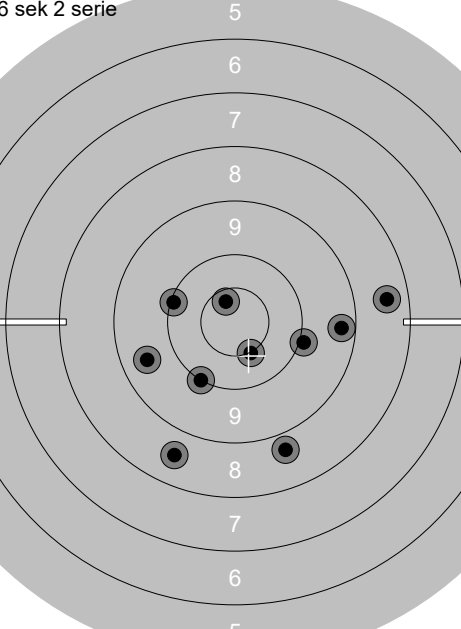
<p>6 sek 1 serie</p> 	<p>2.10s 10.0 ↑</p> <p>3.05s 9.4 ↑</p> <p>3.87s 9.8 ↘</p> <p>4.51s 0.0 ↘</p> <p>5.11s 9.3 ↘</p> <p>1.97s 9.0 ↗</p> <p>2.60s 10.0 →</p> <p>3.24s 9.5 ↘</p> <p>3.95s 9.9 ↘</p> <p>4.51s 9.9 ↘</p> <p><b>Serie 83 ( 0x)</b></p> <p><b>Total 457 ( 8x)</b></p>	<p>6 sek 2 serie</p> 	<p>2.18s 9.3 →</p> <p>2.92s 9.6 ←</p> <p>3.62s 10.6x ↗</p> <p>4.30s 10.0 →</p> <p>5.19s 8.8 ↘</p> <p>2.00s 8.5 →</p> <p>2.89s 10.5x ↘</p> <p>3.59s 10.0 ↘</p> <p>4.30s 10.1 ←</p> <p>4.96s 8.6 ↘</p> <p><b>Serie 92 ( 2x)</b></p> <p><b>Total 549 ( 10x)</b></p>
---	--	---	--

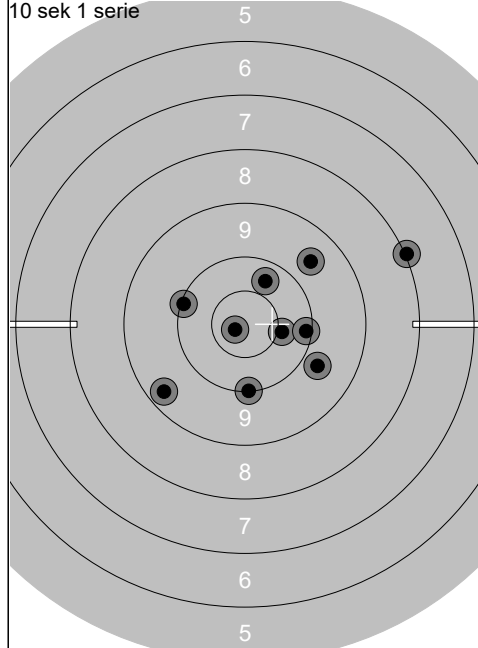

2.86s	10.1	↔
4.09s	9.4	↙
5.25s	10.4x	→
6.58s	10.1	→
7.73s	10.0	↓
2.33s	9.6	↗
3.82s	8.0	↗
4.95s	10.3	↗
6.08s	9.8	↘
7.32s	10.8x	↙
<b>Serie</b>		<b>95 ( 2x)</b>
<b>Total</b>		<b>95 ( 2x)</b>

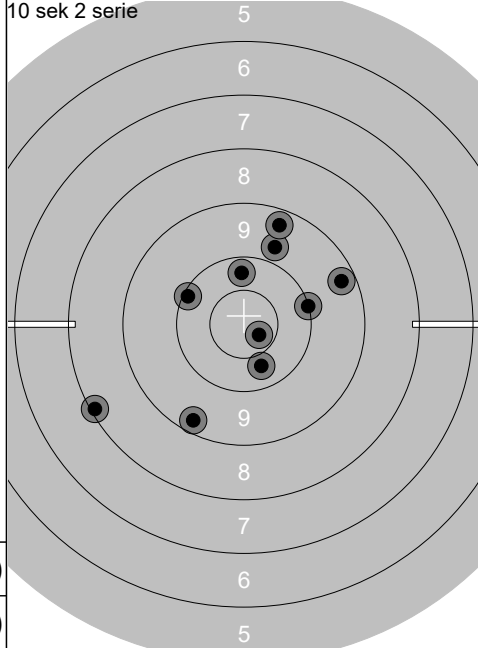

2.45s	10.1	↔
3.60s	9.3	↗
4.79s	9.8	↗
5.86s	9.3	↓
7.70s	8.1	↙
2.64s	9.4	↗
3.82s	10.7x	↘
5.01s	10.0	→
6.27s	10.2	↑
7.96s	10.3	↓
<b>Serie</b>		<b>94 ( 1x)</b>
<b>Total</b>		<b>189 ( 3x)</b>

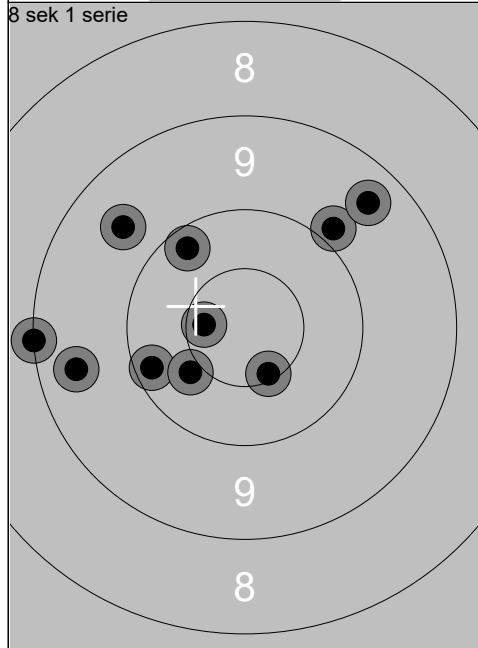

2.49s	9.6	↙
3.42s	10.2	↙
4.42s	9.9	↗
5.39s	10.5x	↘
6.72s	9.1	↙
1.89s	9.5	↙
2.96s	10.6x	↙
4.08s	9.5	↗
5.40s	10.4x	↙
6.66s	10.2	↙
<b>Serie</b>		<b>95 ( 3x)</b>
<b>Total</b>		<b>284 ( 6x)</b>

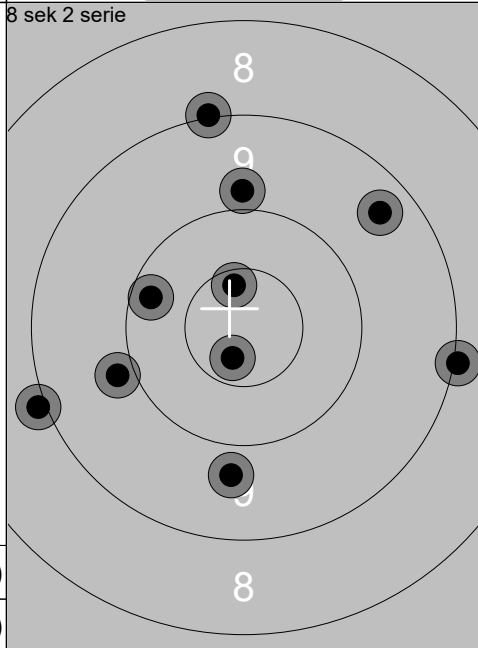

2.14s	10.7x	↘
3.23s	9.4	↗
4.17s	10.2	↙
5.21s	9.0	→
6.60s	10.6x	↗
2.36s	9.9	↙
3.48s	9.0	↑
4.62s	9.9	↑
5.76s	9.8	↓
7.06s	9.0	↙
<b>Serie</b>		<b>93 ( 2x)</b>
<b>Total</b>		<b>377 ( 8x)</b>

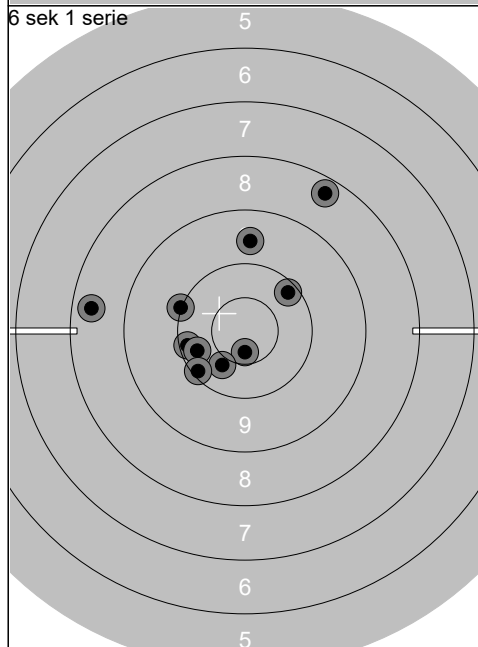

2.00s	10.2	↗
2.67s	8.4	↗
3.55s	10.1	↙
4.38s	9.7	↑
5.42s	10.0	↙
1.94s	10.2	↙
2.71s	10.7x	↘
3.51s	10.4	↘
4.47s	10.1	↙
5.56s	8.4	↙
<b>Serie</b>		<b>95 ( 1x)</b>
<b>Total</b>		<b>472 ( 9x)</b>

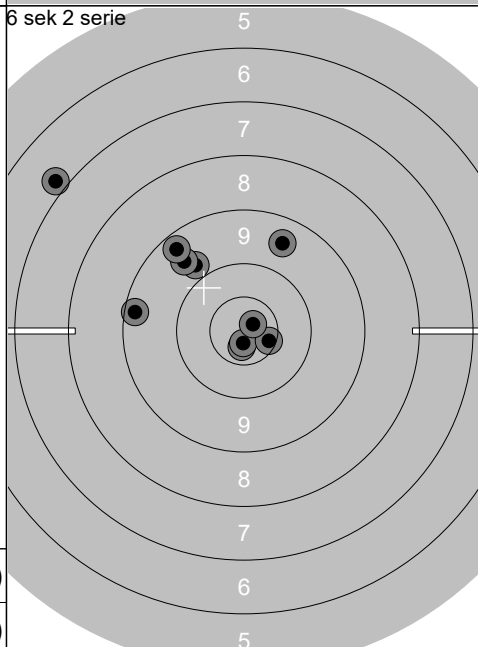

1.91s	6.9	↙
2.72s	9.8	↙
3.63s	9.6	↗
4.46s	9.4	↙
5.42s	9.5	↗
2.29s	10.7x	↘
3.29s	10.8x	↘
4.00s	10.6x	↘
4.83s	10.8x	↗
5.78s	9.3	↙
<b>Serie</b>		<b>91 ( 4x)</b>
<b>Total</b>		<b>563 (13x)</b>

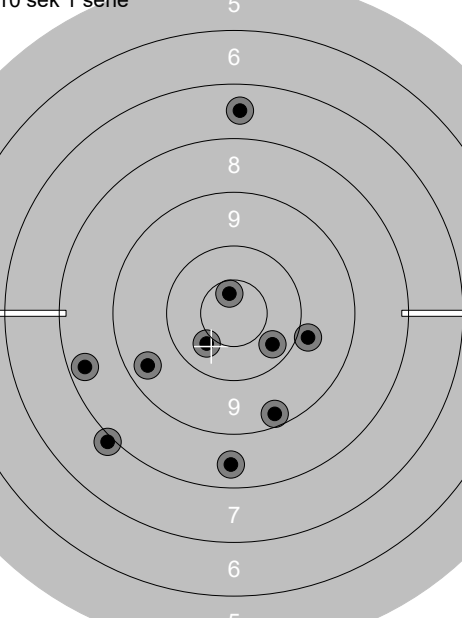
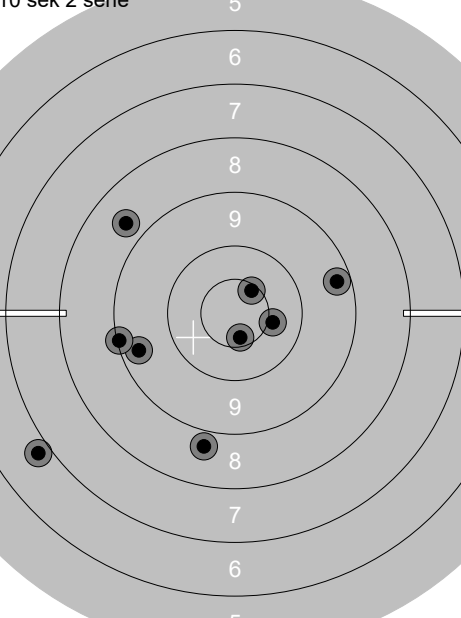

<p>10 sek 1 serie</p> 	<p>2.77s 8.0 ↙ 3.81s 10.4 ↙ 4.80s 10.3 ↘ 5.80s 9.5 ← 6.71s 9.3 ↓ 2.81s 7.6 ↑ 3.96s 9.9 → 5.07s 8.5 ↓ 6.39s 10.7x ↑ 7.83s 8.4 ←</p> <p><b>Serie 88 ( 1x)</b></p> <p><b>Total 88 ( 1x)</b></p>	<p>10 sek 2 serie</p> 	<p>2.50s 9.3 → 3.47s 10.4x → 4.38s 10.6x ↗ 5.53s 8.7 ↖ 6.53s 8.8 ↓ 2.93s 9.4 ← 4.48s ☒ 6.14s 9.1 ← 7.37s 10.6x ↓ 8.68s 6.9 ←</p> <p><b>Serie 79 ( 3x)</b></p> <p><b>Total 167 ( 4x)</b></p>
--	--	--	---

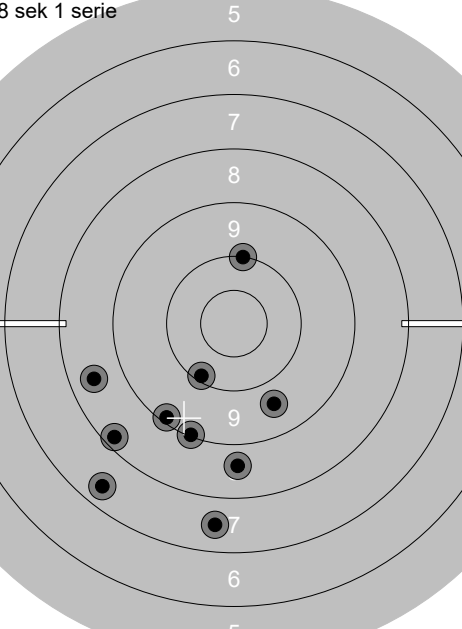
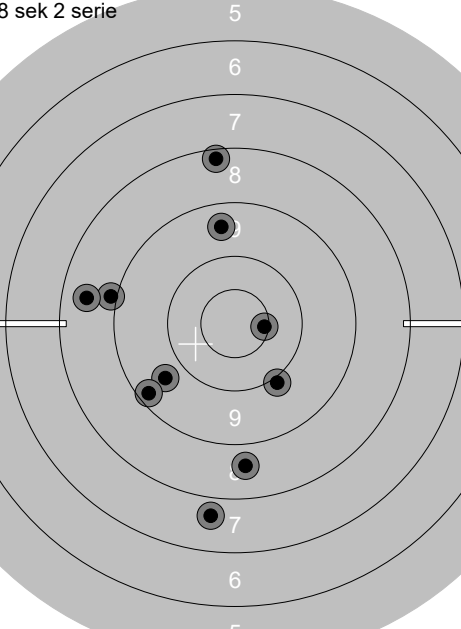
<p>8 sek 1 serie</p> 	<p>2.87s 9.1 ↓ 3.79s 8.3 ↙ 4.61s 9.2 ↙ 5.57s 7.6 ↓ 6.62s 8.7 ↓ 2.70s 10.1 ↙ 3.66s 7.4 ↙ 4.65s 10.0 ↑ 5.89s 9.7 ↓ 6.95s 8.5 ←</p> <p><b>Serie 85 ( 0x)</b></p> <p><b>Total 252 ( 4x)</b></p>	<p>8 sek 2 serie</p> 	<p>2.42s 8.2 ↑ 3.54s 9.5 ↑ 4.46s 10.0 ↓ 5.47s 9.7 ↙ 6.47s 9.0 ← 2.45s 10.6x → 3.48s 8.7 ↓ 4.53s 7.7 ↓ 5.55s 8.5 ← 6.48s 9.3 ↙</p> <p><b>Serie 87 ( 1x)</b></p> <p><b>Total 339 ( 5x)</b></p>
--	---	--	--

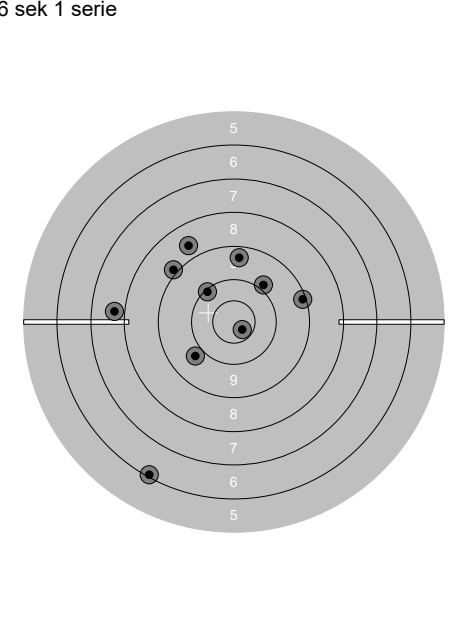
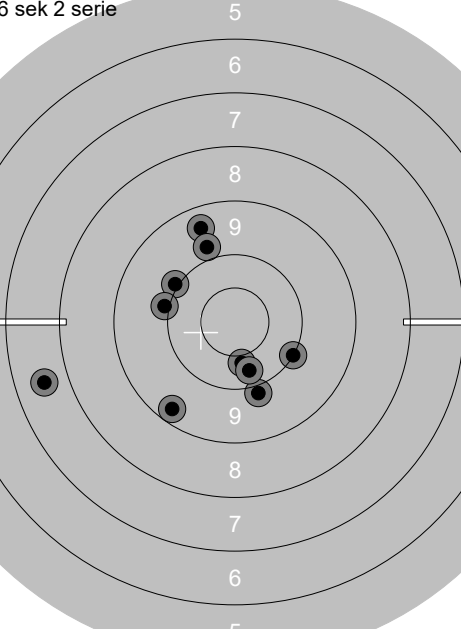
<p>6 sek 1 serie</p> 	<p>2.13s 8.9 ↖ 2.87s 8.7 ↖ 3.59s 9.4 ↑ 4.34s 9.9 ↗ 5.14s 9.8 ↙ 2.21s 6.1 ↓ 3.15s 7.8 ← 3.85s 9.2 → 4.65s 10.1 ↖ 5.52s 10.7x ↘</p> <p><b>Serie 85 ( 1x)</b></p> <p><b>Total 424 ( 6x)</b></p>	<p>6 sek 2 serie</p> 	<p>2.18s 10.0 ↘ 3.18s 10.0 ↖ 4.08s 9.5 ↑ 4.98s 9.9 ↓ 5.86s 10.4 ↓ 2.35s 9.3 ↙ 3.19s 10.3 ↓ 3.87s 10.0 ← 4.90s 9.8 ↑ 5.80s 7.6 ←</p> <p><b>Serie 93 ( 0x)</b></p> <p><b>Total 517 ( 6x)</b></p>
---	--	---	--

<p>10 sek 1 serie</p>	<p>3.11s 10.9x ↗ 4.34s 10.2 → 5.50s 10.6x ↙ 6.88s 10.6x ↖ 8.09s 10.2 ↘ 2.47s 10.3 ↘ 3.54s 9.8 → 4.55s 10.3 ↗ 6.11s 10.2 ← 7.52s 10.8x ↓</p> <p>Serie 99 ( 4x) Total 99 ( 4x)</p>	<p>10 sek 2 serie</p>	<p>2.71s 10.4x ↑ 3.81s 9.6 ↓ 5.14s 10.4x ↓ 6.40s 10.1 ↘ 7.60s 9.5 ↙ 2.80s 9.8 ↗ 3.90s 9.3 → 4.97s 10.7x ↘ 6.24s 9.7 ↑ 7.50s 9.6 ↗</p> <p>Serie 94 ( 3x) Total 193 ( 7x)</p>
-----------------------	--	-----------------------	---

<p>8 sek 1 serie</p>	<p>2.45s 10.4 ↖ 3.43s 9.5 ↘ 4.47s 8.4 ↘ 5.87s 10.5x → 7.15s 10.2 ↘ 2.56s 8.7 ↗ 3.63s 9.1 → 4.80s 9.9 → 5.87s 10.8x ↓ 7.06s 9.7 ←</p> <p>Serie 92 ( 2x) Total 285 ( 9x)</p>	<p>8 sek 2 serie</p>	<p>2.23s 10.3 ↖ 3.62s 10.2 ↑ 4.84s 8.6 ← 5.83s 10.0 ↙ 6.81s 10.0 ↘ 2.77s 9.7 → 3.96s 9.3 ↙ 5.29s 10.3 ↑ 6.36s 9.7 ↙ 7.43s 10.8x ↖</p> <p>Serie 95 ( 1x) Total 380 ( 10x)</p>
----------------------	--	----------------------	--

<p>6 sek 1 serie</p>	<p>2.00s 10.4x ↗ 2.74s 10.1 ↘ 3.58s 9.0 ↑ 4.88s 10.5x ↑ 5.51s 8.3 ← 2.12s 10.0 ↑ 3.11s 8.7 ← 4.16s 8.4 ↗ 4.97s 10.7x ↘ 5.67s 9.4 ↘</p> <p>Serie 92 ( 3x) Total 472 ( 13x)</p>	<p>6 sek 2 serie</p>	<p>2.52s 10.0 ↑ 3.38s 10.7x ↙ 4.05s 10.1 ← 4.76s 10.1 ↓ 5.58s 10.4 → 2.06s 10.0 ↑ 3.05s 9.8 ↙ 4.03s 9.4 ↖ 4.74s 10.2 → 5.54s 9.5 ↓</p> <p>Serie 97 ( 1x) Total 569 ( 14x)</p>
----------------------	---	----------------------	---

Lag	Skive	Tord Esten Murbreck	
2	32		
Hurtigpistol Grov		Hamar SSK	
25.06.2019		NM bane 2019	
		NM Pistol 2019	
10 sek 1 serie		3.00s 8.5 ↘ 4.30s 9.9 ↙ 5.71s 10.4x↙ 6.85s 10.1 → 8.13s 10.4 ↓ 3.47s 9.8 ↓ 5.05s 10.2 ↗ 6.32s 10.5x↙ 7.58s 9.7 → 8.76s 9.5 ↗ Serie 94 ( 2x) Total 94 ( 2x)	10 sek 2 serie  3.87s 9.6 ↓ 4.88s 9.1 ↗ 6.27s 9.5 ↓ 7.49s 9.7 ← 8.72s 10.2 ↓ 3.19s 8.9 ← 4.42s 9.7 ↗ 5.64s 10.0 ↑ 7.08s 10.5x↙ 8.39s 10.3 → Serie 93 ( 1x) Total 187 ( 3x)
8 sek 1 serie		2.88s 8.5 ↘ 3.95s 9.9 ↙ 4.97s 10.4 ↗ 5.88s 9.4 ← 6.86s 9.3 ↑ 3.03s 10.9x↙ 4.30s 10.6x↖ 5.50s 9.7 → 6.48s 10.5x↘ 7.62s 10.2 ↖ Serie 94 ( 3x) Total 281 ( 6x)	8 sek 2 serie  3.01s 10.7x↗ 4.21s 10.4x↗ 5.20s 8.6 ↗ 6.30s 10.2 ← 7.35s 10.1 ↗ 2.52s 10.1 ↑ 3.79s 9.9 ↑ 4.91s 9.2 ↗ 7.11s 0.0 ← 7.83s 9.1 ↗ Serie 85 ( 2x) Total 366 ( 8x)
6 sek 1 serie		2.35s 8.1 ← 3.20s 10.7x→ 3.90s 8.1 ↖ 4.74s 8.8 ← 5.49s 9.6 ↓ 2.08s 10.0 ↓ 2.83s 8.7 ↓ 3.66s 10.4 ↑ 4.38s 10.5x↙ 5.09s 10.3 ↑ Serie 91 ( 2x) Total 457 ( 10x)	6 sek 2 serie  2.21s 8.2 ↖ 2.95s 7.5 ↓ 3.64s 10.4 ← 4.38s 8.8 ← 5.13s 10.7x↓ 2.04s 10.0 ↗ 2.91s 9.6 ↗ 3.73s 8.8 ↗ 4.41s 9.9 ← 5.38s 10.7x↙ Serie 89 ( 2x) Total 546 ( 12x)

<p>10 sek 1 serie</p>	<p>2.80s 9.6 ↗</p> <p>3.94s 10.2 ↖</p> <p>5.36s 6.2 →</p> <p>6.51s 10.5x→</p> <p>7.50s 9.6 ↘</p> <p>2.90s 10.4 ↗</p> <p>3.98s 10.3 →</p> <p>4.80s 10.0 →</p> <p>5.58s 10.1 ↑</p> <p>6.61s 9.4 ↑</p> <p><b>Serie 93 ( 1x)</b></p> <p><b>Total 93 ( 1x)</b></p>	<p>10 sek 2 serie</p>	<p>2.78s 8.6 ↗</p> <p>3.67s 10.5x→</p> <p>4.59s 9.9 →</p> <p>5.69s 7.9 ↖</p> <p>6.51s 9.4 ↗</p> <p>2.54s 8.6 ↑</p> <p>3.68s 10.3 ↗</p> <p>4.55s 8.7 ↑</p> <p>5.31s 10.8x↖</p> <p>5.95s 10.1 →</p> <p><b>Serie 89 ( 2x)</b></p> <p><b>Total 182 ( 3x)</b></p>
<p>8 sek 1 serie</p>	<p>2.78s 7.9 ↗</p> <p>3.78s 10.3 ↗</p> <p>4.69s 8.5 ↑</p> <p>5.43s 10.2 ↘</p> <p>6.41s 9.8 ↖</p> <p>2.54s 9.0 ↖</p> <p>3.76s 8.5 ↑</p> <p>4.67s 9.7 ↗</p> <p>5.58s 8.5 →</p> <p>6.28s 10.3 ↘</p> <p><b>Serie 88 ( 0x)</b></p> <p><b>Total 270 ( 3x)</b></p>	<p>8 sek 2 serie</p>	<p>2.96s 9.1 ↘</p> <p>3.83s 9.0 ↘</p> <p>4.74s 10.3 ↘</p> <p>5.57s 10.2 ↗</p> <p>6.43s 10.0 ↖</p> <p>2.50s 8.7 →</p> <p>3.66s 10.3 ↘</p> <p>4.51s 8.4 ↑</p> <p>5.38s 9.9 ↗</p> <p>6.24s 9.9 ↑</p> <p><b>Serie 92 ( 0x)</b></p> <p><b>Total 362 ( 3x)</b></p>
<p>6 sek 1 serie</p>	<p>2.29s 10.2 ↘</p> <p>3.21s 10.4x↖</p> <p>3.99s 10.2 ↘</p> <p>4.76s 10.5x↖</p> <p>5.44s 9.3 ↗</p> <p>2.40s 9.9 ↖</p> <p>3.16s 10.1 ↗</p> <p>3.88s 10.1 ↖</p> <p>4.67s 9.6 ↖</p> <p>5.31s 8.7 ↘</p> <p><b>Serie 95 ( 2x)</b></p> <p><b>Total 457 ( 5x)</b></p>	<p>6 sek 2 serie</p>	<p>2.38s 10.0 ↗</p> <p>3.18s 10.3 ↖</p> <p>3.83s 9.0 ↘</p> <p>4.51s 10.5x↑</p> <p>5.30s 10.4x↖</p> <p>2.40s 8.6 ↖</p> <p>3.15s 9.4 ↘</p> <p>3.93s 10.0 ↖</p> <p>4.65s 10.2 ↖</p> <p>5.27s 9.0 ↑</p> <p><b>Serie 95 ( 2x)</b></p> <p><b>Total 552 ( 7x)</b></p>

Lag	Skive	Anders Jonassen Hernes	
2	34	Ørland Pk	Å
25.06.2019		NM bane 2019	NM Pistol 2019
10 sek 1 serie		3.15s 7.1 ↙ 4.83s 8.2 ↑ 6.19s 10.5x ↑ 7.54s 9.9 ↖ 8.89s 10.6x ↗ 3.01s 9.1 ↓ 4.53s 10.2 ↓ 5.64s 9.5 ↘ 6.81s 10.1 → 7.93s 10.0 ↓ <b>Serie 92 ( 2x)</b> <b>Total 92 ( 2x)</b>	10 sek 2 serie  2.63s 9.5 ↘ 3.88s 10.6x ↑ 5.16s 9.1 ↗ 6.57s 10.4 ← 7.82s 10.5x ↙ 2.86s 9.2 ↑ 4.34s 10.5x ↑ 5.40s 10.2 ← 6.39s 9.5 ← 7.50s 9.4 → <b>Serie 95 ( 3x)</b> <b>Total 187 ( 5x)</b>
8 sek 1 serie		2.43s 8.6 ↓ 3.47s 9.5 ↓ 4.49s 10.5x ↖ 5.55s 8.3 ↑ 6.47s 8.6 ← 2.43s 9.0 ↓ 4.00s 8.9 ↗ 5.21s 9.7 ← 6.15s 9.9 → 7.26s 9.7 ↓ <b>Serie 87 ( 1x)</b> <b>Total 274 ( 6x)</b>	8 sek 2 serie  2.00s 7.0 ↓ 3.26s 9.9 ↓ 4.34s 10.5x ↑ 5.23s 7.1 ← 6.40s 7.6 ↓ 2.29s 8.0 ← 3.64s 9.8 → 4.75s 10.6x ↗ 5.69s 10.0 ↓ 6.72s 10.7x ↘ <b>Serie 87 ( 3x)</b> <b>Total 361 ( 9x)</b>
6 sek 1 serie		2.00s 10.0 → 3.13s 9.5 ↓ 4.01s 7.8 ← 4.92s 9.6 ← 5.84s 9.7 ← 1.93s 9.4 ← 2.93s 8.7 ← 3.95s 10.2 → 4.83s 9.3 → 5.75s 8.9 ↓ <b>Serie 88 ( 0x)</b> <b>Total 449 ( 9x)</b>	6 sek 2 serie  2.08s 6.3 ↙ 3.26s 8.6 ↓ 4.19s 10.2 ↖ 5.15s 9.7 ↙ 6.24s 10.0 ↓ 1.98s 10.8x ↗ 2.70s 10.2 ↑ 3.60s 9.3 ↓ 4.55s 10.4 ↘ 5.46s 10.6x → <b>Serie 92 ( 2x)</b> <b>Total 541 ( 11x)</b>

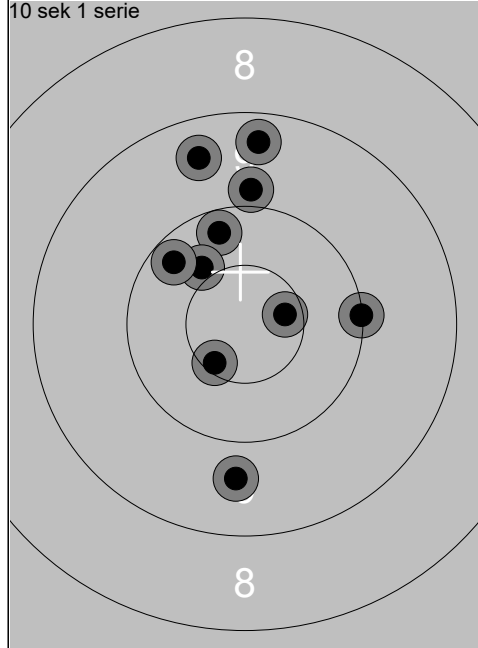

3.38s	10.2	↑
4.82s	9.9	↑
6.16s	10.4	↖
7.40s	10.6x	→
8.88s	10.2	↖
2.90s	10.0	→
5.16s	10.6x	↙
6.39s	9.4	↑
7.65s	9.5	↑
8.78s	9.7	↓
<b>Serie</b>	<b>96 ( 2x)</b>	
<b>Total</b>	<b>96 ( 2x)</b>	

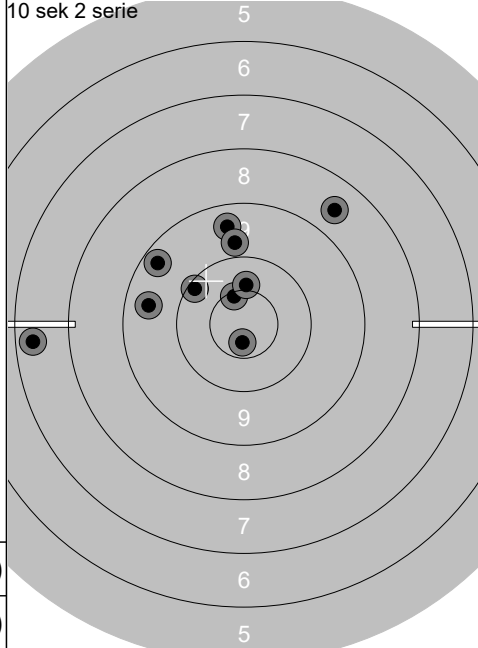

2.50s	9.4	↖
3.80s	10.1	↖
5.05s	9.5	←
6.61s	10.5x	↖
7.92s	9.5	↑
2.76s	10.7x	↓
3.94s	8.6	↗
5.15s	9.8	↑
6.49s	10.4x	↑
7.95s	7.4	←
<b>Serie</b>	<b>91 ( 3x)</b>	
<b>Total</b>	<b>187 ( 5x)</b>	

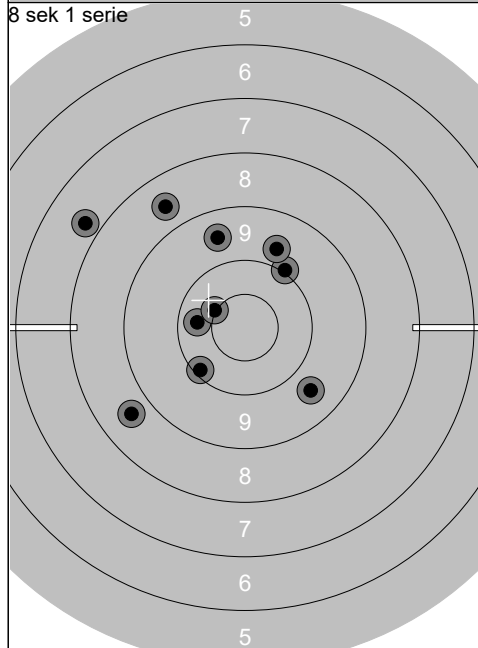

2.92s	8.6	↖
3.88s	10.0	↗
4.94s	10.1	↙
5.94s	8.7	↙
6.79s	10.3	←
2.59s	9.6	↑
3.85s	7.8	↖
5.03s	10.5x	↖
6.09s	9.6	↘
7.19s	9.7	↗
<b>Serie</b>	<b>90 ( 1x)</b>	
<b>Total</b>	<b>277 ( 6x)</b>	

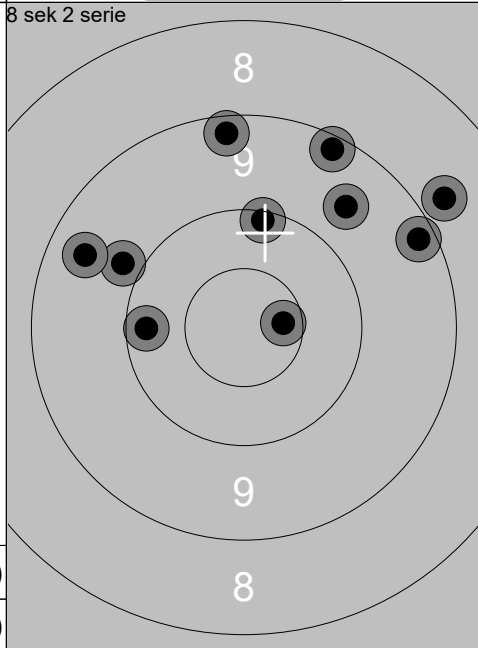

2.66s	9.2	↗
3.87s	10.2	←
4.94s	10.1	↑
6.08s	9.6	↗
7.25s	10.6x	→
2.97s	9.2	↗
4.01s	9.9	↖
5.12s	9.5	↖
6.17s	9.3	↑
7.51s	8.8	↗
<b>Serie</b>	<b>92 ( 1x)</b>	
<b>Total</b>	<b>369 ( 7x)</b>	

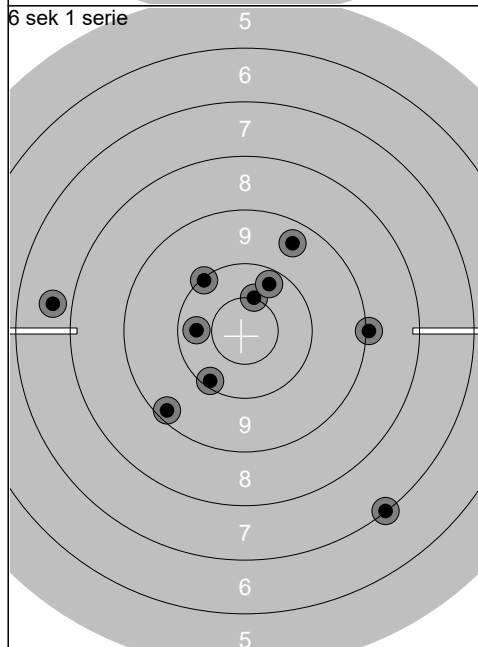

2.22s	7.7	←
3.18s	9.3	↙
4.03s	9.5	↗
4.84s	10.5x	↑
5.70s	7.1	↘
2.33s	9.0	→
3.20s	10.2	↗
4.07s	10.1	↙
5.01s	10.1	↖
5.76s	10.3	←
<b>Serie</b>	<b>91 ( 1x)</b>	
<b>Total</b>	<b>460 ( 8x)</b>	

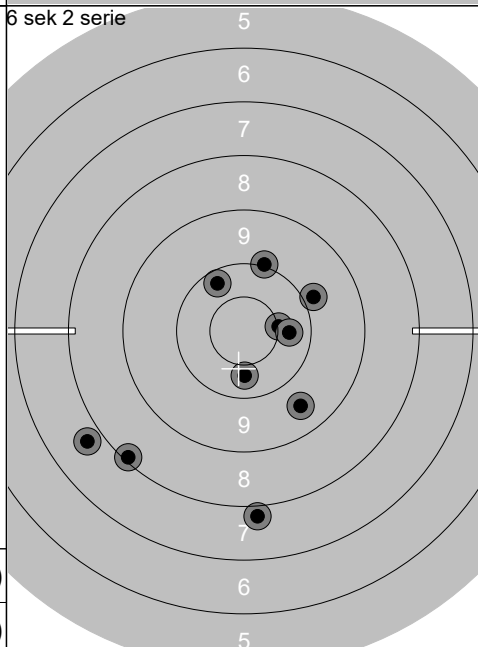

2.18s	10.5x	→
3.11s	10.3	→
4.01s	7.8	↙
4.84s	9.9	↗
5.65s	10.3	↓
2.29s	10.2	↖
3.08s	9.6	↘
3.89s	7.9	↓
4.73s	10.0	↗
5.50s	8.1	↙
<b>Serie</b>	<b>90 ( 1x)</b>	
<b>Total</b>	<b>550 ( 9x)</b>	

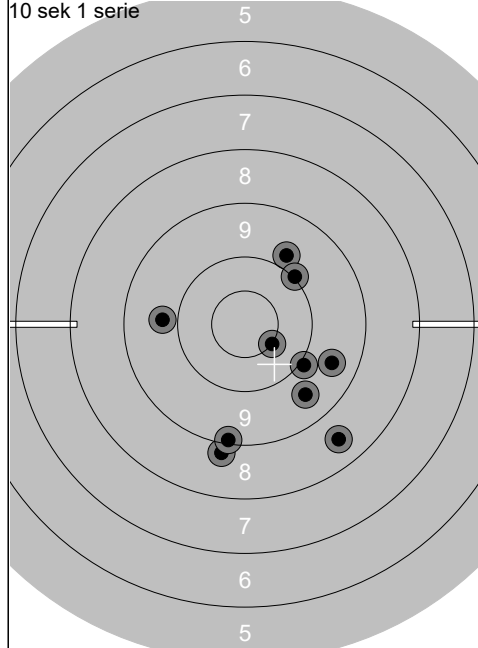

2.75s	9.8	←
4.58s	9.6	↘
5.62s	9.8	↗
6.70s	8.6	↘
7.91s	9.6	→
3.05s	8.9	↘
4.53s	9.2	↘
6.00s	10.0	↘
7.42s	10.0	↗
8.61s	10.5x	↘
<b>Serie</b>	<b>91 ( 1x)</b>	
<b>Total</b>	<b>91 ( 1x)</b>	

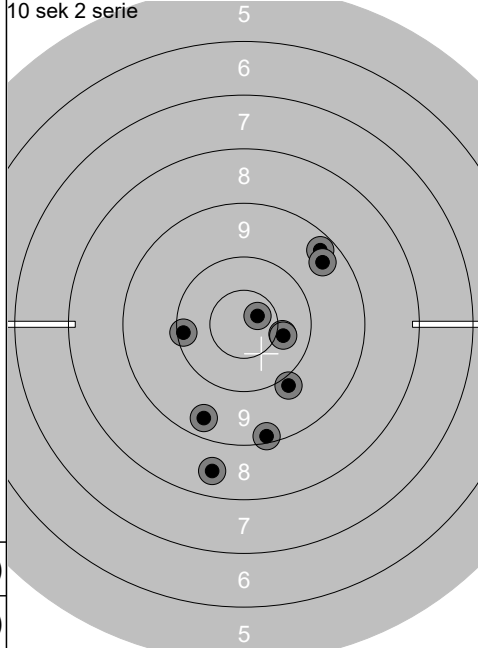

3.07s	9.3	↗
4.42s	10.4x	→
5.86s	9.4	↘
6.81s	8.5	↘
7.98s	10.7x	↗
2.94s	10.4	→
4.24s	10.1	←
5.45s	9.9	↘
6.67s	9.5	↗
8.01s	9.2	↘
<b>Serie</b>	<b>93 ( 2x)</b>	
<b>Total</b>	<b>184 ( 3x)</b>	

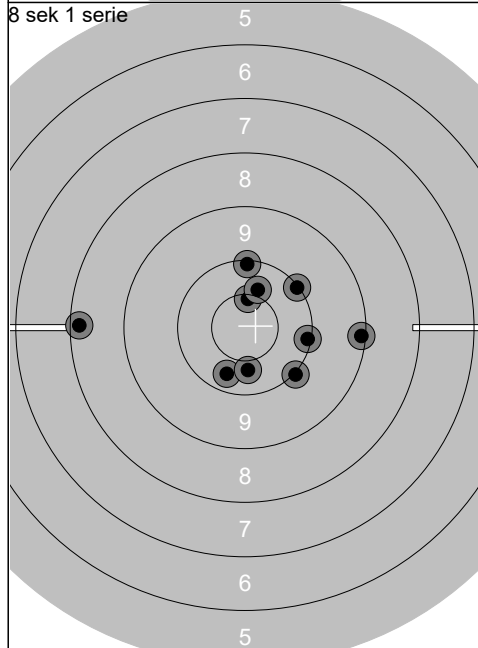

2.63s	10.1	→
3.56s	10.3	↘
4.57s	10.0	↘
5.71s	10.1	↑
6.43s	9.1	→
2.77s	10.4	↘
3.77s	10.6x	↑
4.79s	10.4	↑
5.79s	10.1	↗
6.98s	8.2	←
<b>Serie</b>	<b>97 ( 1x)</b>	
<b>Total</b>	<b>281 ( 4x)</b>	

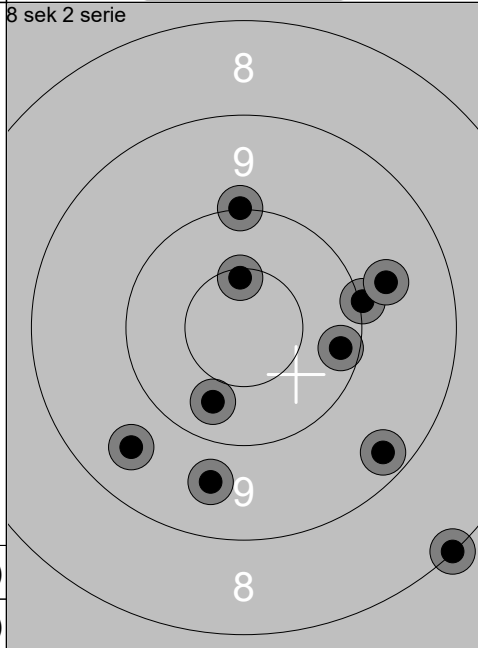

2.96s	10.0	↑
4.04s	10.3	↘
5.05s	9.3	↘
6.04s	10.0	→
6.77s	9.6	↙
2.60s	10.2	→
4.16s	9.6	↘
5.01s	10.6x	↑
5.80s	8.1	↘
6.75s	9.7	→
<b>Serie</b>	<b>94 ( 1x)</b>	
<b>Total</b>	<b>375 ( 5x)</b>	

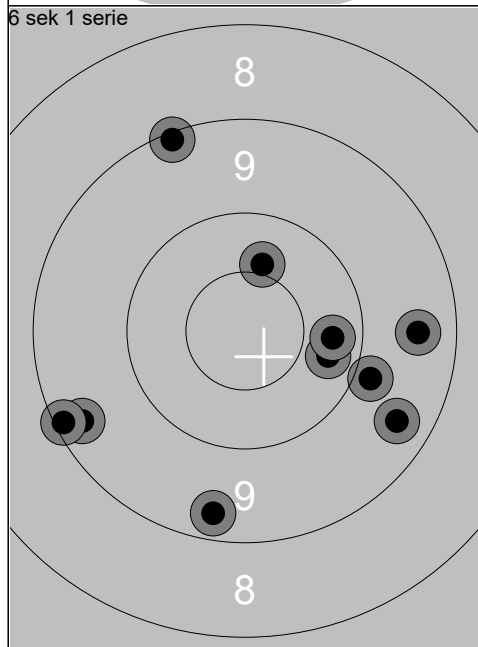

2.35s	9.4	←
3.14s	10.3	→
3.77s	9.2	←
4.34s	9.4	↘
4.95s	10.3	→
2.52s	10.4x	↑
3.13s	9.2	↑
3.73s	9.4	↘
4.30s	9.9	→
4.88s	9.5	→
<b>Serie</b>	<b>93 ( 1x)</b>	
<b>Total</b>	<b>468 ( 6x)</b>	

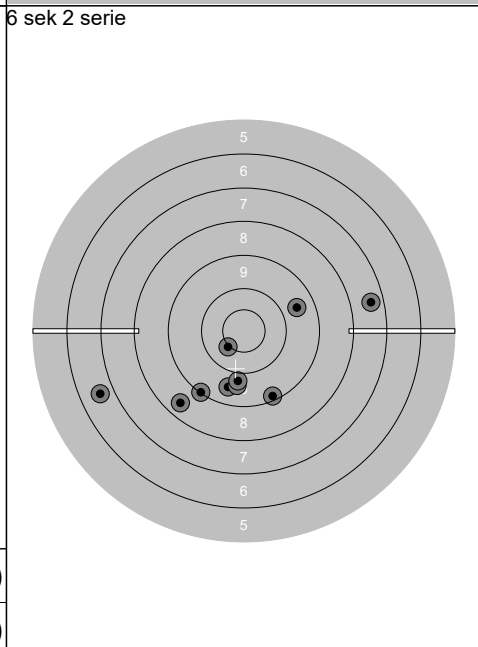

2.71s	6.7	←
3.50s	9.6	↘
4.17s	9.2	↘
4.71s	9.7	↘
5.28s	8.5	↙
2.37s	9.8	↘
3.01s	7.4	→
3.63s	9.6	↗
4.19s	10.5x	↙
4.76s	9.1	↘
<b>Serie</b>	<b>85 ( 1x)</b>	
<b>Total</b>	<b>553 ( 7x)</b>	

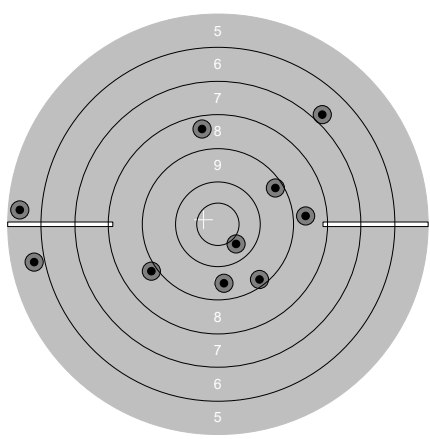
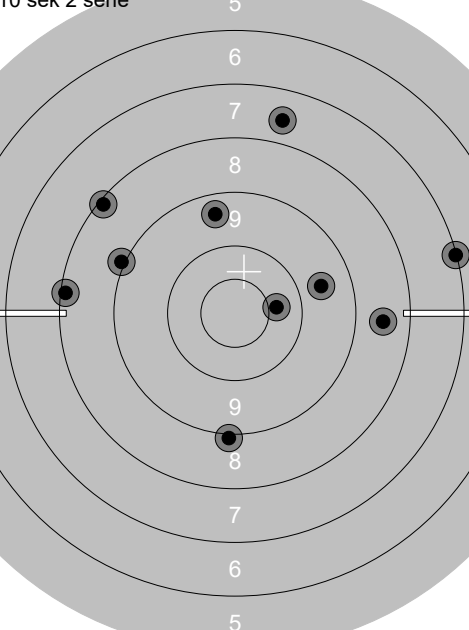
<p>10 sek 1 serie</p> 	<p>3.00s 9.5 ↓</p> <p>4.59s 5.4 ←</p> <p>5.44s 5.7 ←</p> <p>6.43s 8.9 ←</p> <p>7.55s 10.4 ↓</p> <p>2.36s 9.3 ↓</p> <p>3.80s 8.4 ↑</p> <p>4.95s 6.8 ↗</p> <p>6.08s 8.7 →</p> <p>7.07s 9.3 ↗</p> <p><b>Serie 77 ( 0x)</b></p> <p><b>Total 77 ( 0x)</b></p>	<p>10 sek 2 serie</p> 	<p>2.64s 8.2 ←</p> <p>3.79s 9.0 ←</p> <p>5.01s 9.4 ↑</p> <p>6.24s 8.2 ↖</p> <p>7.52s 8.6 →</p> <p>3.33s 9.0 ↓</p> <p>4.63s 7.6 ↑</p> <p>6.00s 10.4 →</p> <p>6.95s 9.6 →</p> <p>8.22s 7.1 →</p> <p><b>Serie 84 ( 0x)</b></p> <p><b>Total 161 ( 0x)</b></p>
---	--	--	---

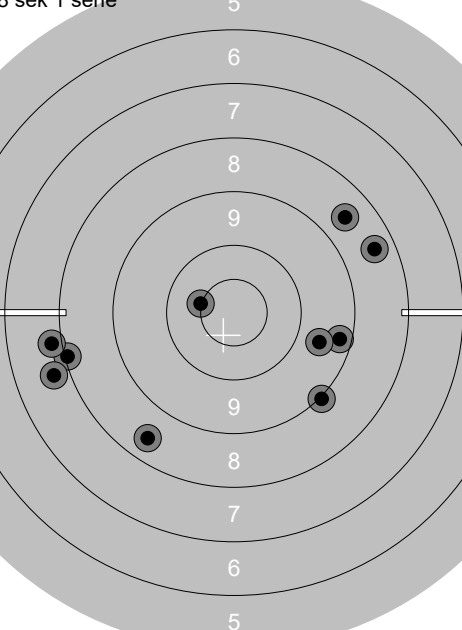
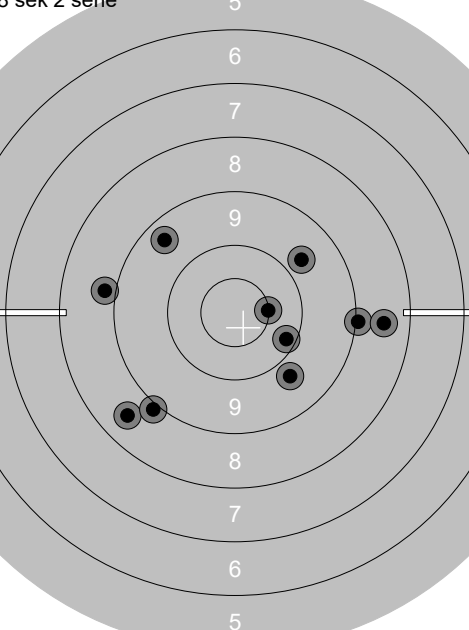
<p>8 sek 1 serie</p> 	<p>3.24s 9.3 →</p> <p>4.75s 9.6 →</p> <p>5.50s 8.1 ←</p> <p>6.38s 8.5 →</p> <p>7.25s 8.6 ↗</p> <p>2.58s 7.9 ←</p> <p>3.61s 10.5x ←</p> <p>4.67s 7.8 ←</p> <p>5.63s 8.5 ↓</p> <p>6.82s 9.0 ↓</p> <p><b>Serie 83 ( 1x)</b></p> <p><b>Total 244 ( 1x)</b></p>	<p>8 sek 2 serie</p> 	<p>2.64s 9.7 ↗</p> <p>3.63s 9.5 ↖</p> <p>4.74s 10.2 ↘</p> <p>6.07s 8.9 ←</p> <p>7.04s 10.5x →</p> <p>2.74s 8.6 ↓</p> <p>4.09s 9.0 ↓</p> <p>5.05s 9.0 →</p> <p>5.92s 8.5 →</p> <p>6.70s 9.8 ↓</p> <p><b>Serie 89 ( 1x)</b></p> <p><b>Total 333 ( 2x)</b></p>
--	--	--	---

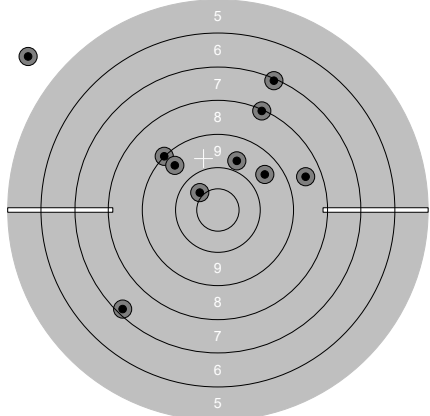
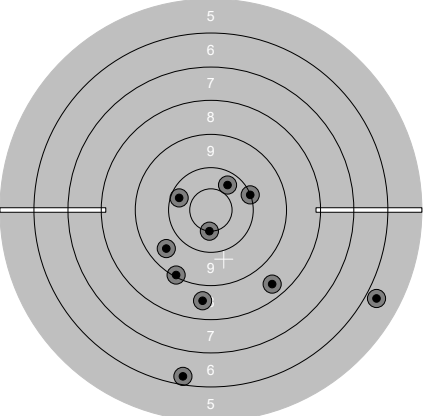
<p>6 sek 1 serie</p> 	<p>2.54s 8.5 →</p> <p>3.36s 9.8 ↑</p> <p>4.13s 9.1 ↖</p> <p>5.27s 7.2 ↓</p> <p>6.11s 0.0 ←</p> <p>2.00s 9.5 ↖</p> <p>2.91s 8.1 ↑</p> <p>3.71s 7.1 ↑</p> <p>4.38s 10.4 ↖</p> <p>5.23s 9.6 ↗</p> <p><b>Serie 76 ( 0x)</b></p> <p><b>Total 409 ( 2x)</b></p>	<p>6 sek 2 serie</p> 	<p>2.33s 10.3 ↗</p> <p>3.45s 10.2 ←</p> <p>4.41s 10.5x ↓</p> <p>5.07s 6.3 ↓</p> <p>5.87s 5.8 →</p> <p>2.00s 10.0 →</p> <p>3.24s 9.6 ↖</p> <p>4.05s 9.1 ↓</p> <p>4.88s 8.6 ↓</p> <p>5.67s 8.5 ↓</p> <p><b>Serie 85 ( 1x)</b></p> <p><b>Total 494 ( 3x)</b></p>
--	---	---	---