

1:	7.2	↑
2:	8.9	→
3:	8.0	←
4:	8.8	←
5:	9.1	←
6:	8.0	↑
7:	9.6	→
8:	7.1	←
9:	9.2	↗
10:	8.0	↑
Serie	81 (0x)	
Total	81 (0x)	

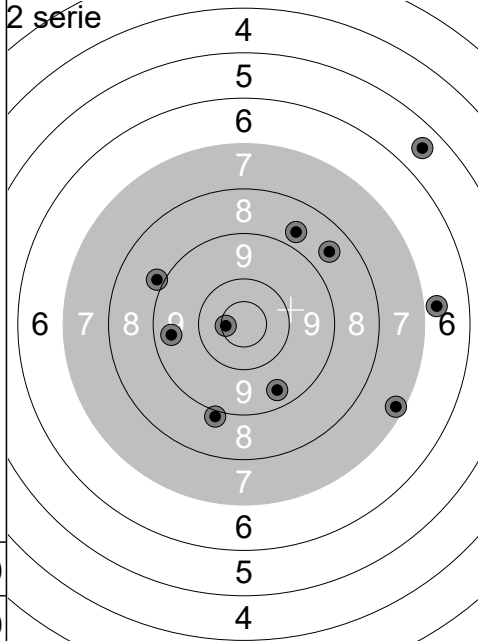

1:	8.9	↓
2:	9.4	←
3:	7.2	↘
4:	8.6	↗
5:	5.5	↗
6:	9.4	↓
7:	6.8	→
8:	8.7	↗
9:	10.6x	←
10:	8.9	↖
Serie	78 (1x)	
Total	159 (1x)	

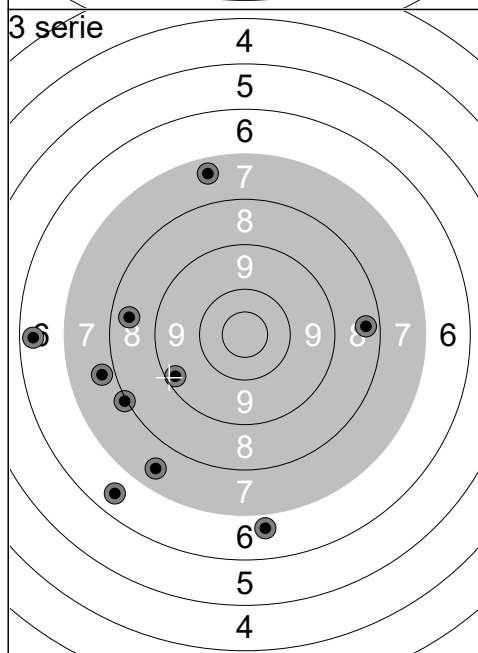

1:	6.7	↓
2:	6.4	←
3:	6.5	↓
4:	7.8	←
5:	8.5	←
6:	8.4	→
7:	7.5	↓
8:	7.4	↑
9:	8.0	←
10:	9.3	↖
Serie	72 (0x)	
Total	231 (1x)	

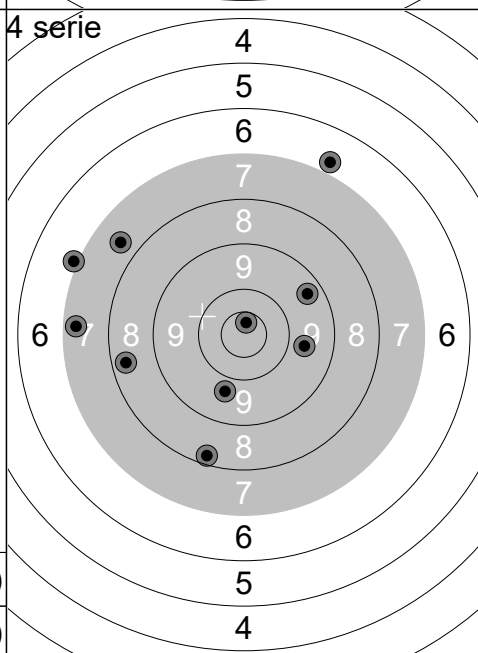

1:	7.7	↖
2:	9.7	→
3:	8.3	↓
4:	6.8	↗
5:	9.4	↗
6:	7.0	←
7:	9.7	↓
8:	7.3	←
9:	10.7x	↑
10:	8.4	←
Serie	80 (1x)	
Total	311 (2x)	

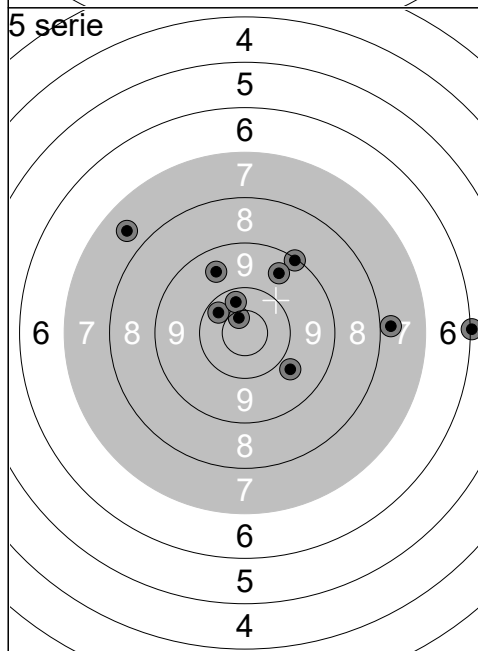

1:	7.8	→
2:	9.1	↗
3:	9.8	↘
4:	10.6x	↑
5:	7.6	↖
6:	10.3	↖
7:	9.6	↑
8:	10.3	↑
9:	9.5	↗
10:	6.0	→
Serie	86 (1x)	
Total	397 (3x)	

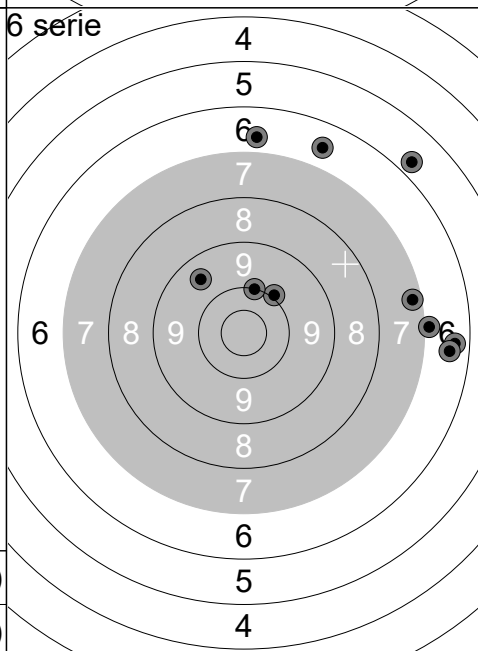

1:	6.6	↗
2:	10.0	↗
3:	6.4	→
4:	5.8	↗
5:	7.3	→
6:	9.5	↖
7:	7.0	→
8:	10.1	↑
9:	6.7	↑
10:	6.5	→
Serie	72 (0x)	
Total	469 (3x)	

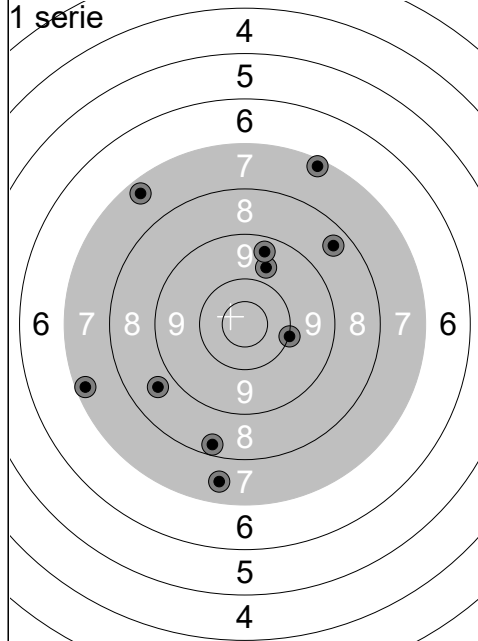

1:	7.4	↖
2:	9.7	↗
3:	8.3	↘
4:	7.2	↗
5:	7.5	↘
6:	8.7	↖
7:	10.0	→
8:	9.4	↗
9:	8.4	↗
10:	7.3	↖
Serie		80 (0x)
Total		80 (0x)

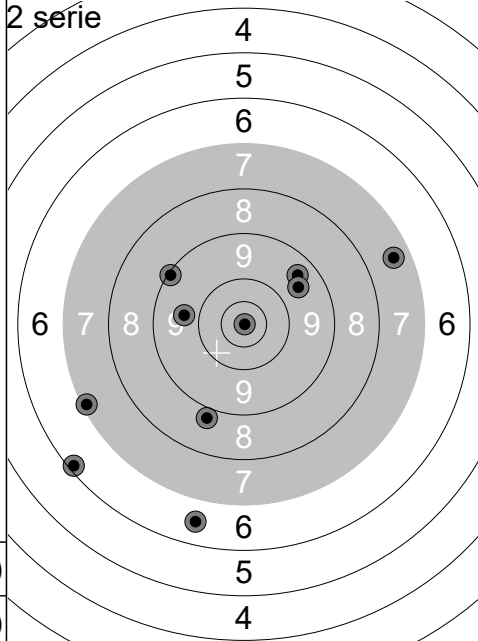

1:	6.6	↘
2:	9.1	↖
3:	7.4	↗
4:	7.1	↖
5:	9.4	↗
6:	9.6	↗
7:	8.8	↘
8:	6.2	↖
9:	10.9x	→
10:	9.7	↖
Serie		80 (1x)
Total		160 (1x)

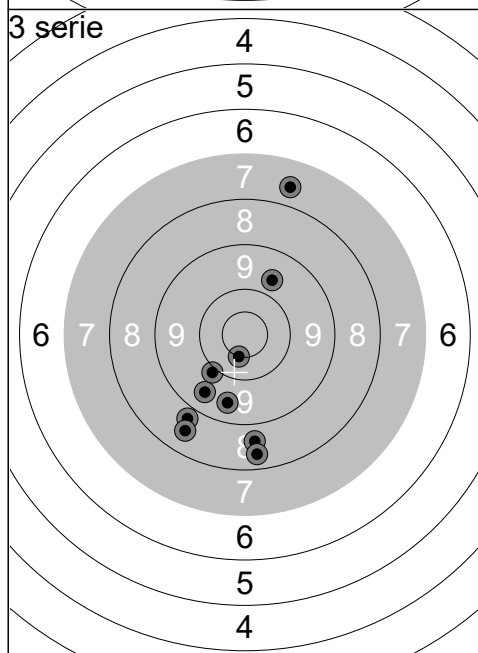

1:	8.7	↘
2:	9.5	↘
3:	8.8	↘
4:	8.5	↘
5:	9.7	↗
6:	9.5	↘
7:	8.4	↘
8:	10.0	↘
9:	7.6	↗
10:	10.5x	↘
Serie		86 (1x)
Total		246 (2x)

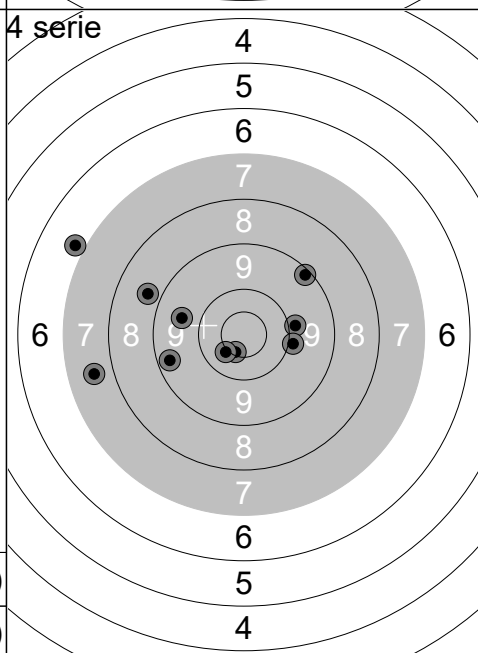

1:	8.7	↖
2:	9.9	→
3:	10.6x	↘
4:	9.2	↗
5:	10.4x	↖
6:	9.6	↖
7:	6.8	↖
8:	9.9	→
9:	9.3	↖
10:	7.6	↖
Serie		86 (2x)
Total		332 (4x)

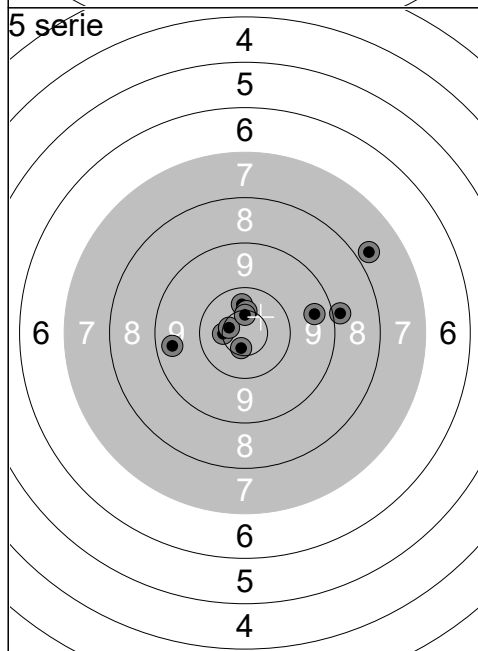

1:	9.4	↖
2:	10.4	↗
3:	10.5x	↖
4:	10.6x	↖
5:	8.9	→
6:	9.5	→
7:	10.5x	↗
8:	7.8	↗
9:	10.6x	↘
10:	10.6x	↗
Serie		93 (5x)
Total		425 (9x)

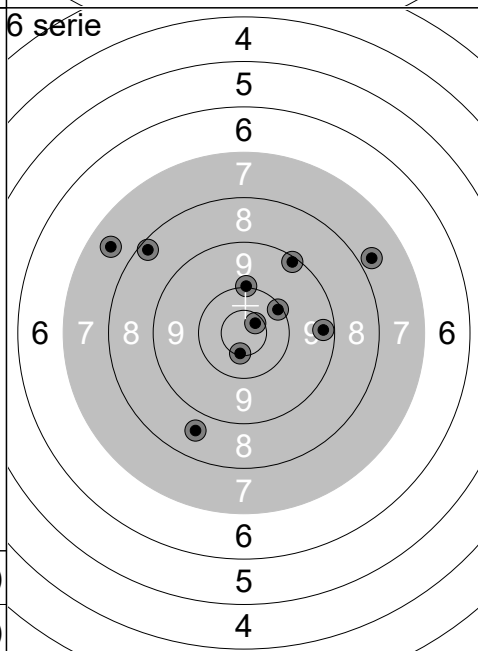

1:	9.2	↗
2:	10.7x	↗
3:	10.1	↗
4:	9.3	→
5:	7.8	↗
6:	7.5	↖
7:	10.5x	↘
8:	8.2	↖
9:	10.0	↗
10:	8.6	↘
Serie		88 (2x)
Total		513 (11x)

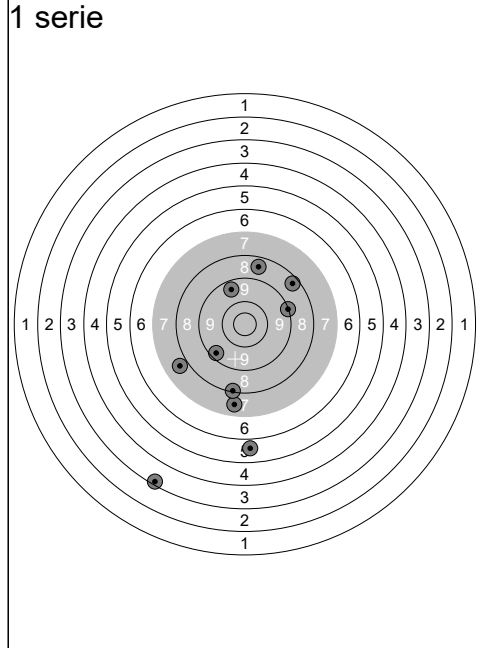

1:	5.7	↓
2:	8.3	↗
3:	9.3	↖
4:	9.4	↖
5:	7.6	↓
6:	8.5	↗
7:	8.1	↓
8:	3.2	↓
9:	7.7	↖
10:	9.1	↗
Serie		73 (0x)
Total		73 (0x)

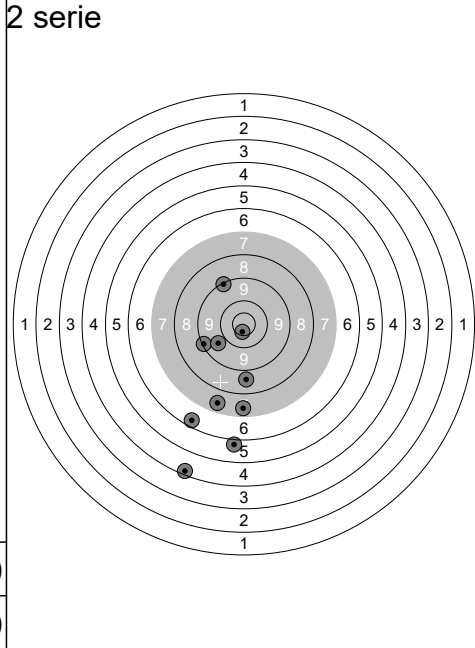

1:	9.1	↖
2:	5.8	↓
3:	7.5	↓
4:	4.2	↓
5:	9.1	↖
6:	6.3	↖
7:	10.6x	↓
8:	7.4	↓
9:	8.7	↓
10:	9.7	↖
Serie		74 (1x)
Total		147 (1x)

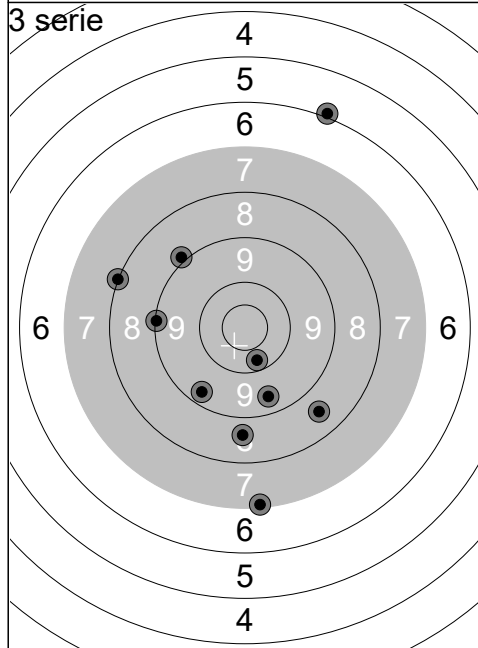

1:	7.1	↓
2:	9.3	↖
3:	9.0	↖
4:	8.1	↖
5:	6.0	↗
6:	10.3	↓
7:	9.1	↖
8:	9.5	↓
9:	8.7	↓
10:	8.6	↘
Serie		83 (0x)
Total		230 (1x)

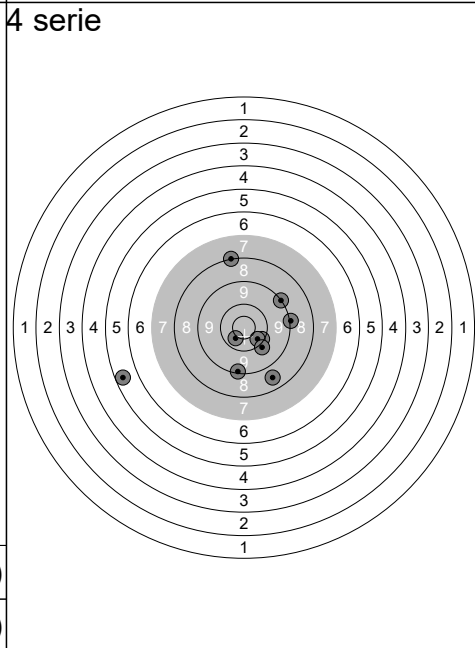

1:	10.1	↗
2:	8.6	↘
3:	9.2	↓
4:	9.0	↗
5:	10.3	↘
6:	9.1	↗
7:	9.9	↘
8:	8.0	↗
9:	10.4x	↘
10:	5.4	↖
Serie		87 (1x)
Total		317 (2x)

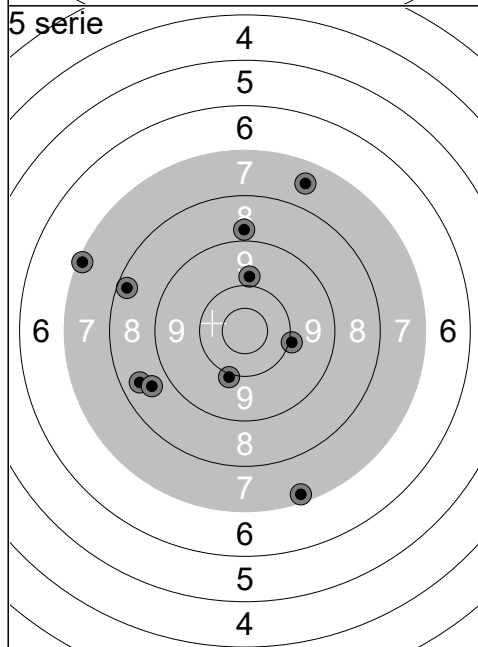

1:	7.2	↓
2:	8.5	↖
3:	10.0	↓
4:	7.1	↖
5:	10.0	↗
6:	8.7	↖
7:	7.5	↗
8:	9.8	↗
9:	8.8	↗
10:	8.3	↖
Serie		82 (0x)
Total		399 (2x)

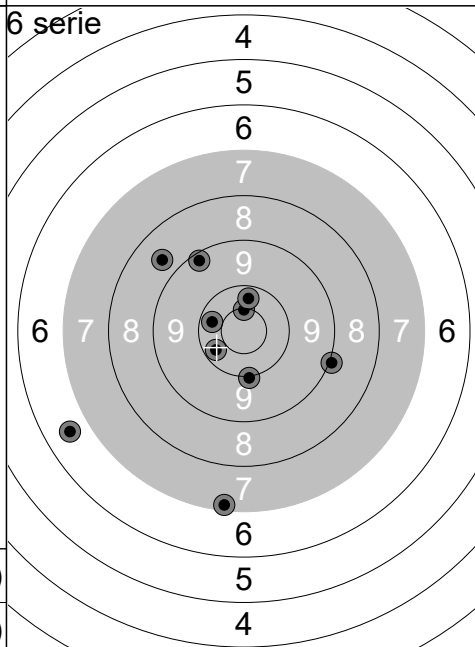

1:	10.5x	↑
2:	9.2	↖
3:	10.0	↓
4:	9.0	↗
5:	10.3	↖
6:	10.3	↖
7:	10.3	↗
8:	7.2	↓
9:	6.6	↖
10:	8.7	↖
Serie		89 (1x)
Total		488 (3x)

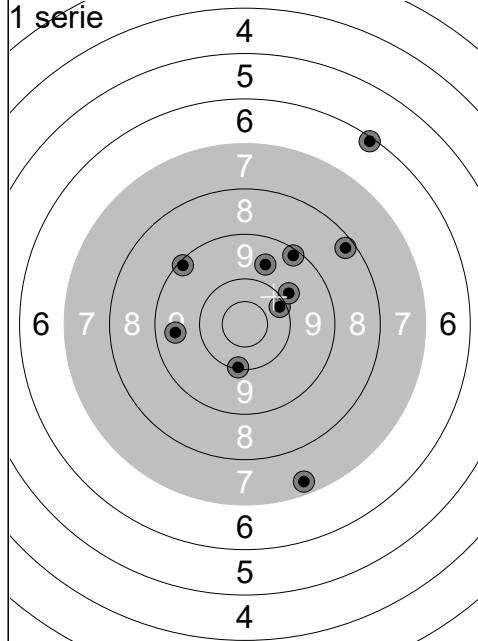

1:	8.3	↗
2:	9.7	↗
3:	10.1	↓
4:	9.2	↗
5:	7.3	↓
6:	10.2	↗
7:	9.9	↗
8:	9.5	←
9:	9.2	↖
10:	6.2	↗
Serie	86 (0x)	
Total	86 (0x)	

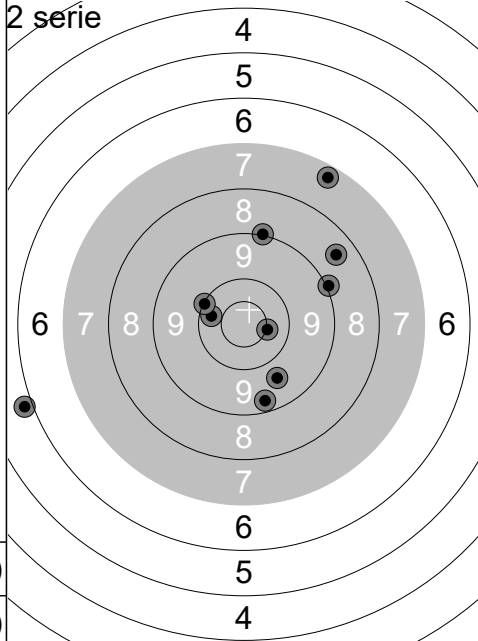

1:	9.7	↘
2:	9.0	↗
3:	5.9	←
4:	7.3	↗
5:	9.0	↗
6:	10.3	←
7:	8.5	↗
8:	10.5x	→
9:	9.3	↓
10:	10.1	↖
Serie	86 (1x)	
Total	172 (1x)	

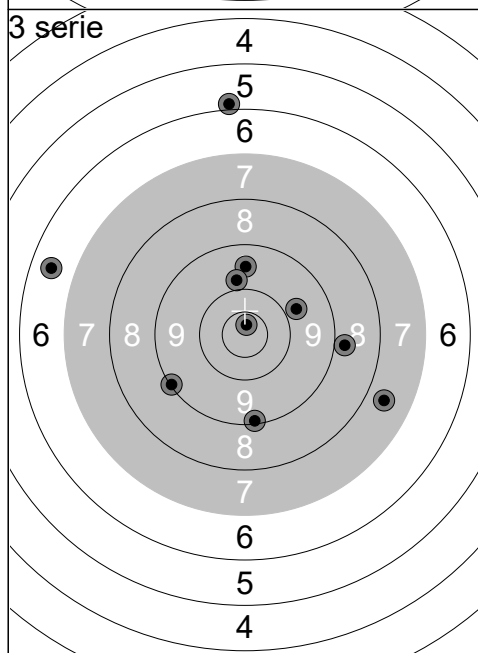

1:	10.7x	↑
2:	5.9	↑
3:	9.8	↗
4:	9.1	↓
5:	9.6	↑
6:	8.8	→
7:	9.8	↑
8:	9.1	↖
9:	7.7	→
10:	6.5	←
Serie	81 (1x)	
Total	253 (2x)	

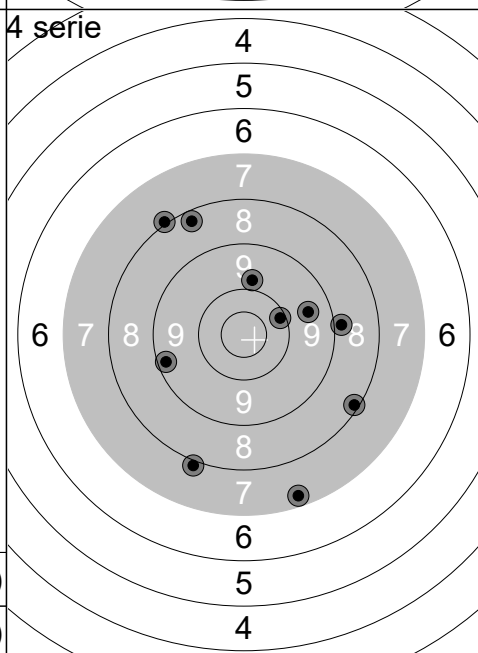

1:	8.9	→
2:	9.2	←
3:	8.0	↓
4:	7.3	↓
5:	9.5	↗
6:	8.2	↘
7:	10.2	↗
8:	8.0	↗
9:	8.3	↗
10:	9.8	↑
Serie	84 (0x)	
Total	337 (2x)	

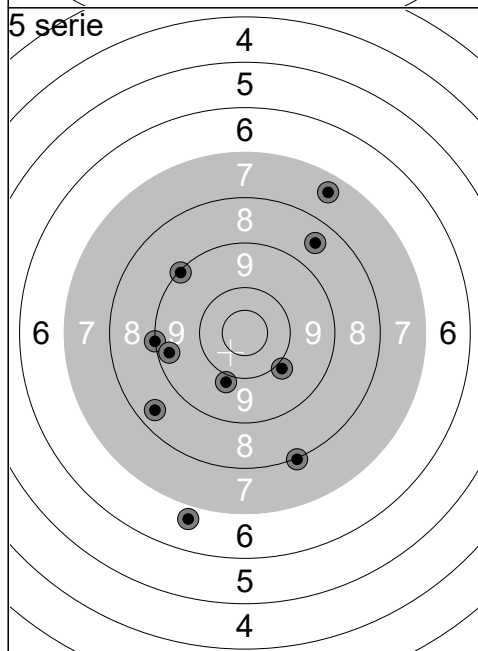

1:	8.5	↗
2:	6.7	↓
3:	9.1	←
4:	7.4	↗
5:	8.4	↖
6:	9.1	↗
7:	9.9	↓
8:	9.3	←
9:	8.0	↓
10:	9.9	↘
Serie	82 (0x)	
Total	419 (2x)	

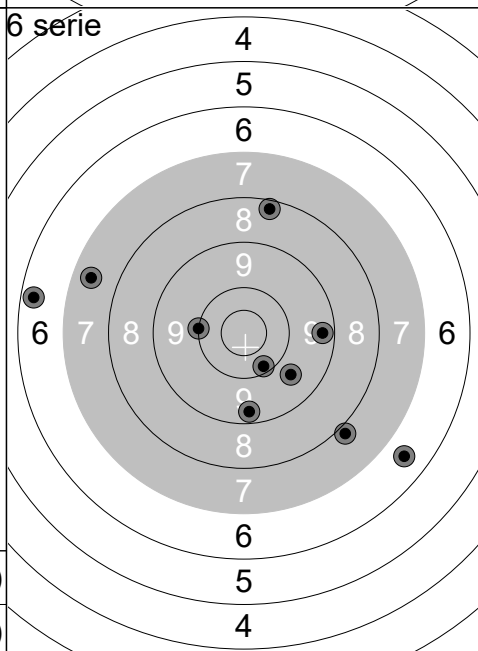

1:	9.7	↘
2:	10.2	↘
3:	7.5	←
4:	6.6	↘
5:	9.3	↓
6:	7.9	↘
7:	9.3	→
8:	10.0	←
9:	6.3	←
10:	8.3	↑
Serie	81 (0x)	
Total	500 (2x)	

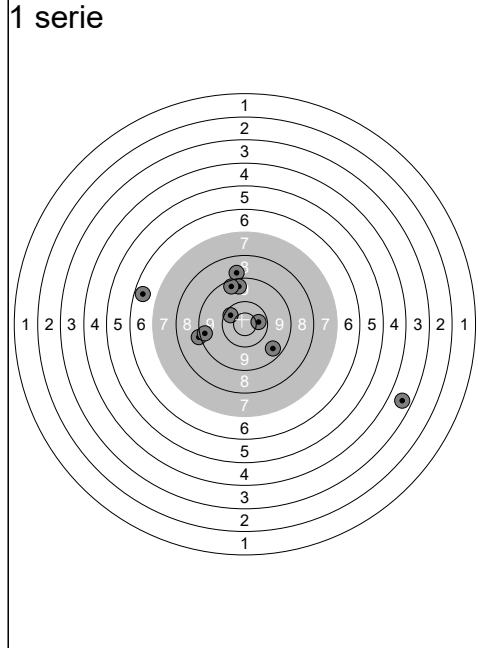

1:	3.5	↘
2:	9.0	←
3:	8.8	↑
4:	10.3	↖
5:	9.5	↘
6:	9.3	←
7:	9.4	↑
8:	6.5	←
9:	9.3	↑
10:	10.4x	→
Serie	82	(1x)
Total	82	(1x)

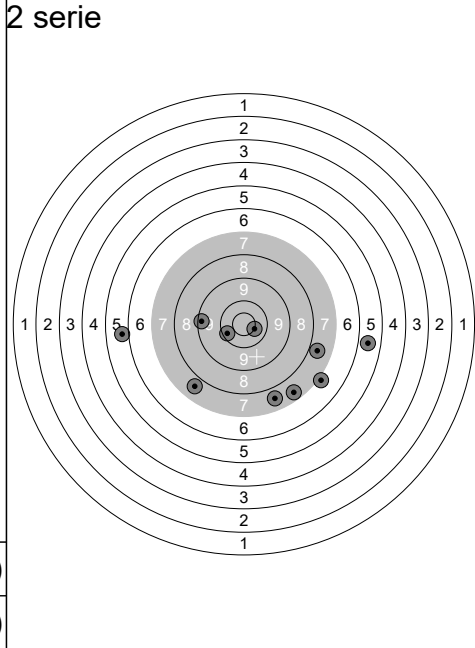

1:	10.2	↙
2:	7.6	↘
3:	9.2	←
4:	5.6	→
5:	7.7	↘
6:	10.5x	→
7:	7.4	↘
8:	7.7	→
9:	6.9	↘
10:	5.8	←
Serie	73	(1x)
Total	155	(2x)

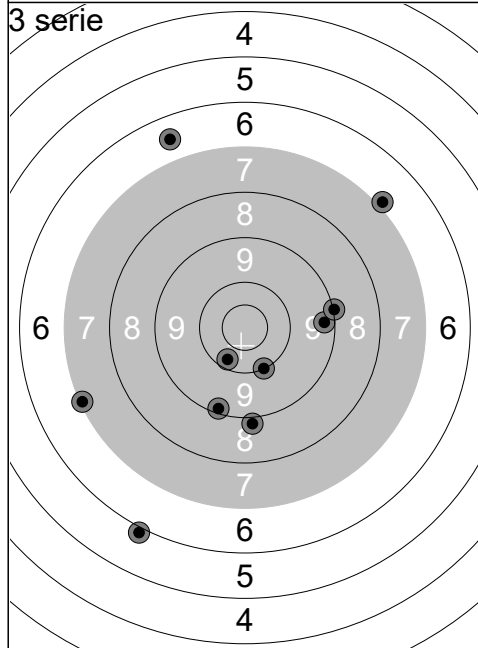

1:	6.0	↘
2:	7.1	←
3:	9.3	→
4:	10.1	↘
5:	9.0	→
6:	9.2	↘
7:	10.2	↘
8:	6.6	↑
9:	8.9	↘
10:	6.9	↗
Serie	80	(0x)
Total	235	(2x)

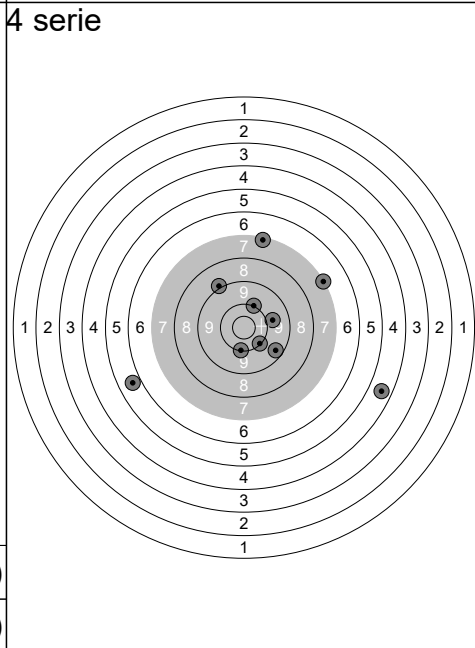

1:	10.1	↘
2:	10.0	↑
3:	9.8	→
4:	7.2	↑
5:	7.1	↗
6:	4.5	→
7:	5.7	←
8:	9.4	↘
9:	10.1	↘
10:	9.0	↗
Serie	80	(0x)
Total	315	(2x)

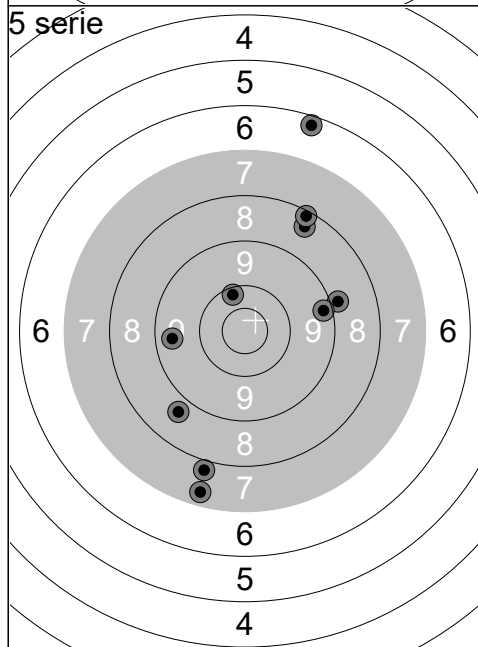

1:	6.3	↑
2:	8.4	↗
3:	8.9	→
4:	7.9	↘
5:	9.4	←
6:	7.4	↘
7:	8.2	↑
8:	10.2	↑
9:	8.7	↘
10:	9.3	→
Serie	80	(0x)
Total	395	(2x)

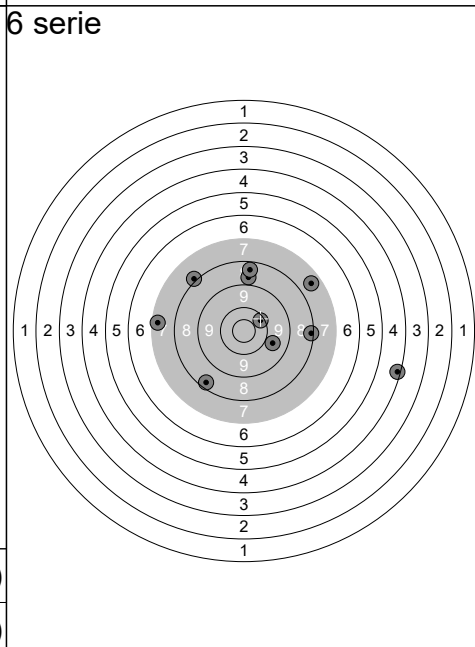

1:	10.2	↗
2:	7.3	←
3:	8.7	↑
4:	8.4	↑
5:	9.7	→
6:	8.3	↘
7:	4.2	→
8:	7.5	↗
9:	8.2	→
10:	7.9	↖
Serie	76	(0x)
Total	471	(2x)

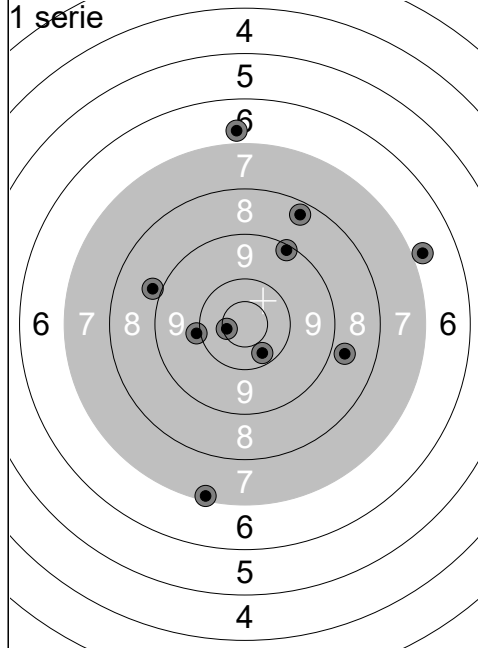

1:	8.3	↗
2:	8.9	↖
3:	7.2	↓
4:	9.2	↗
5:	10.6x	↖
6:	6.8	→
7:	6.8	↑
8:	10.3	↓
9:	8.8	→
10:	10.0	↖
Serie	82 (1x)	
Total	82 (1x)	

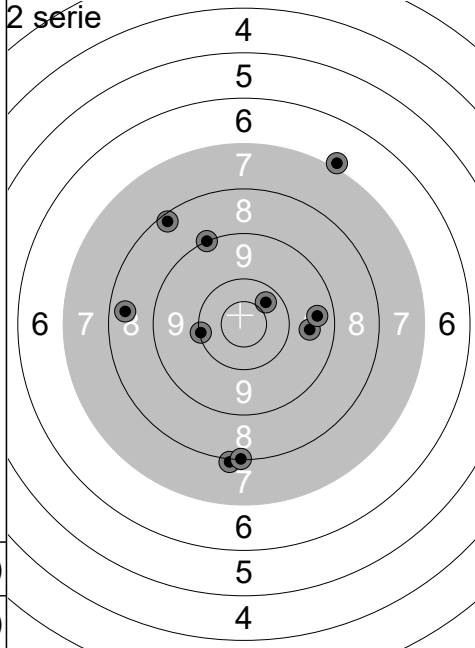

1:	8.0	↓
2:	8.4	↖
3:	10.1	↖
4:	9.6	→
5:	8.1	↓
6:	10.3	↗
7:	6.9	↗
8:	9.0	↗
9:	9.4	→
10:	8.2	↖
Serie	85 (0x)	
Total	167 (1x)	

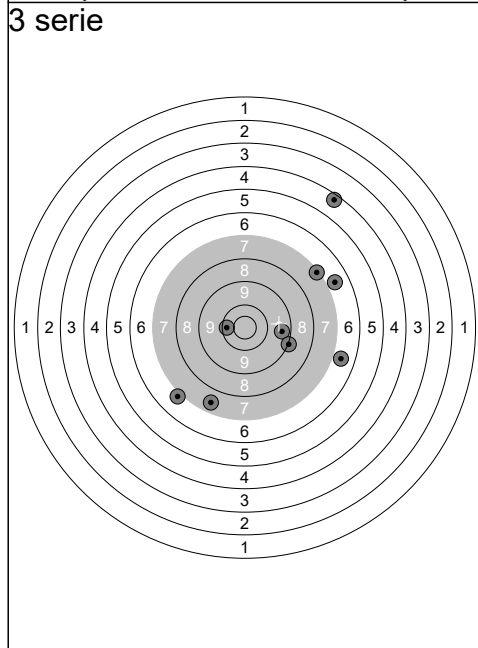

1:	9.4	→
2:	7.5	↓
3:	6.9	↖
4:	9.0	→
5:	4.3	↗
6:	7.1	↗
7:	10.3	↖
8:	6.7	↗
9:	6.7	→
10:	0.0	
Serie	64 (0x)	
Total	231 (1x)	

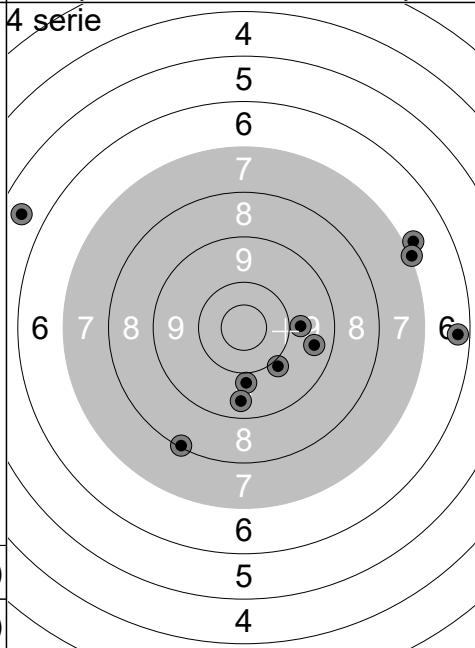

1:	9.5	→
2:	9.8	→
3:	5.5	↖
4:	6.9	↗
5:	6.3	→
6:	9.8	↓
7:	9.4	↓
8:	9.9	↘
9:	7.0	↗
10:	8.1	↓
Serie	77 (0x)	
Total	308 (1x)	

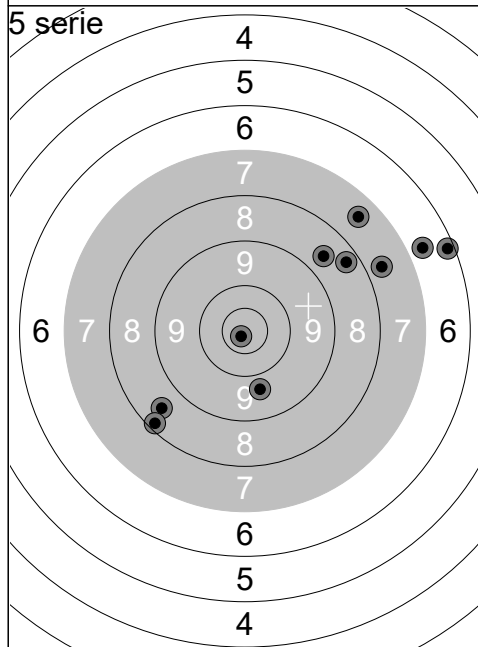

1:	8.6	↖
2:	7.7	↗
3:	8.7	↗
4:	6.7	↗
5:	8.4	↗
6:	6.2	→
7:	7.5	↗
8:	10.8x	↘
9:	8.2	↘
10:	9.7	↓
Serie	77 (1x)	
Total	385 (2x)	

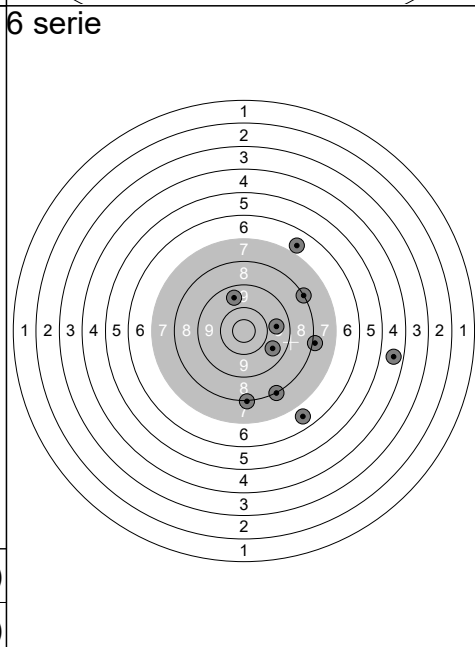

1:	6.6	↘
2:	9.6	↘
3:	8.0	↓
4:	9.6	→
5:	6.7	↗
6:	8.0	↓
7:	8.0	↗
8:	7.9	→
9:	9.6	↑
10:	4.5	→
Serie	74 (0x)	
Total	459 (2x)	

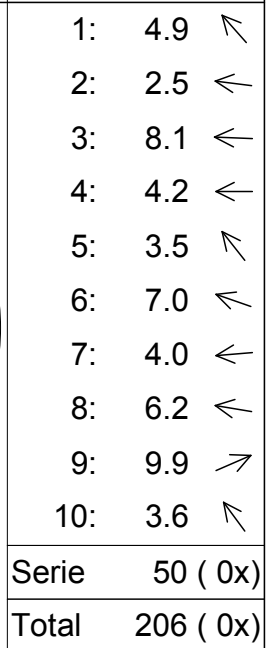
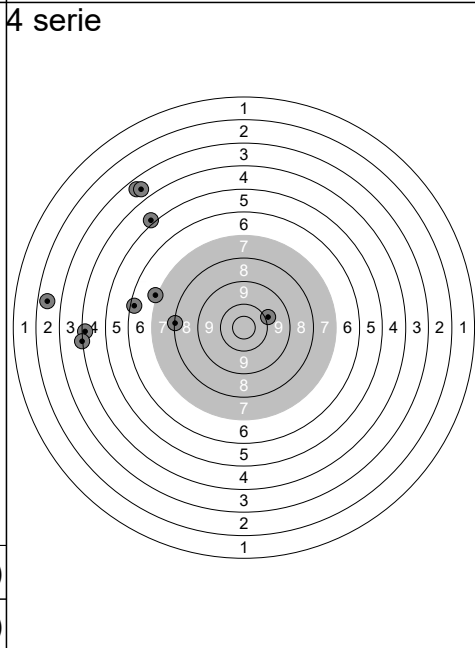
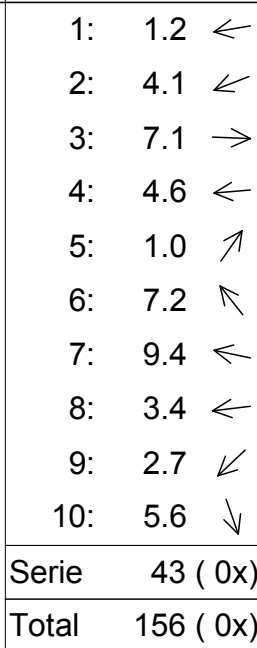
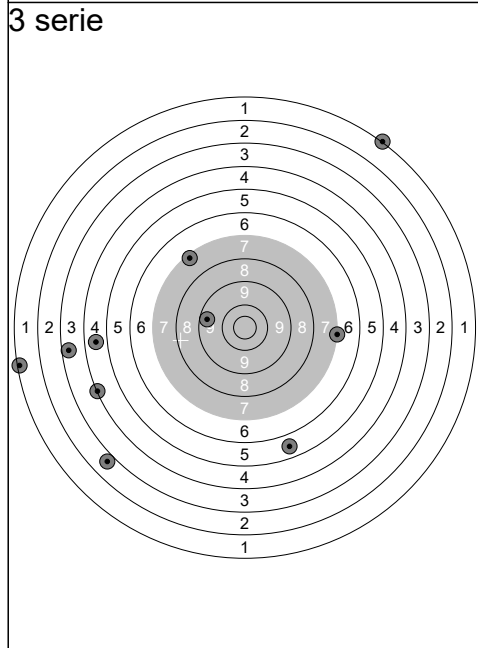
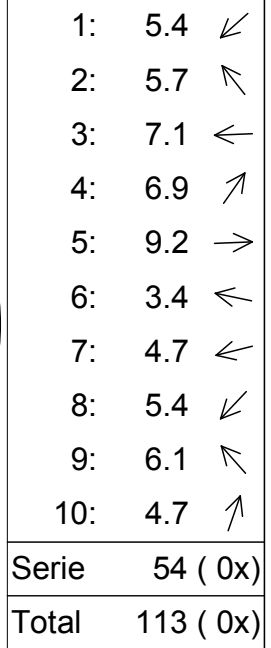
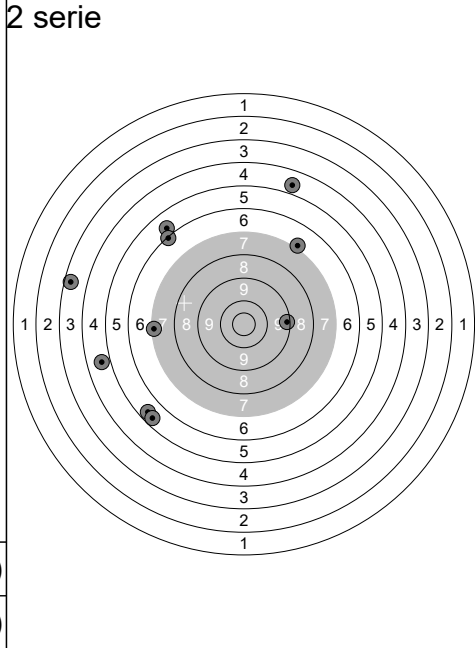
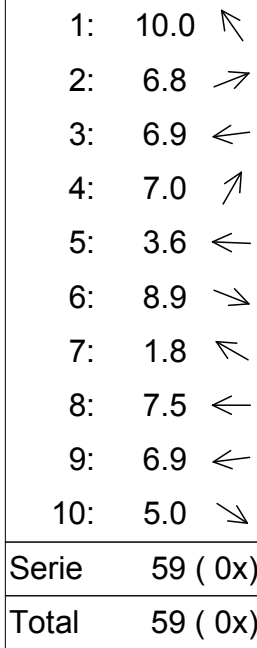
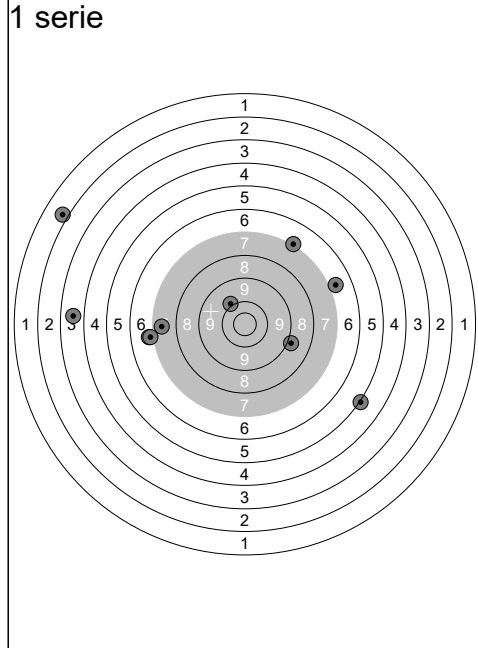

1 serie

1:	8.9	↗
2:	8.9	↖
3:	8.9	↗
4:	7.6	→
5:	8.1	↗
6:	4.9	←
7:	9.3	↗
8:	4.7	↗
9:	7.6	↗
10:	9.7	←
Serie	72 (0x)	
Total	72 (0x)	

2 serie

1:	9.0	↗
2:	3.8	↗
3:	9.5	↖
4:	6.6	↑
5:	10.0	←
6:	6.9	→
7:	9.0	↓
8:	9.9	→
9:	9.4	↘
10:	10.2	→
Serie	80 (0x)	
Total	152 (0x)	

3 serie

1:	9.8	↘
2:	7.0	→
3:	8.2	↘
4:	10.2	↗
5:	10.4x	↖
6:	8.3	↗
7:	9.7	→
8:	7.6	↓
9:	8.6	↘
10:	8.0	←
Serie	84 (1x)	
Total	236 (1x)	

4 serie

1:	9.2	↖
2:	8.4	↗
3:	8.7	↓
4:	7.1	↘
5:	10.7x	↘
6:	7.9	←
7:	8.7	↗
8:	8.1	↓
9:	10.2	↗
10:	4.3	↗
Serie	79 (1x)	
Total	315 (2x)	

5 serie

1:	7.3	↑
2:	9.3	↘
3:	8.5	↗
4:	10.4	↗
5:	9.0	→
6:	6.9	←
7:	7.4	↗
8:	2.8	↘
9:	9.8	↗
10:	9.7	→
Serie	76 (0x)	
Total	391 (2x)	

6 serie

1:	9.2	→
2:	9.1	←
3:	9.1	↓
4:	7.6	←
5:	8.2	→
6:	9.9	↓
7:	9.1	↗
8:	7.3	↗
9:	8.3	↑
10:	8.5	←
Serie	83 (0x)	
Total	474 (2x)	

6 serie

1:	9.2	→
2:	9.1	←
3:	9.1	↓
4:	7.6	←
5:	8.2	→
6:	9.9	↓
7:	9.1	↗
8:	7.3	↗
9:	8.3	↑
10:	8.5	←
Serie	83 (0x)	
Total	474 (2x)	

6 serie

1:	9.2	→
2:	9.1	←
3:	9.1	↓
4:	7.6	←
5:	8.2	→
6:	9.9	↓
7:	9.1	↗
8:	7.3	↗
9:	8.3	↑
10:	8.5	←
Serie	83 (0x)	
Total	474 (2x)	

6 serie

1:	9.2	→
2:	9.1	←
3:	9.1	↓
4:	7.6	←
5:	8.2	→
6:	9.9	↓
7:	9.1	↗
8:	7.3	↗
9:	8.3	↑
10:	8.5	←
Serie	83 (0x)	
Total	474 (2x)	

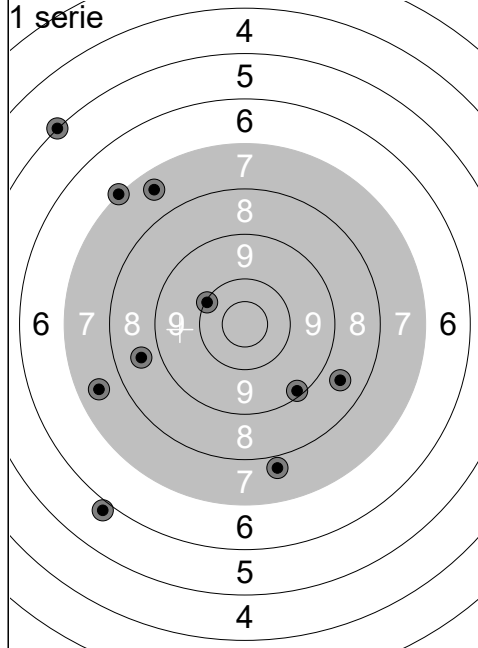

1:	9.2	↘
2:	7.5	←
3:	5.9	↘
4:	8.6	↘
5:	8.6	←
6:	5.1	↗
7:	7.5	↗
8:	7.8	↘
9:	7.0	↗
10:	10.1	←
Serie	73	(0x)
Total	73	(0x)

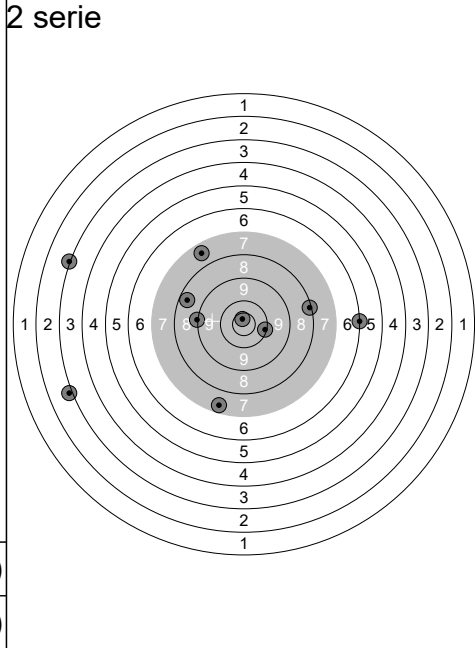

1:	10.7x	↗
2:	7.4	↘
3:	3.0	←
4:	2.9	←
5:	8.1	↗
6:	6.1	↗
7:	9.0	←
8:	10.1	↗
9:	7.5	↗
10:	8.4	←
Serie	70	(1x)
Total	143	(1x)

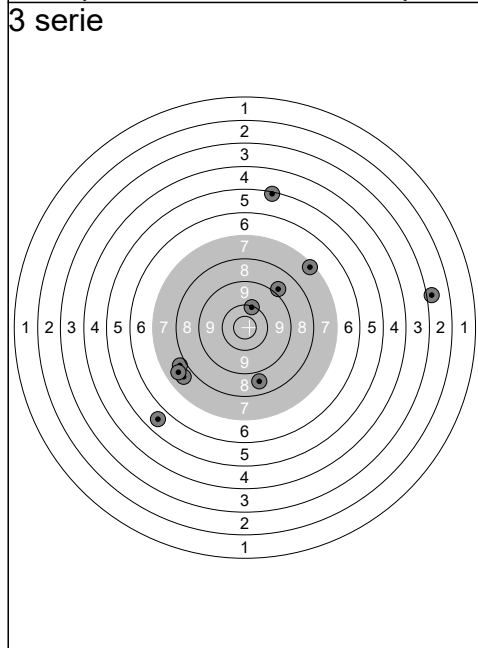

1:	7.6	←
2:	7.8	←
3:	8.7	↘
4:	10.1	↗
5:	8.8	↗
6:	7.6	←
7:	7.2	↗
8:	5.1	↗
9:	5.6	↘
10:	2.8	→
Serie	66	(0x)
Total	209	(1x)

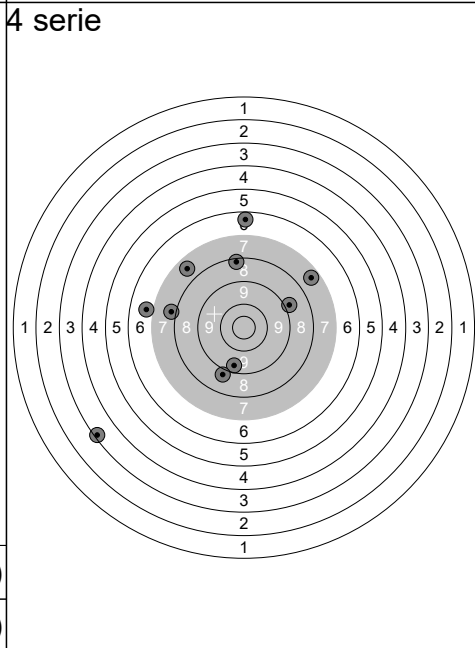

1:	3.2	←
2:	7.8	←
3:	6.8	←
4:	9.4	↘
5:	8.2	↗
6:	8.9	↗
7:	7.5	↗
8:	6.4	↗
9:	8.8	↘
10:	7.4	↗
Serie	69	(0x)
Total	278	(1x)

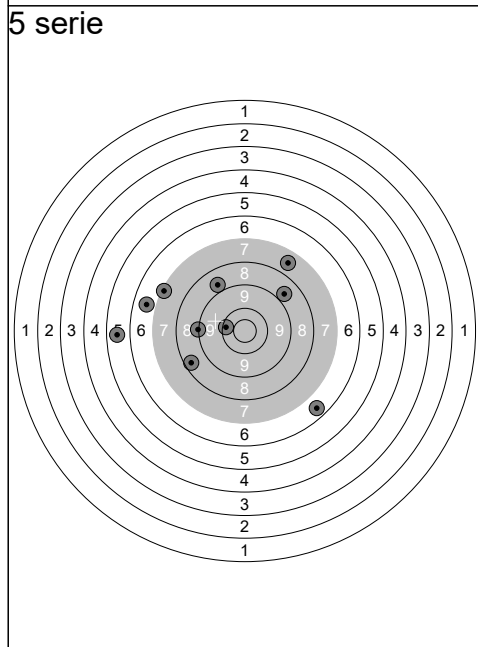

1:	9.0	←
2:	5.5	←
3:	7.1	←
4:	10.2	←
5:	8.7	↗
6:	6.6	←
7:	7.6	↗
8:	6.5	↘
9:	8.7	↗
10:	8.4	←
Serie	74	(0x)
Total	352	(1x)

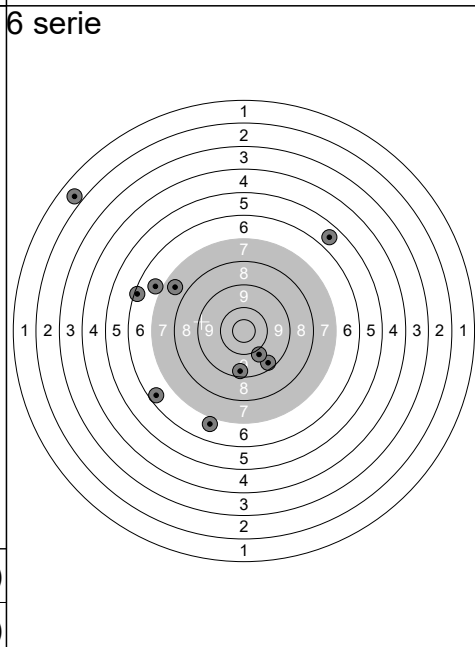

1:	5.6	↗
2:	1.7	↘
3:	9.3	↘
4:	6.3	←
5:	9.3	↘
6:	6.2	←
7:	9.8	↘
8:	6.8	↘
9:	7.5	←
10:	6.8	←
Serie	64	(0x)
Total	416	(1x)

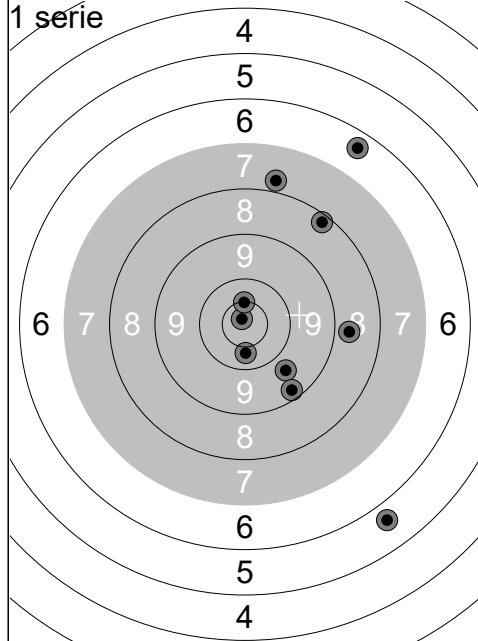

1:	6.4	↗
2:	10.4	↓
3:	10.8x	↖
4:	9.7	↘
5:	7.8	↑
6:	9.3	↘
7:	8.7	→
8:	10.5x	↑
9:	8.2	↗
10:	5.7	↘
Serie		82 (2x)
Total		82 (2x)

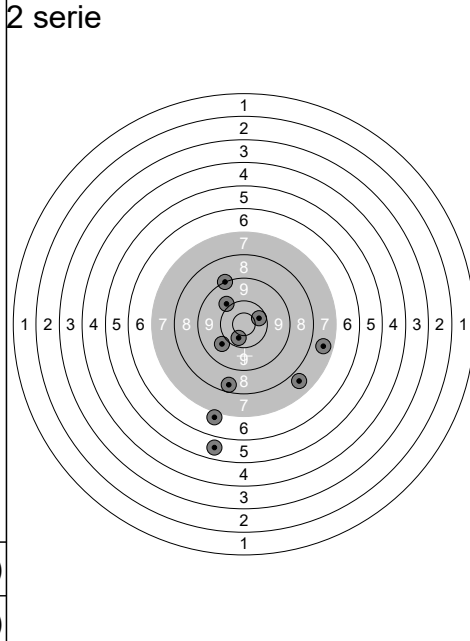

1:	9.8	↙
2:	6.8	↓
3:	7.6	↘
4:	8.3	↘
5:	9.0	↗
6:	10.3	→
7:	7.5	→
8:	10.4	↓
9:	5.6	↓
10:	9.9	↖
Serie		80 (0x)
Total		162 (2x)

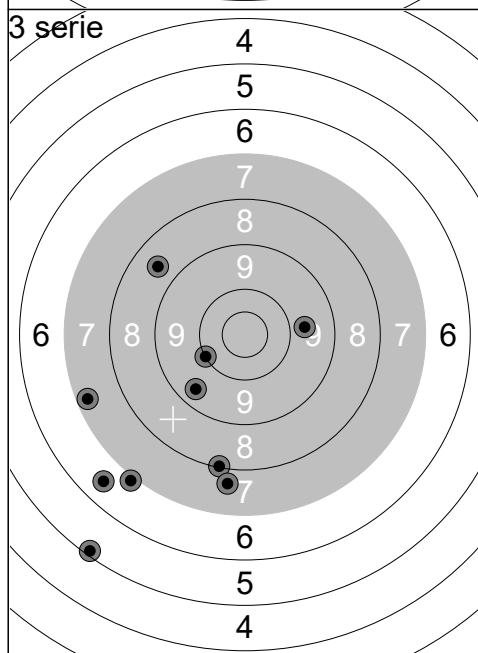

1:	8.1	↓
2:	7.0	↘
3:	10.1	↙
4:	7.7	↓
5:	8.6	↖
6:	9.4	↘
7:	9.7	→
8:	5.2	↓
9:	6.5	↘
10:	7.3	↙
Serie		76 (0x)
Total		238 (2x)

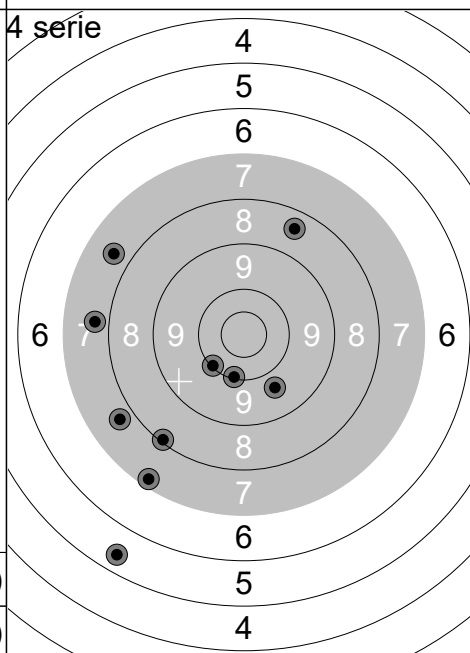

1:	8.1	↙
2:	7.7	↖
3:	7.7	↙
4:	8.5	↗
5:	7.2	↘
6:	5.4	↘
7:	10.1	↓
8:	9.7	↘
9:	10.1	↙
10:	7.7	↙
Serie		78 (0x)
Total		316 (2x)

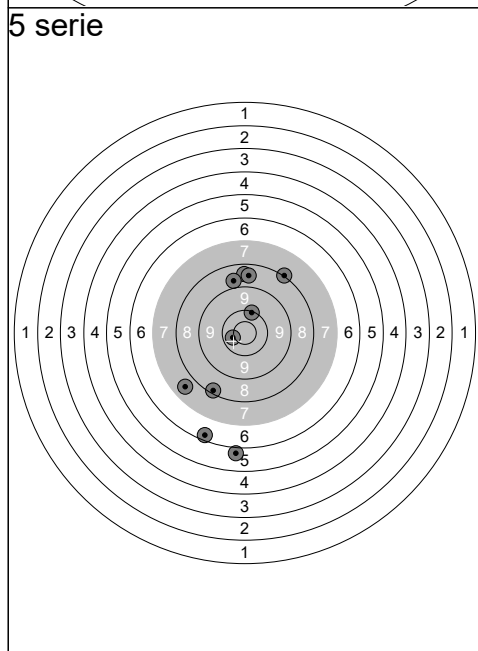

1:	8.2	↘
2:	8.5	↑
3:	10.4x	↙
4:	8.1	↗
5:	8.6	↑
6:	10.1	↗
7:	6.3	↘
8:	7.6	↙
9:	5.8	↘
10:	8.7	↑
Serie		78 (1x)
Total		394 (3x)

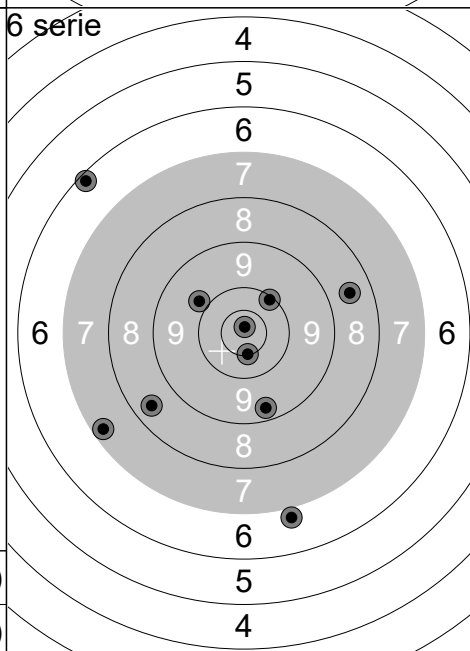

1:	6.8	↓
2:	9.3	↓
3:	6.2	↖
4:	9.8	↖
5:	10.1	↗
6:	8.5	→
7:	7.3	↙
8:	8.5	↙
9:	10.5x	↘
10:	10.8x	↑
Serie		83 (2x)
Total		477 (5x)

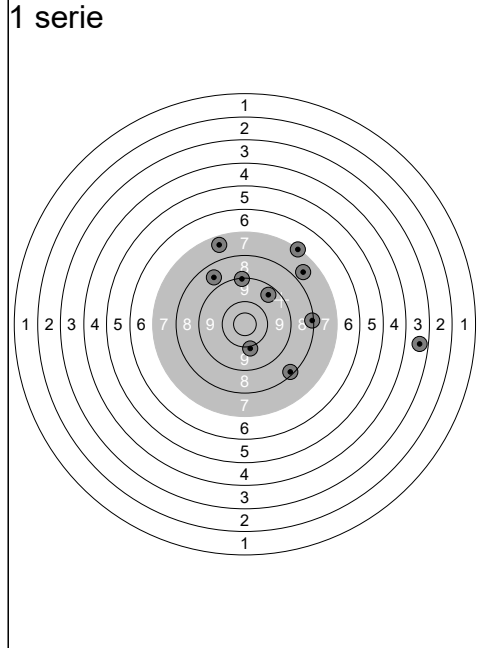

2 serie

1	10.0	↓
2	5.2	↘
3	8.2	↗
4	9.1	↘
5	10.7x	→
6	9.9	↘
7	8.8	↙
8	6.8	←
9	6.3	→
10	9.3	↗
Serie		80 (1x)
Total		156 (1x)

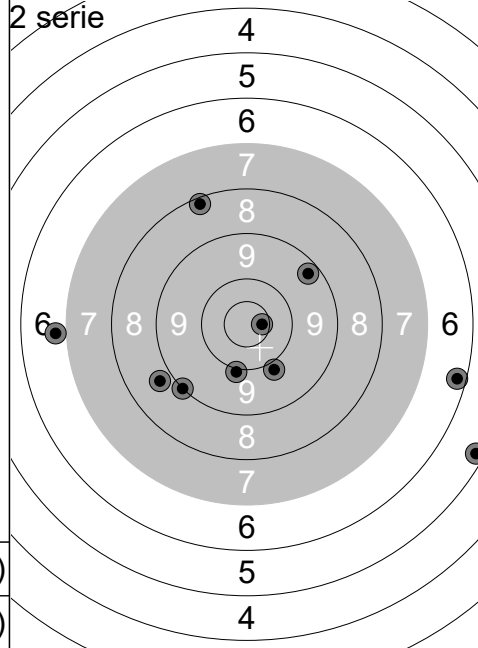

4 serie

1	5.5	↘
2	7.5	↘
3	9.3	↘
4	9.7	↑
5	8.8	↓
6	9.5	↘
7	9.4	↗
8	6.1	↘
9	8.1	←
10	10.6x	↙
Serie		80 (1x)
Total		317 (2x)

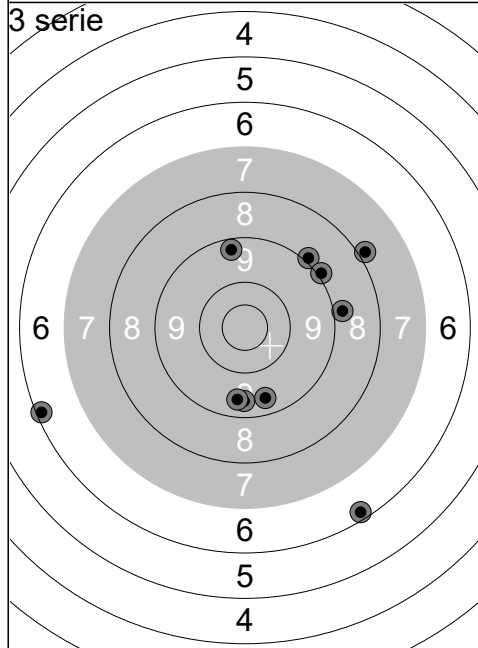

6 serie

1	8.7	↓
2	10.2	↖
3	9.9	→
4	7.5	↘
5	8.1	↘
6	10.0	↑
7	9.6	↗
8	9.6	←
9	7.2	↘
10	8.9	↑
Serie		85 (0x)
Total		476 (2x)

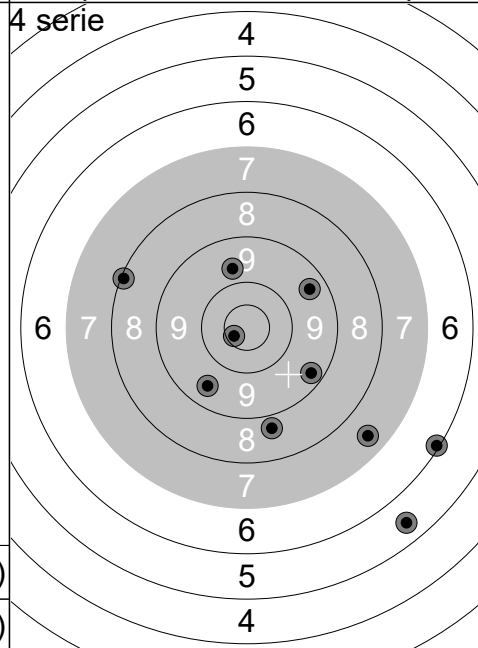

6 serie

1	8.7	↓
2	10.2	↖
3	9.9	→
4	7.5	↘
5	8.1	↘
6	10.0	↑
7	9.6	↗
8	9.6	←
9	7.2	↘
10	8.9	↑
Serie		85 (0x)
Total		476 (2x)

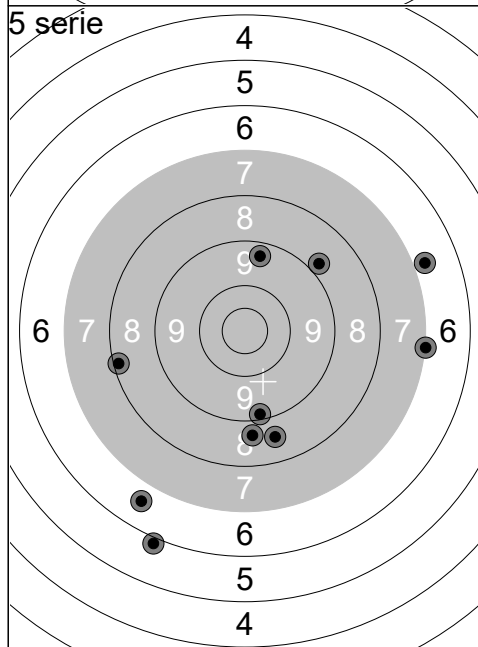

6 serie

1	8.7	↓
2	10.2	↖
3	9.9	→
4	7.5	↘
5	8.1	↘
6	10.0	↑
7	9.6	↗
8	9.6	←
9	7.2	↘
10	8.9	↑
Serie		85 (0x)
Total		476 (2x)

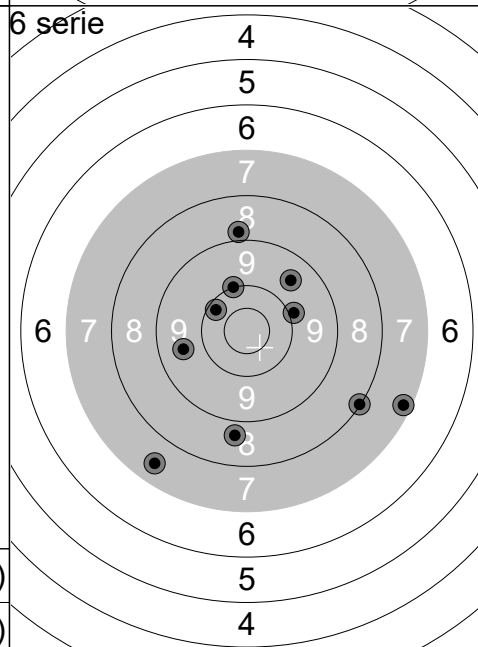

6 serie

1	8.7	↓
2	10.2	↖
3	9.9	→
4	7.5	↘
5	8.1	↘
6	10.0	↑
7	9.6	↗
8	9.6	←
9	7.2	↘
10	8.9	↑
Serie		85 (0x)
Total		476 (2x)

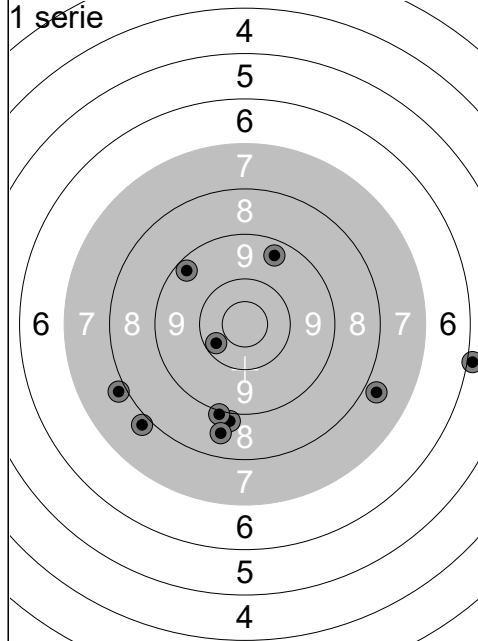

1:	10.3	↙
2:	9.3	↘
3:	8.9	↓
4:	7.8	→
5:	7.9	↙
6:	7.9	↙
7:	9.4	↗
8:	9.0	↓
9:	6.0	→
10:	8.6	↓
Serie	80 (0x)	
Total	80 (0x)	

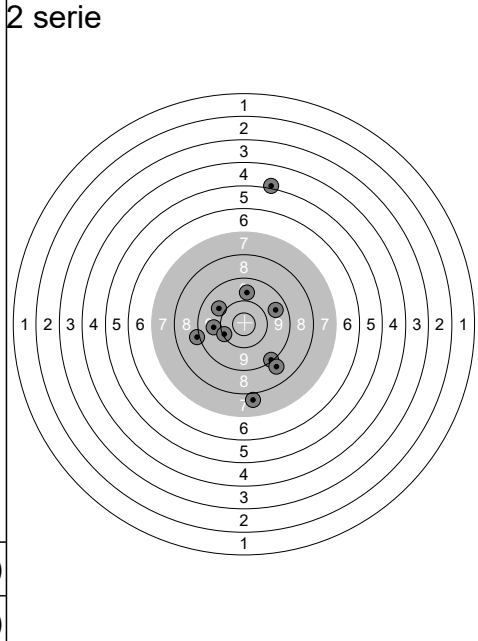

1:	9.8	↙
2:	7.8	↓
3:	9.6	↗
4:	9.8	↙
5:	9.7	↑
6:	9.1	↓
7:	9.0	↙
8:	8.7	↓
9:	5.0	↑
10:	10.1	↙
Serie	84 (0x)	
Total	164 (0x)	

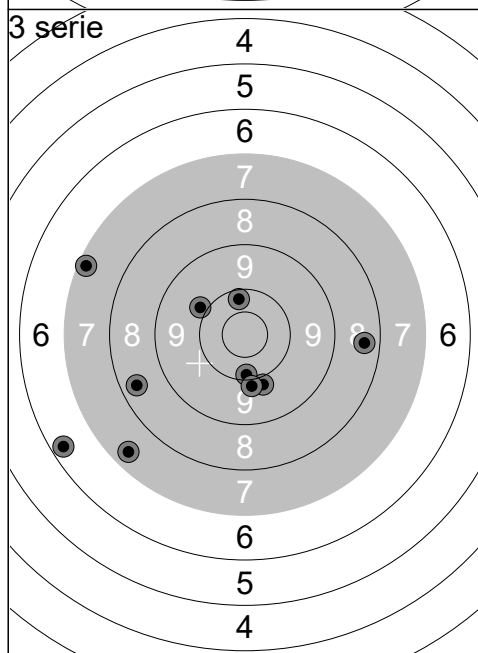

1:	10.1	↓
2:	8.4	→
3:	9.9	↙
4:	7.2	↙
5:	8.4	↙
6:	9.9	↓
7:	10.2	↑
8:	9.9	↓
9:	7.4	↙
10:	6.3	↙
Serie	83 (0x)	
Total	247 (0x)	

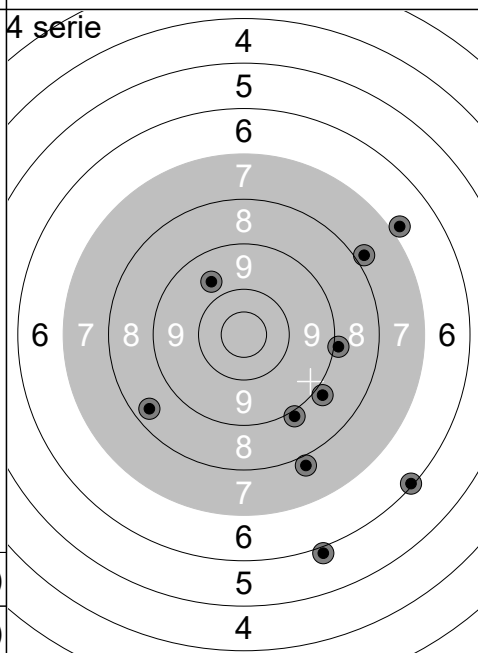

1:	5.9	↓
2:	8.4	↙
3:	6.9	↗
4:	8.9	↓
5:	6.1	↙
6:	7.9	↗
7:	9.0	→
8:	9.7	↗
9:	7.9	↓
10:	8.9	↙
Serie	73 (0x)	
Total	320 (0x)	

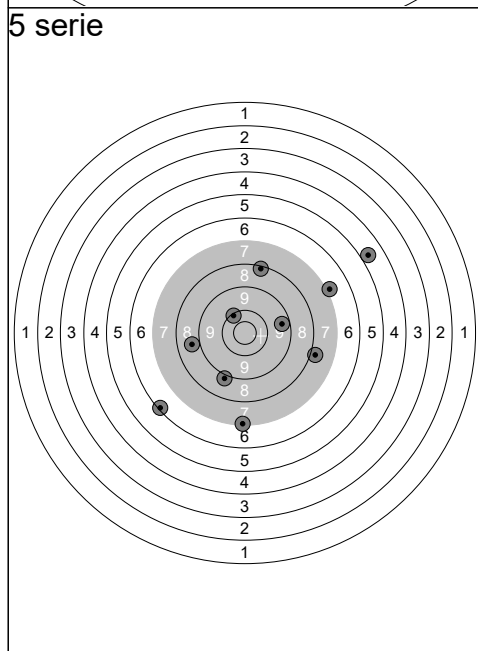

1:	7.9	→
2:	9.4	→
3:	6.1	↙
4:	8.2	↑
5:	8.7	↙
6:	6.9	↗
7:	4.7	↗
8:	10.1	↘
9:	7.1	↓
10:	8.9	↓
Serie	73 (0x)	
Total	393 (0x)	

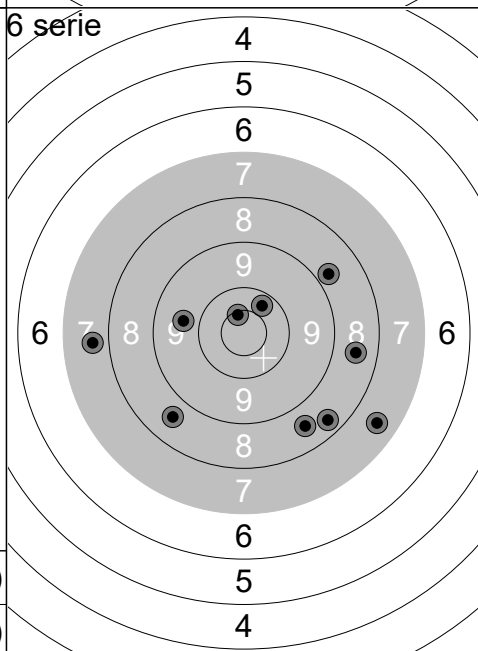

1:	8.8	↗
2:	10.3	↗
3:	7.5	↙
4:	7.7	↙
5:	8.6	↙
6:	8.6	↙
7:	8.5	→
8:	8.4	↙
9:	9.7	↙
10:	10.6x	↗
Serie	83 (1x)	
Total	476 (1x)	

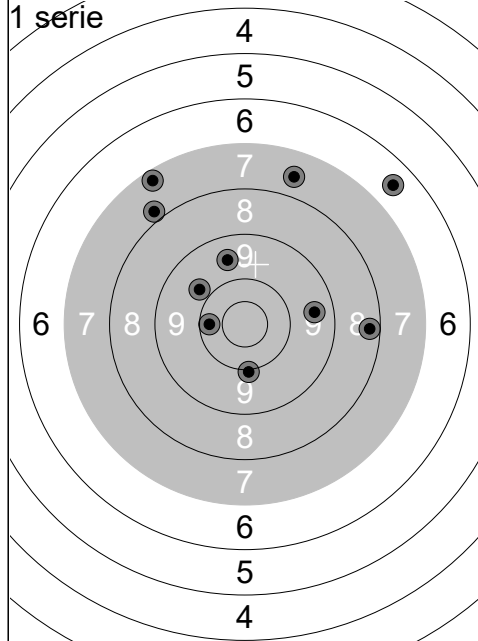

1:	9.6	↗
2:	7.3	↗
3:	6.6	↗
4:	10.0	↓
5:	8.3	→
6:	9.8	↗
7:	10.2	←
8:	7.6	↗
9:	9.5	→
10:	7.9	↗
Serie	82	(0x)
Total	82	(0x)

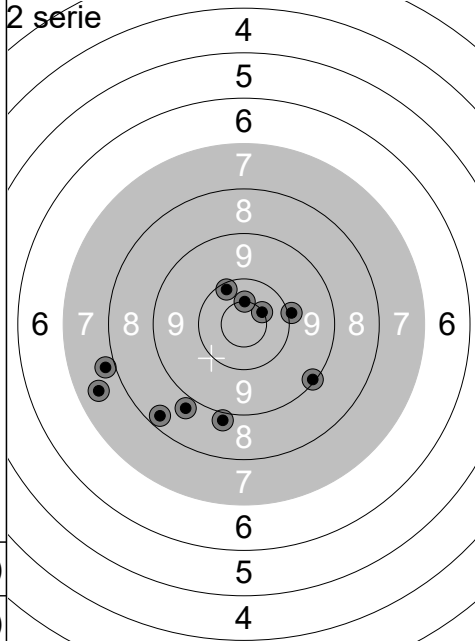

1:	10.0	→
2:	7.8	←
3:	10.5x	↗
4:	7.5	←
5:	10.2	↗
6:	8.3	↘
7:	9.1	↘
8:	8.8	↘
9:	10.5x	↗
10:	8.9	↓
Serie	87	(2x)
Total	169	(2x)

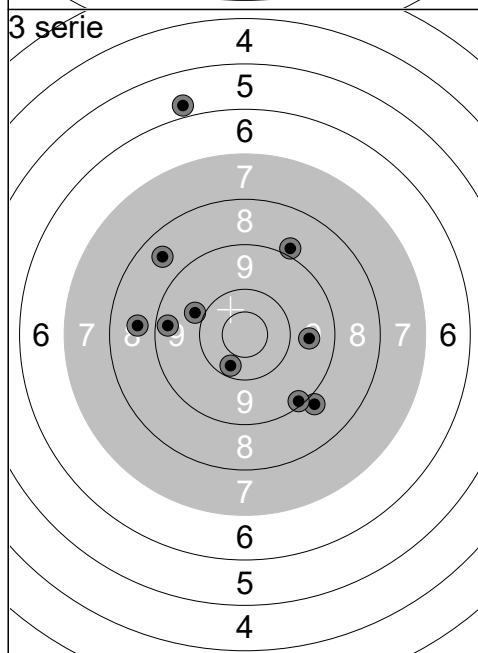

1:	8.9	↘
2:	9.2	↘
3:	8.5	↗
4:	9.6	→
5:	8.9	↗
6:	10.3	↘
7:	8.7	←
8:	9.9	←
9:	5.8	↗
10:	9.3	←
Serie	83	(0x)
Total	252	(2x)

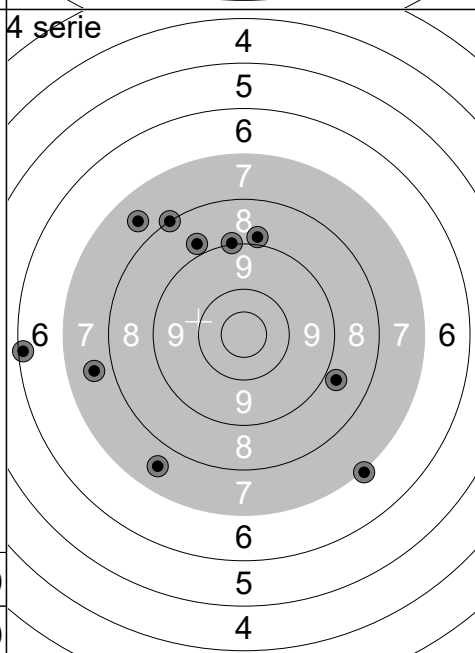

1:	7.0	↘
2:	8.8	↗
3:	7.6	↗
4:	8.1	↗
5:	6.2	←
6:	7.6	↘
7:	9.0	↗
8:	7.7	←
9:	8.9	↗
10:	8.8	↘
Serie	75	(0x)
Total	327	(2x)

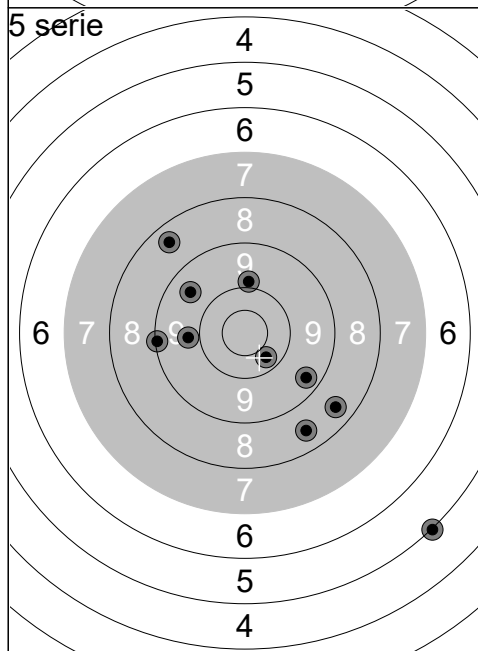

1:	8.5	↘
2:	9.9	↗
3:	9.6	↗
4:	8.5	↘
5:	8.4	↗
6:	9.4	↘
7:	9.8	←
8:	10.3	↘
9:	5.0	↘
10:	9.1	←
Serie	84	(0x)
Total	411	(2x)

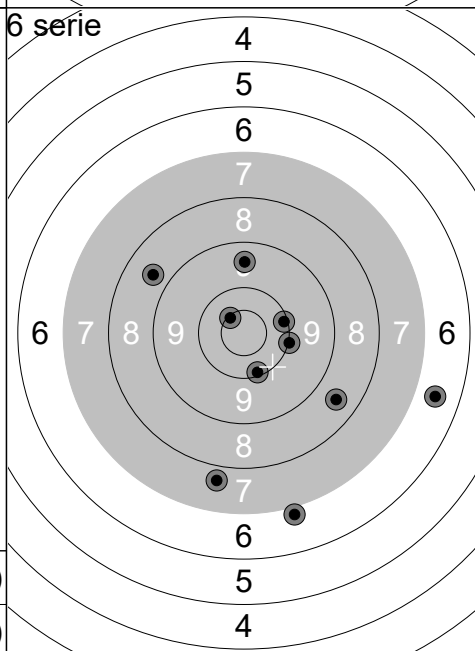

1:	10.1	→
2:	6.9	↓
3:	7.7	↓
4:	6.6	→
5:	8.7	↗
6:	10.0	→
7:	8.5	↘
8:	10.1	↓
9:	10.5x	↗
10:	9.5	↗
Serie	84	(1x)
Total	495	(3x)

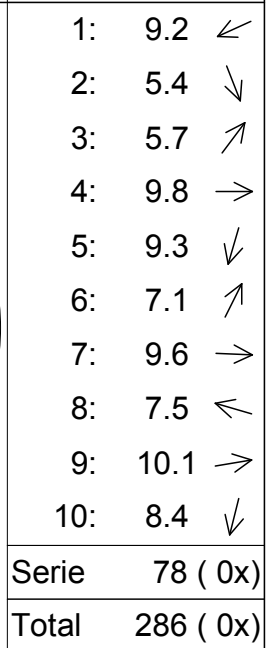
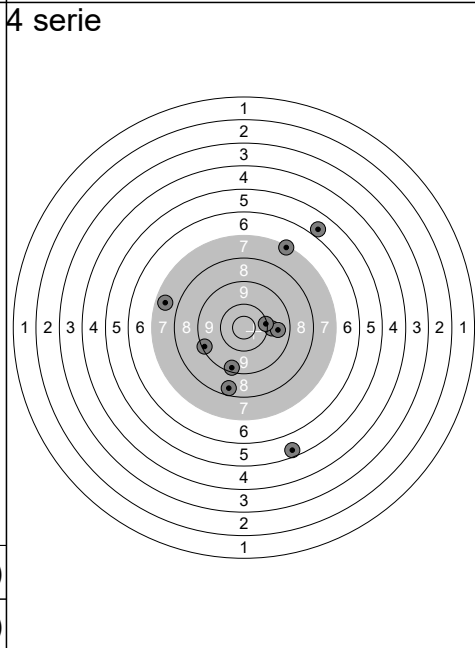
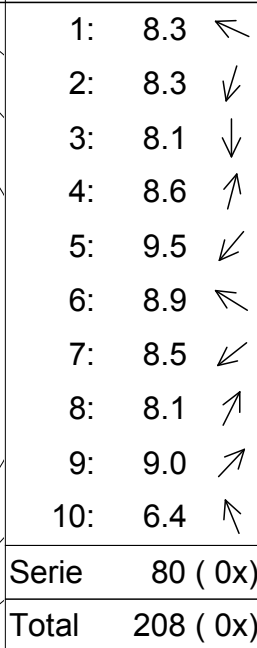
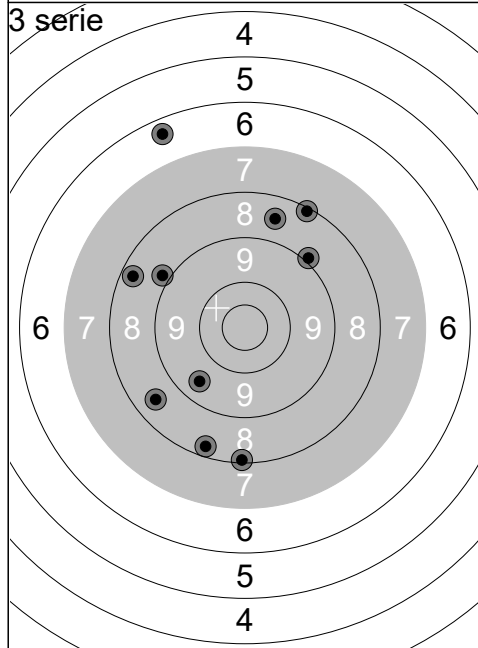
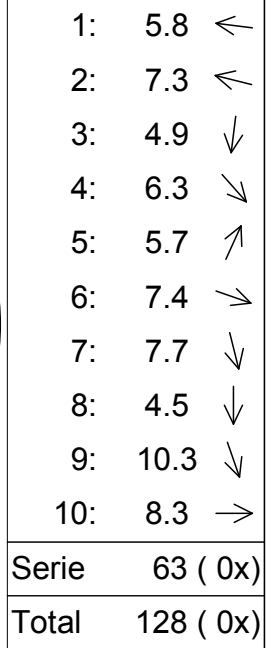
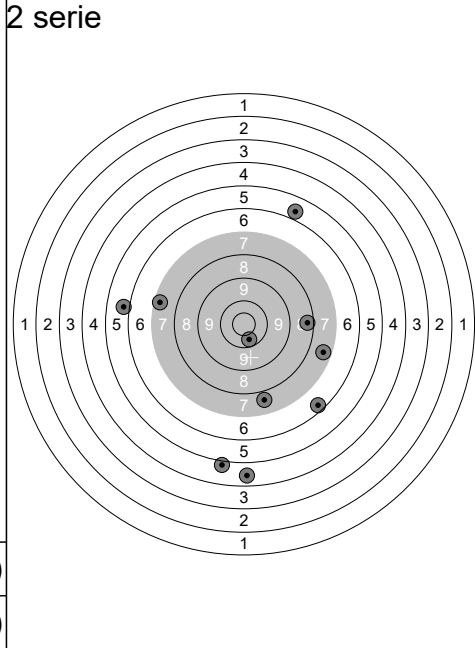
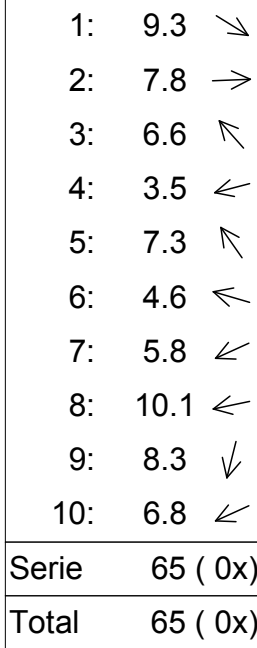
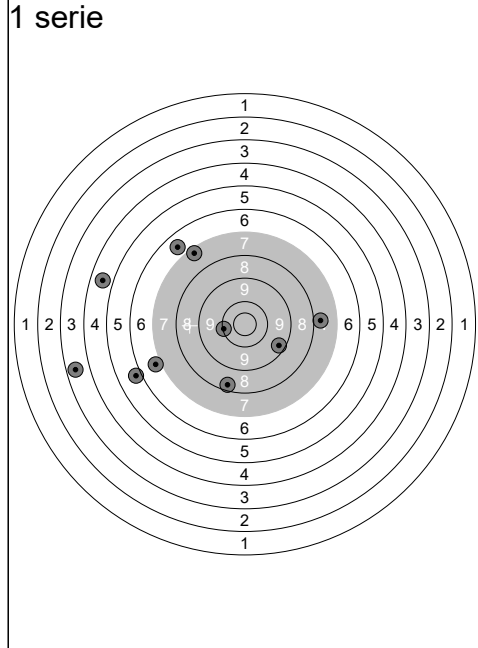

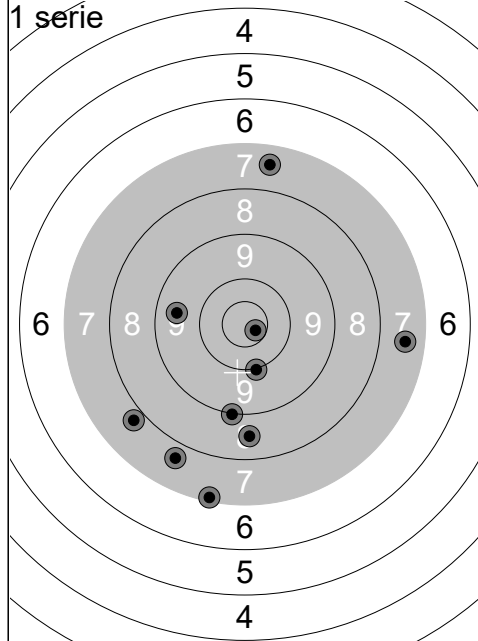

1:	7.5	→
2:	10.0	↓
3:	7.7	↓
4:	7.1	↓
5:	7.5	↑
6:	10.7x	→
7:	8.6	↓
8:	9.5	←
9:	9.0	↓
10:	7.8	↙
Serie	81	(1x)
Total	81	(1x)

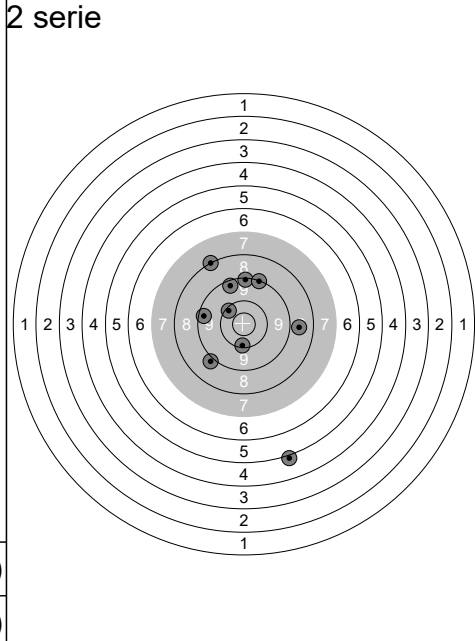

1:	9.3	←
2:	9.1	↑
3:	8.0	↗
4:	10.2	↖
5:	9.1	↑
6:	8.9	↙
7:	9.3	↑
8:	8.7	→
9:	4.9	↓
10:	10.1	↓
Serie	84	(0x)
Total	165	(1x)

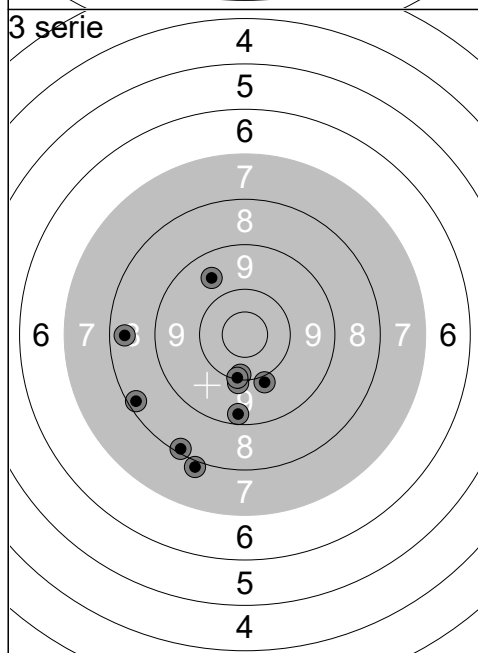

1:	9.6	↖
2:	8.2	↙
3:	9.3	↓
4:	10.2	↓
5:	9.9	↓
6:	8.2	↙
7:	10.0	↓
8:	7.9	↙
9:	8.4	←
10:	10.1	↓
Serie	88	(0x)
Total	253	(1x)

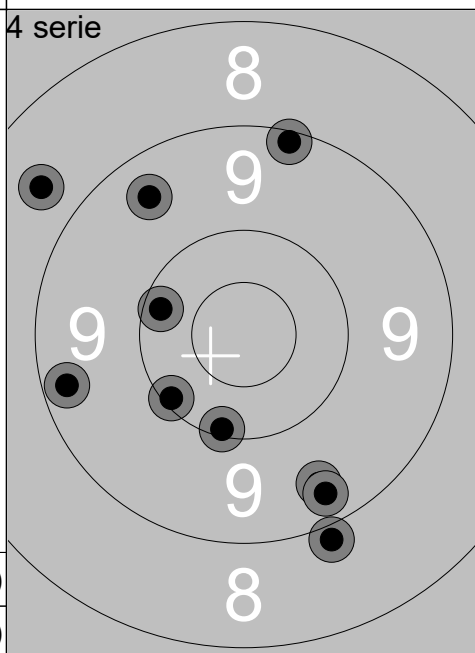

1:	10.1	↙
2:	9.2	↑
3:	8.9	↓
4:	9.3	←
5:	9.5	↗
6:	10.2	←
7:	10.1	↓
8:	9.5	↓
9:	9.3	↙
10:	8.7	↖
Serie	91	(0x)
Total	344	(1x)

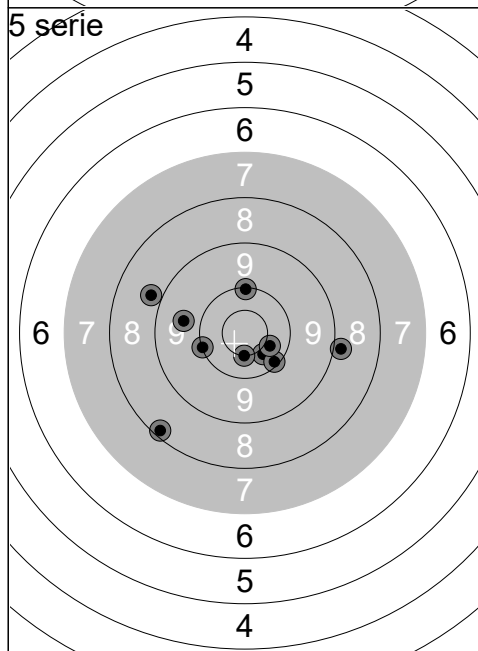

1:	10.4	↙
2:	10.5x	↓
3:	8.8	←
4:	10.1	↙
5:	10.1	↑
6:	8.9	→
7:	9.7	←
8:	8.2	↙
9:	10.1	←
10:	10.4	→
Serie	93	(1x)
Total	437	(2x)

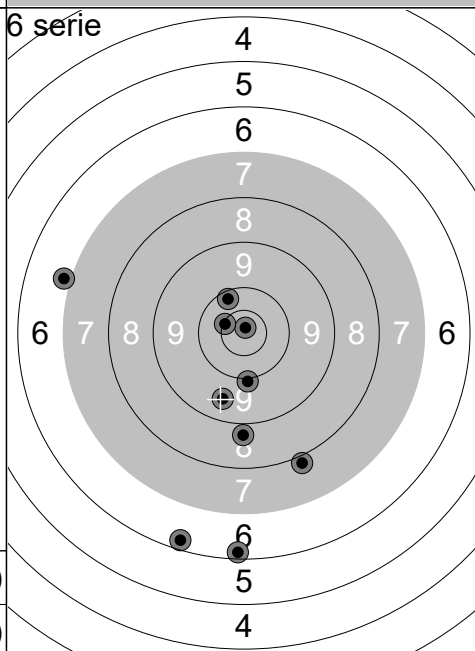

1:	10.8x	↑
2:	7.9	↓
3:	6.3	↓
4:	8.8	↓
5:	10.2	↗
6:	10.0	↓
7:	6.9	←
8:	9.5	↓
9:	10.5x	↖
10:	6.2	↓
Serie	82	(2x)
Total	519	(4x)

1 serie

1:	7.9	↓
2:	7.6	↓
3:	10.7x	→
4:	9.0	↓
5:	9.0	↑
6:	6.7	←
7:	4.5	↓
8:	8.5	↓
9:	7.0	↑
10:	6.1	↗
Serie	73	(1x)
Total	73	(1x)

2 serie

1:	9.8	→
2:	2.3	↑
3:	9.0	↓
4:	7.8	↘
5:	7.1	↘
6:	6.6	↗
7:	8.7	↘
8:	8.1	→
9:	9.1	↓
10:	8.5	↓
Serie	73	(0x)
Total	146	(1x)

3 serie

1:	8.9	→
2:	8.4	↗
3:	5.6	↑
4:	9.1	↑
5:	5.2	↗
6:	7.3	→
7:	5.8	→
8:	8.1	↗
9:	10.2	↗
10:	8.8	→
Serie	73	(0x)
Total	219	(1x)

4 serie

1:	9.0	→
2:	9.9	↗
3:	9.5	↑
4:	9.4	→
5:	4.7	↓
6:	7.8	↑
7:	7.6	→
8:	9.4	↘
9:	5.7	↑
10:	6.8	↗
Serie	74	(0x)
Total	293	(1x)

5 serie

1:	10.7x	←
2:	6.8	←
3:	7.2	↑
4:	5.9	↑
5:	7.6	↘
6:	9.5	←
7:	8.1	↓
8:	7.7	↗
9:	10.5x	↘
10:	9.0	↘
Serie	78	(2x)
Total	371	(3x)

6 serie

1:	8.6	←
2:	8.6	↘
3:	10.4	↘
4:	6.2	↑
5:	8.3	←
6:	2.6	↗
7:	8.7	→
8:	8.1	↘
9:	9.0	↓
10:	9.3	↗
Serie	76	(0x)
Total	447	(3x)

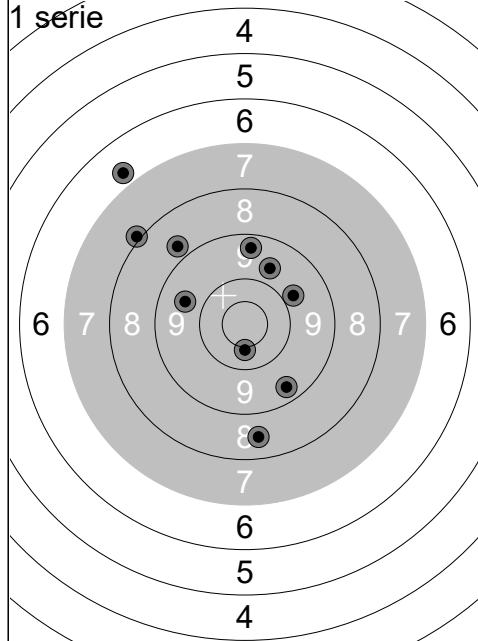

1:	6.8	↗
2:	8.8	↗
3:	9.7	↗
4:	8.0	↖
5:	9.4	↑
6:	9.8	↗
7:	10.4x	↓
8:	8.5	↓
9:	9.4	↓
10:	9.6	←
Serie	85 (1x)	
Total	85 (1x)	

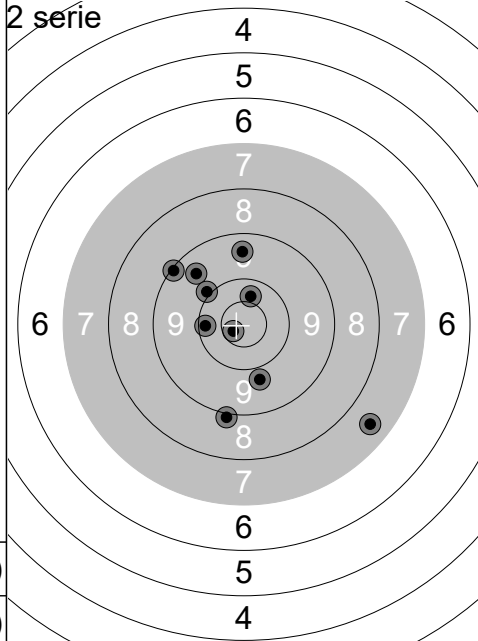

1:	9.0	↓
2:	9.5	↖
3:	9.4	↑
4:	10.4	↑
5:	10.0	↖
6:	7.5	↘
7:	10.7x	↙
8:	9.1	↖
9:	9.8	↓
10:	10.2	←
Serie	92 (1x)	
Total	177 (2x)	

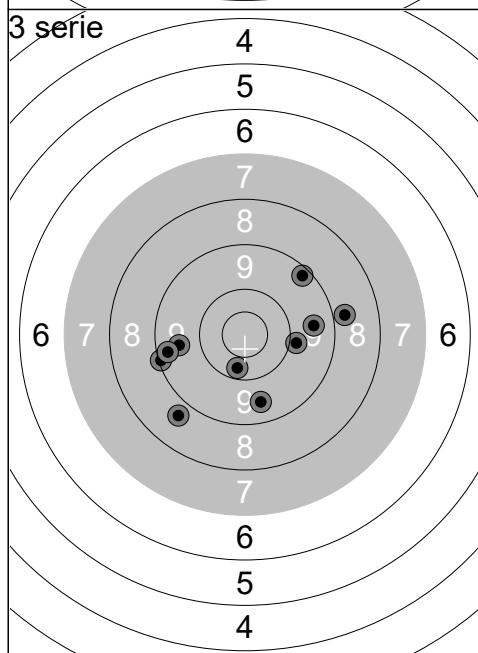

1:	9.9	→
2:	8.7	↘
3:	9.2	↗
4:	9.6	←
5:	8.8	→
6:	9.1	←
7:	9.3	←
8:	9.5	↓
9:	10.3	↓
10:	9.5	→
Serie	89 (0x)	
Total	266 (2x)	

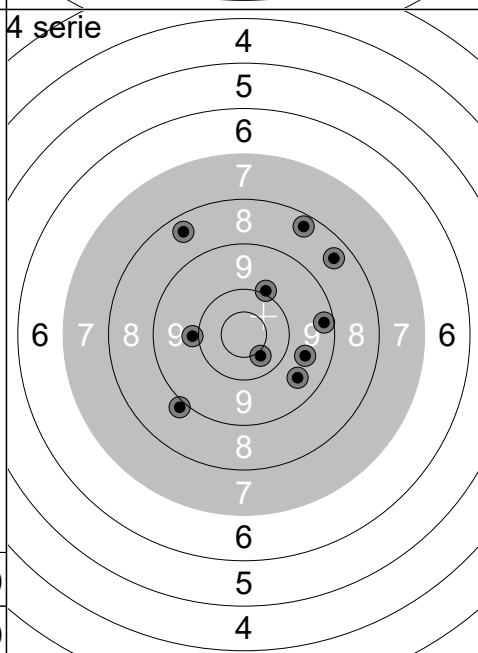

1:	8.9	↘
2:	8.4	↗
3:	8.3	↗
4:	10.4x	↓
5:	9.3	→
6:	9.9	←
7:	9.5	↘
8:	9.6	→
9:	8.4	↗
10:	10.0	↗
Serie	88 (1x)	
Total	354 (3x)	

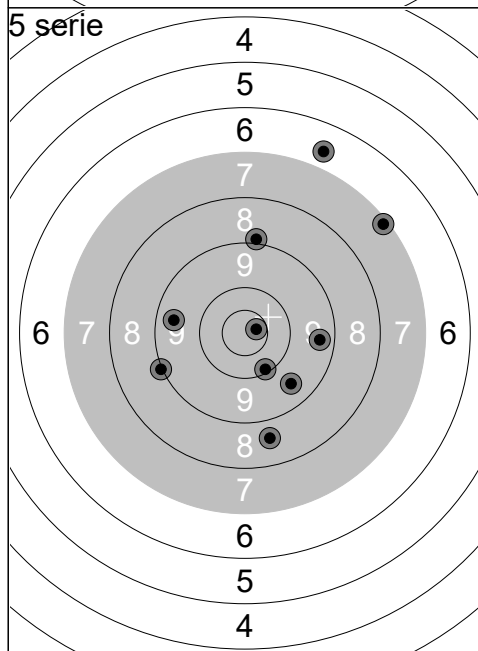

1:	9.0	←
2:	9.5	←
3:	9.0	↑
4:	9.5	↘
5:	10.1	↘
6:	7.2	↗
7:	6.7	↗
8:	8.7	↓
9:	10.7x	→
10:	9.4	→
Serie	86 (1x)	
Total	440 (4x)	

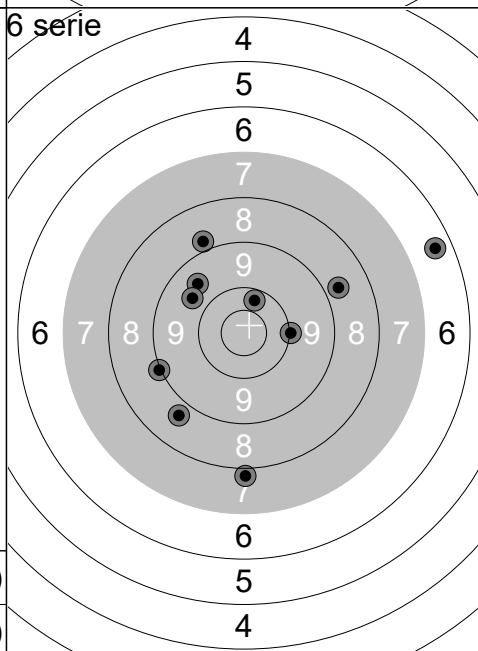

1:	9.6	↖
2:	6.4	↗
3:	10.3	↗
4:	10.0	→
5:	9.0	←
6:	9.7	↖
7:	8.8	↗
8:	7.9	↓
9:	8.7	↗
10:	8.7	↘
Serie	84 (0x)	
Total	524 (4x)	

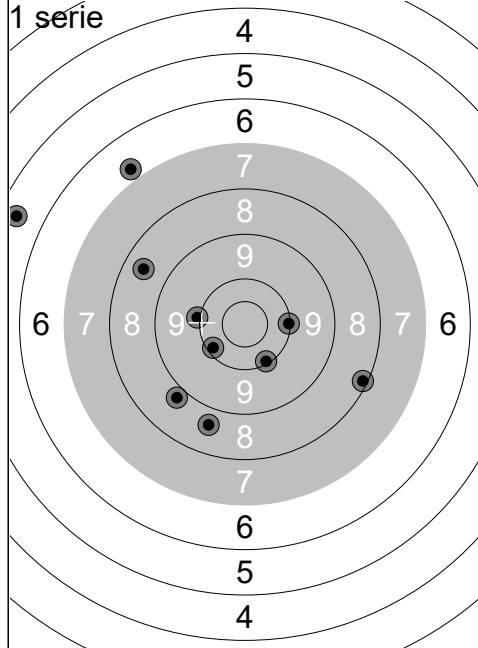

1:	8.5	↖
2:	5.5	↖
3:	6.8	↗
4:	10.1	→
5:	10.2	↙
6:	8.7	↓
7:	10.1	↓
8:	8.2	↘
9:	8.8	↙
10:	10.0	←
Serie	83	(0x)
Total	83	(0x)

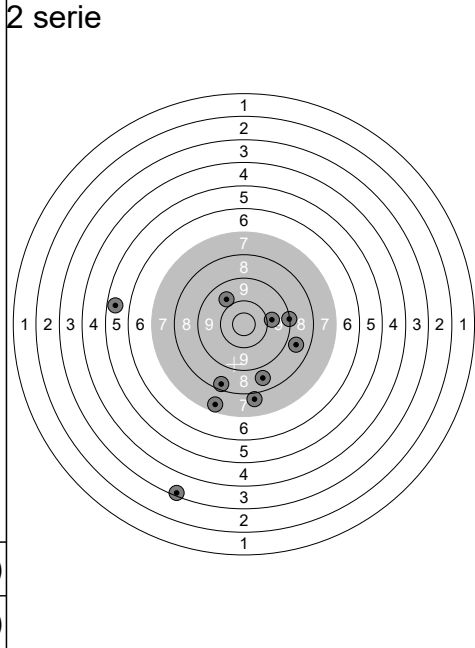

1:	5.4	↖
2:	7.8	↓
3:	9.1	→
4:	8.6	↓
5:	8.3	↓
6:	9.8	→
7:	3.2	↓
8:	8.6	↘
9:	7.4	↓
10:	9.7	↗
Serie	73	(0x)
Total	156	(0x)

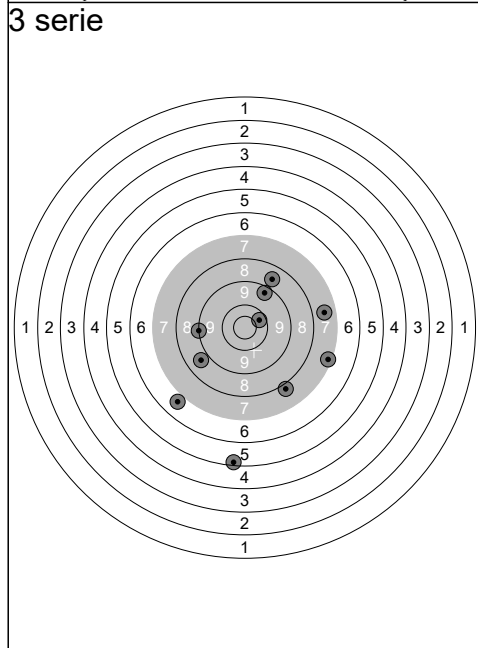

1:	8.6	↗
2:	9.1	←
3:	9.3	↗
4:	8.7	←
5:	6.7	↙
6:	7.9	↓
7:	7.2	↘
8:	7.6	→
9:	5.2	↓
10:	10.3	↗
Serie	76	(0x)
Total	232	(0x)

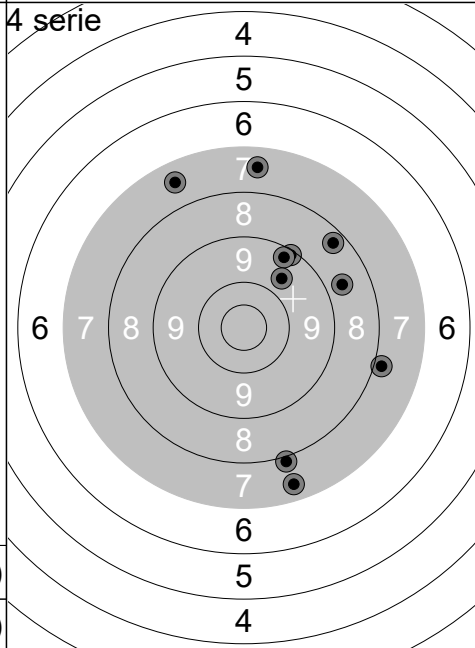

1:	8.0	↓
2:	9.1	↗
3:	7.4	↓
4:	9.3	↗
5:	7.5	↑
6:	8.7	→
7:	8.3	↗
8:	7.5	↗
9:	9.7	↗
10:	7.9	→
Serie	79	(0x)
Total	311	(0x)

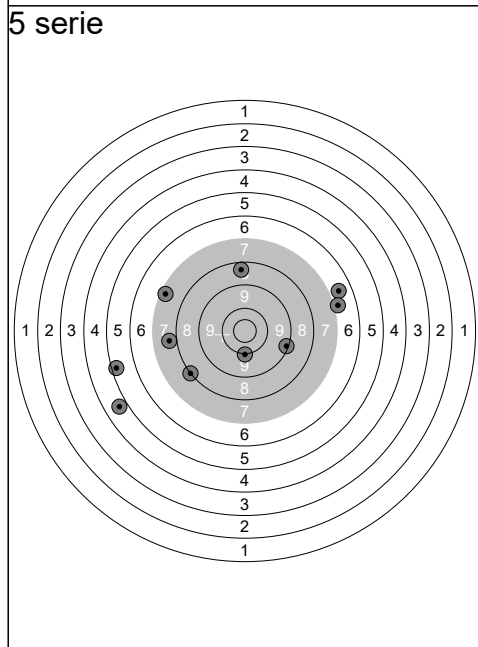

1:	8.4	↑
2:	6.6	→
3:	8.0	↙
4:	9.1	↘
5:	10.0	↓
6:	4.7	↙
7:	7.2	↖
8:	5.2	←
9:	7.7	←
10:	6.9	→
Serie	70	(0x)
Total	381	(0x)

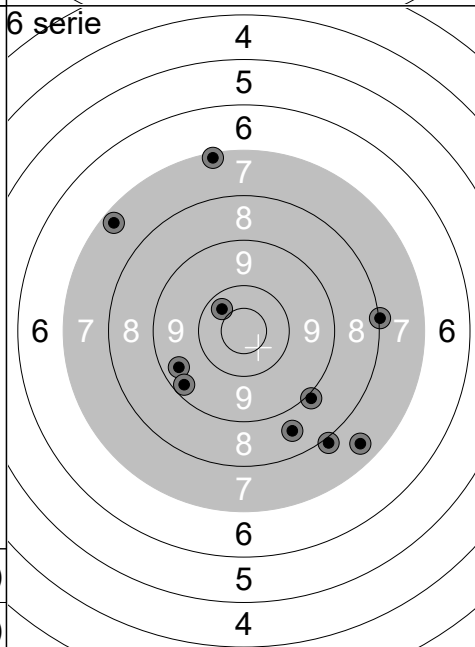

1:	7.2	↑
2:	9.4	↙
3:	7.9	↓
4:	9.0	↓
5:	7.5	↙
6:	9.3	↙
7:	10.3	↗
8:	8.0	→
9:	7.3	↗
10:	8.6	↓
Serie	81	(0x)
Total	462	(0x)

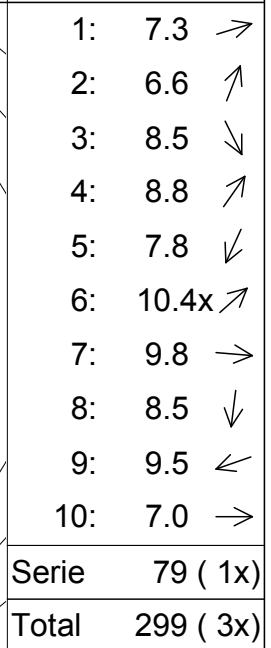
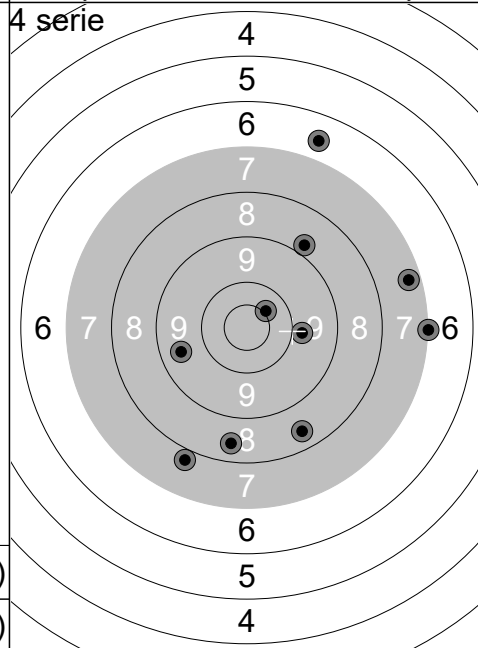
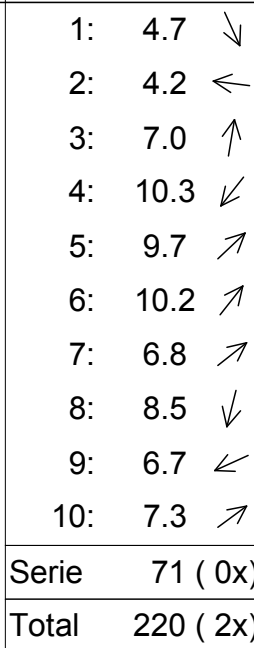
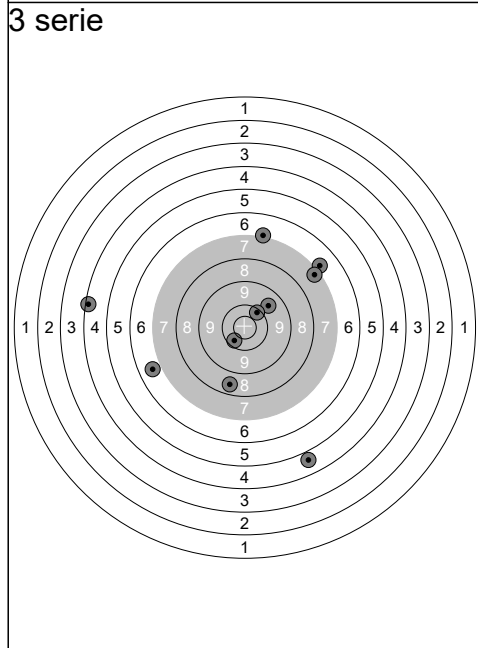
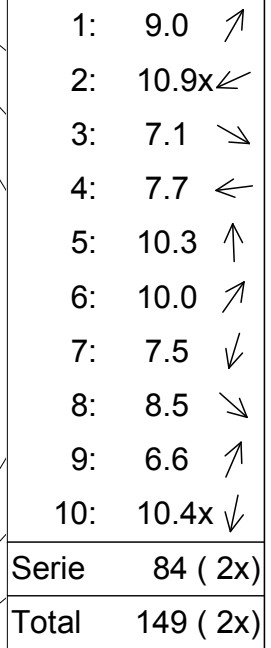
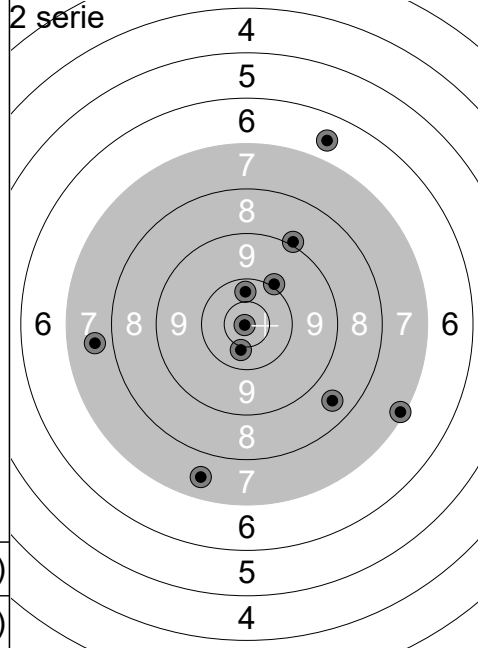
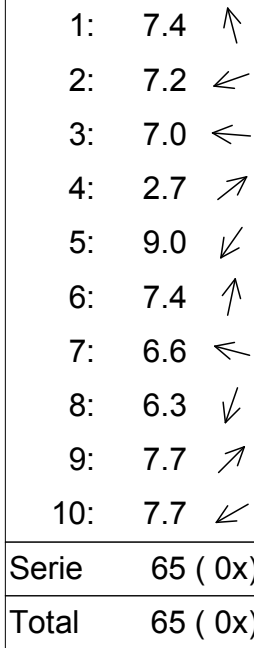
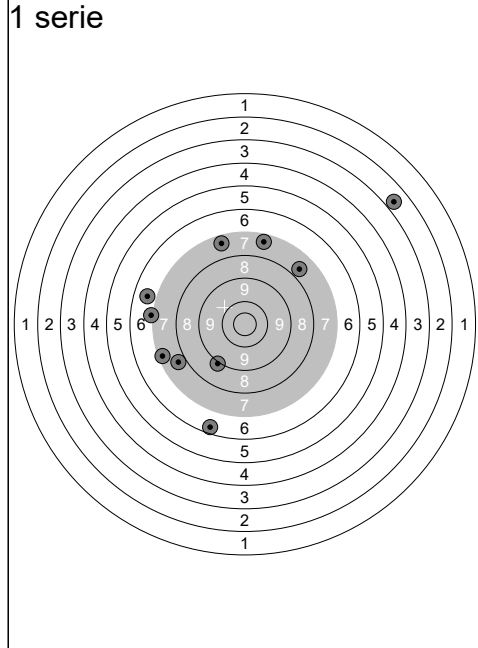

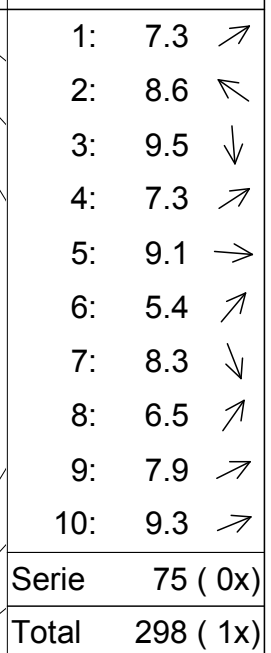
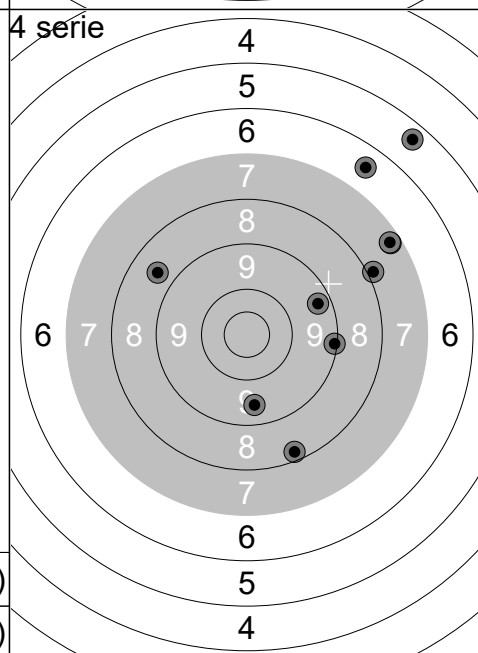
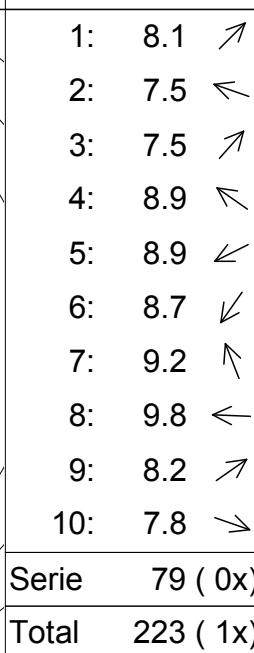
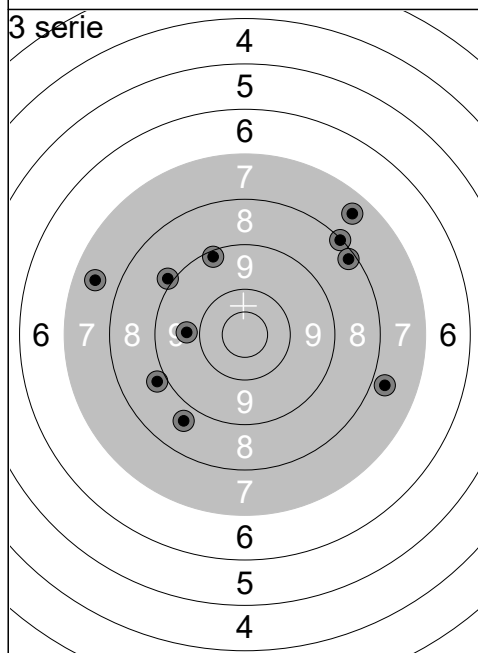
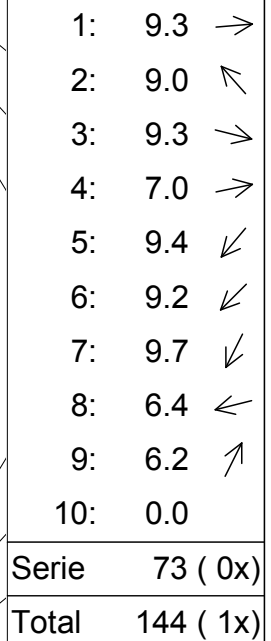
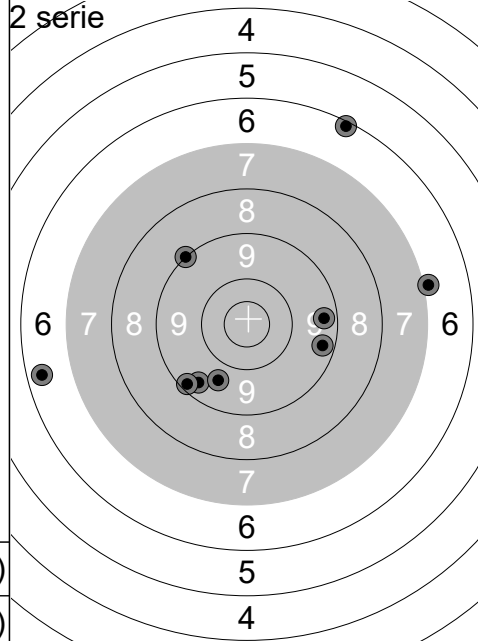
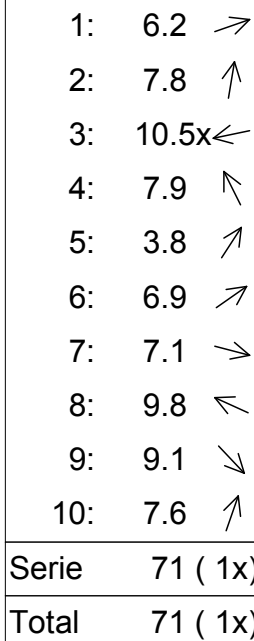
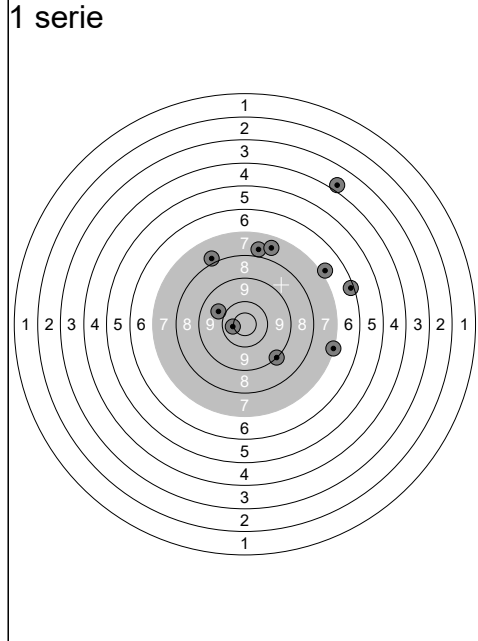

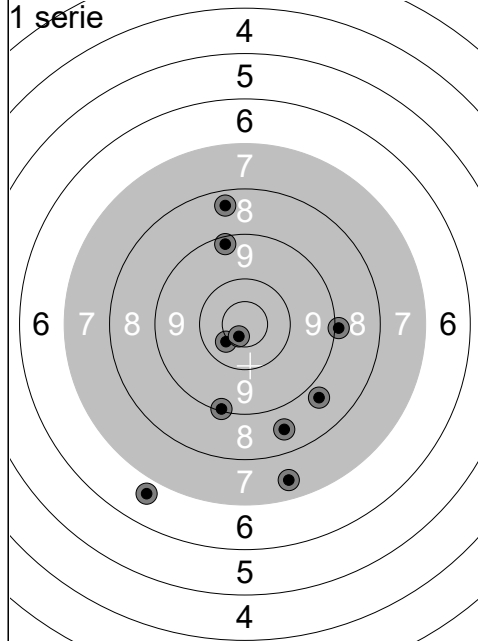

1:	6.7	↘
2:	9.2	↑
3:	8.6	↘
4:	8.4	↑
5:	7.5	↘
6:	9.1	↘
7:	10.4x	↙
8:	10.7x	↘
9:	9.0	→
10:	8.8	↘
Serie	84	(2x)
Total	84	(2x)

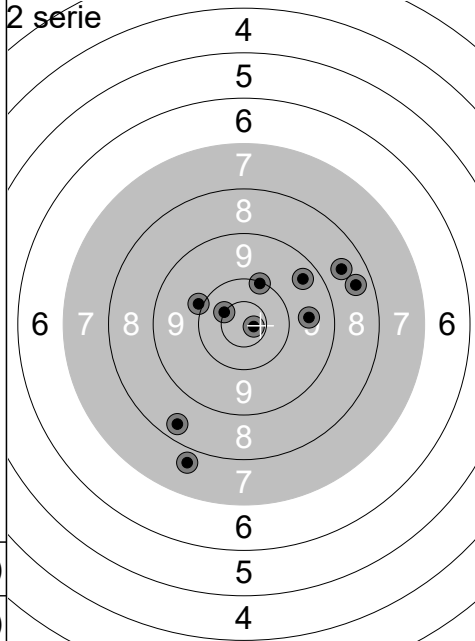

1:	8.4	→
2:	10.1	↑
3:	9.6	→
4:	10.0	↙
5:	9.4	↗
6:	7.8	↘
7:	10.5x	↙
8:	8.6	↗
9:	8.4	↘
10:	10.7x	→
Serie	89	(2x)
Total	173	(4x)

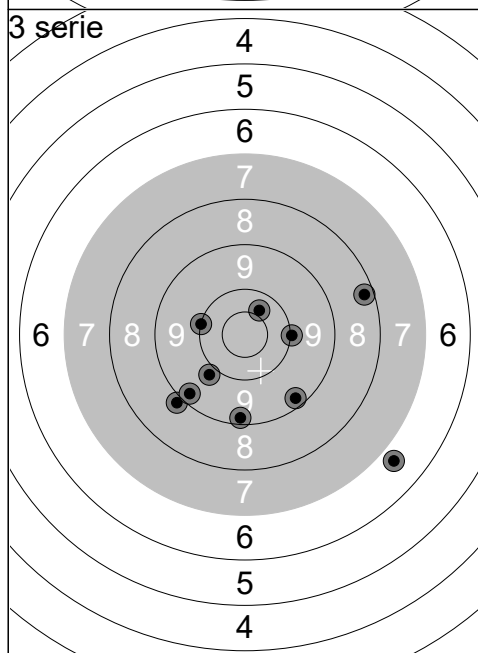

1:	10.4	↗
2:	8.3	→
3:	9.9	↘
4:	10.0	↙
5:	10.0	→
6:	9.3	↘
7:	8.9	↘
8:	9.2	↘
9:	9.3	↘
10:	6.7	↘
Serie	88	(0x)
Total	261	(4x)

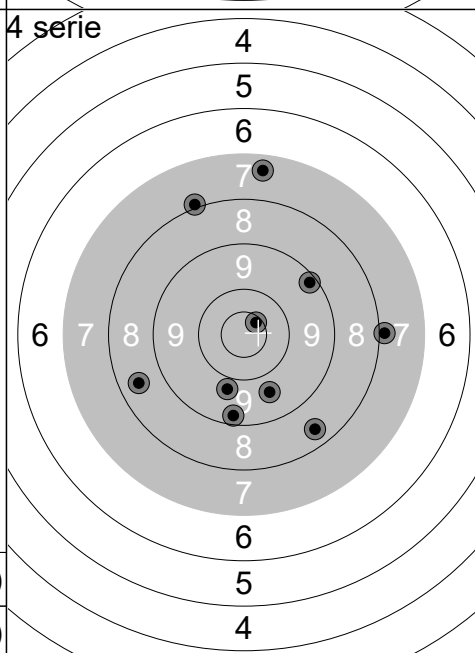

1:	9.3	↘
2:	9.7	↘
3:	9.8	↘
4:	9.2	↗
5:	7.4	↑
6:	7.9	→
7:	8.5	↙
8:	8.0	↑
9:	10.6x	↗
10:	8.5	↘
Serie	84	(1x)
Total	345	(5x)

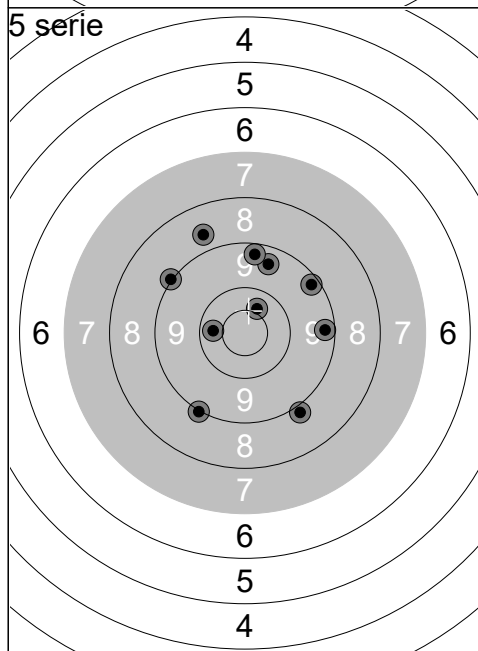

1:	9.4	↑
2:	9.3	→
3:	10.3	↙
4:	8.9	↘
5:	9.0	↘
6:	9.3	↑
7:	10.4x	↗
8:	9.2	↗
9:	8.7	↑
10:	9.0	↙
Serie	90	(1x)
Total	435	(6x)

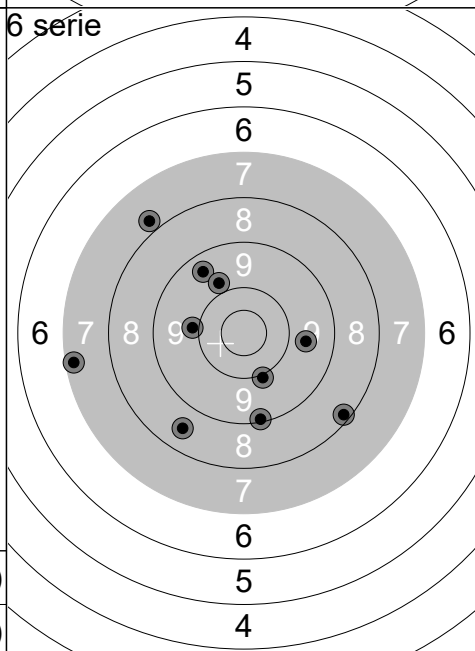

1:	9.4	↗
2:	9.7	→
3:	9.9	↙
4:	9.8	↑
5:	7.8	↗
6:	7.2	↙
7:	8.2	↘
8:	10.0	↘
9:	8.6	↘
10:	9.1	↘
Serie	85	(0x)
Total	520	(6x)

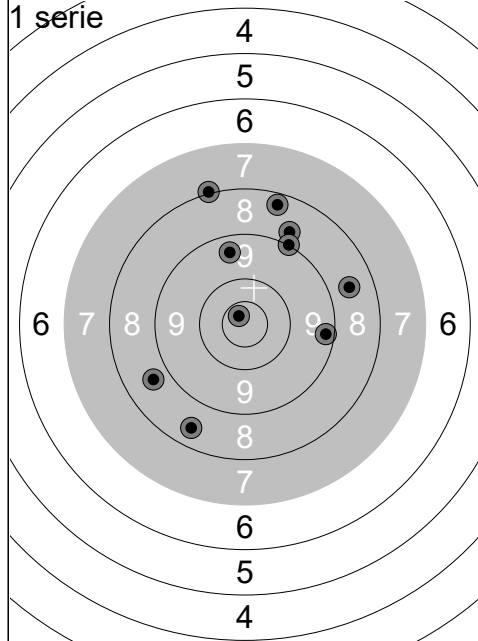

1:	8.5	↘
2:	8.7	←
3:	9.4	↑
4:	8.8	↗
5:	10.7x	↖
6:	8.3	↑
7:	8.0	↑
8:	8.6	→
9:	9.1	↗
10:	9.3	→
Serie	85 (1x)	
Total	85 (1x)	

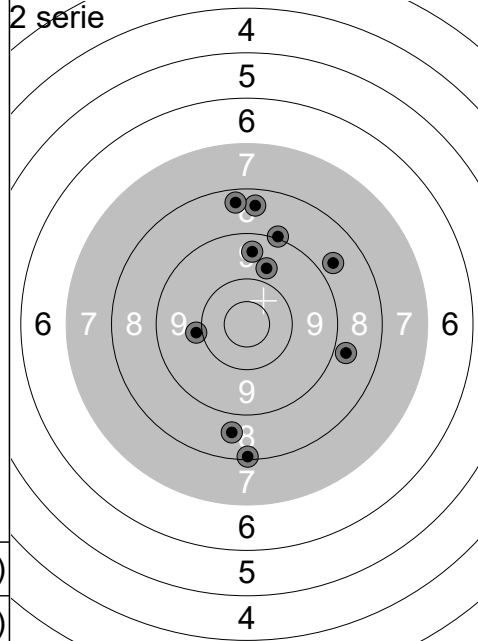

1:	8.4	↑
2:	9.9	←
3:	8.4	↑
4:	9.4	↑
5:	9.0	↑
6:	9.7	↗
7:	8.7	↗
8:	8.1	↓
9:	8.8	→
10:	8.6	↓
Serie	84 (0x)	
Total	169 (1x)	

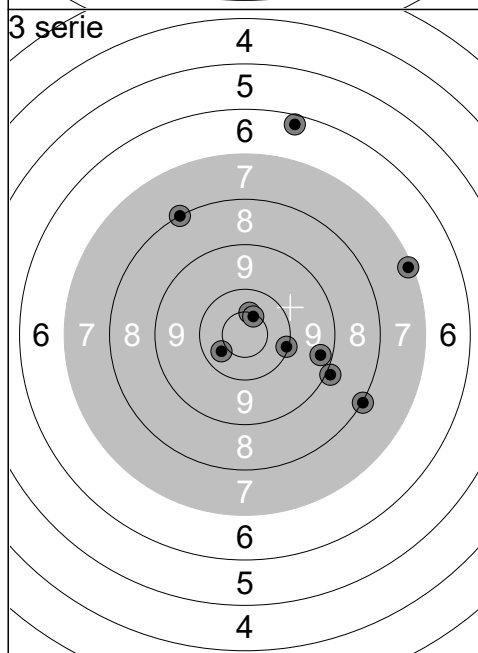

1:	10.1	→
2:	9.0	→
3:	8.1	↗
4:	7.2	→
5:	10.5x	↑
6:	10.5x	↗
7:	10.4	←
8:	9.3	→
9:	8.0	↘
10:	6.3	↑
Serie	87 (2x)	
Total	256 (3x)	

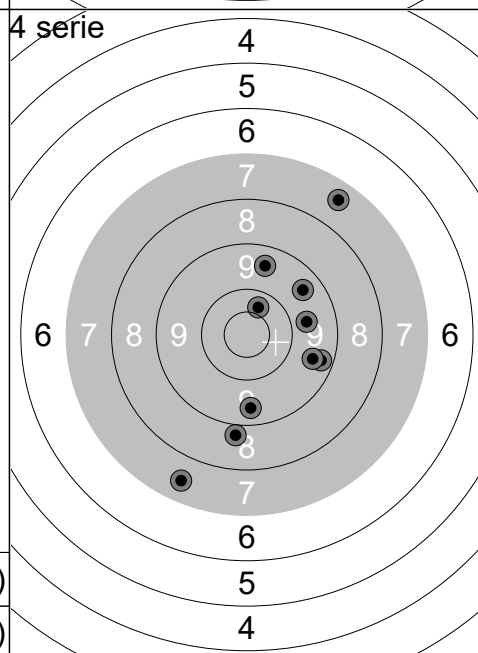

1:	8.8	↓
2:	9.3	→
3:	7.5	↗
4:	9.7	→
5:	9.4	↓
6:	9.5	↗
7:	9.5	→
8:	7.5	↓
9:	10.4	↑
10:	9.5	↑
Serie	86 (0x)	
Total	342 (3x)	

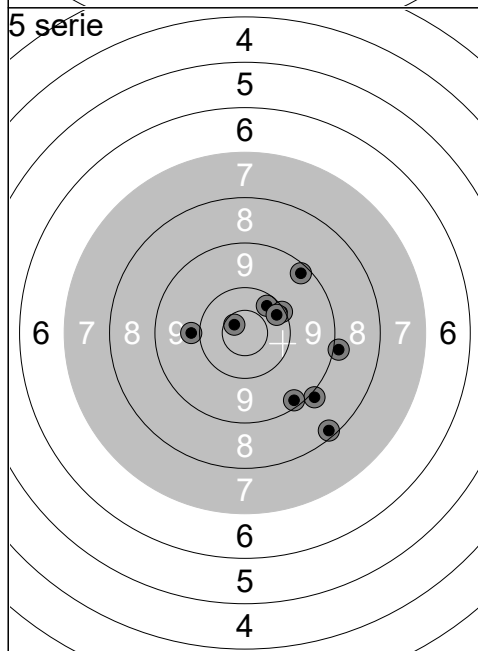

1:	9.0	↘
2:	9.9	←
3:	10.3	↗
4:	9.3	↗
5:	10.7x	↖
6:	8.2	↘
7:	9.2	↘
8:	8.9	→
9:	10.1	↗
10:	10.2	↗
Serie	92 (1x)	
Total	434 (4x)	

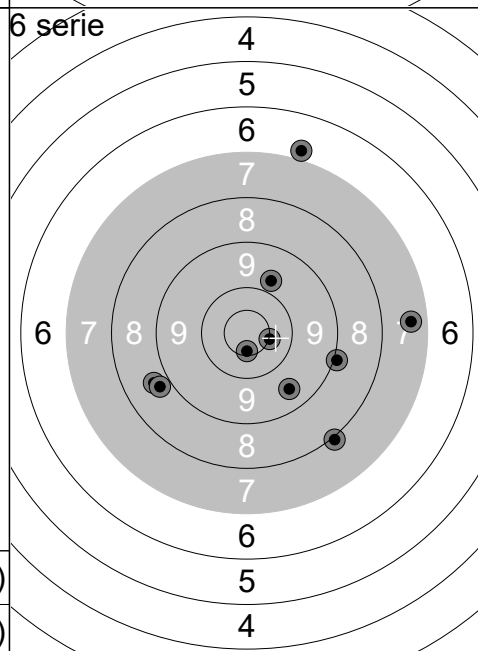

1:	9.8	↗
2:	8.7	←
3:	9.5	↘
4:	8.0	↘
5:	10.6x	↓
6:	9.0	→
7:	8.8	←
8:	7.4	→
9:	10.5x	→
10:	6.8	↑
Serie	84 (2x)	
Total	518 (6x)	

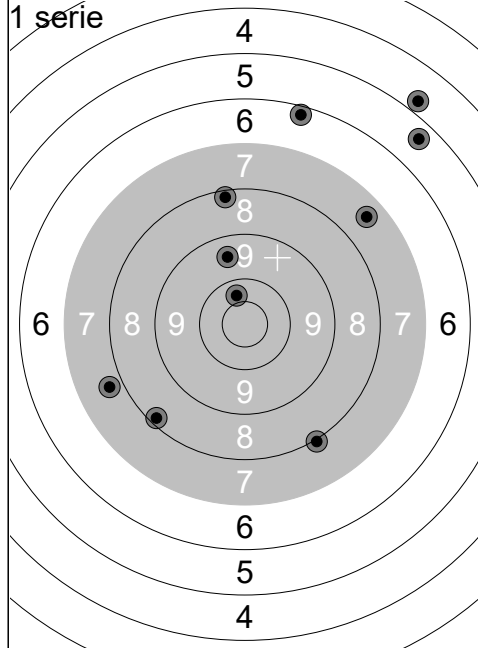

1:	9.5	↑
2:	8.2	↙
3:	4.8	↗
4:	6.3	↑
5:	10.3	↑
6:	7.8	↙
7:	8.2	↑
8:	8.0	↘
9:	7.5	↗
10:	5.4	↗
Serie	72 (0x)	
Total	72 (0x)	

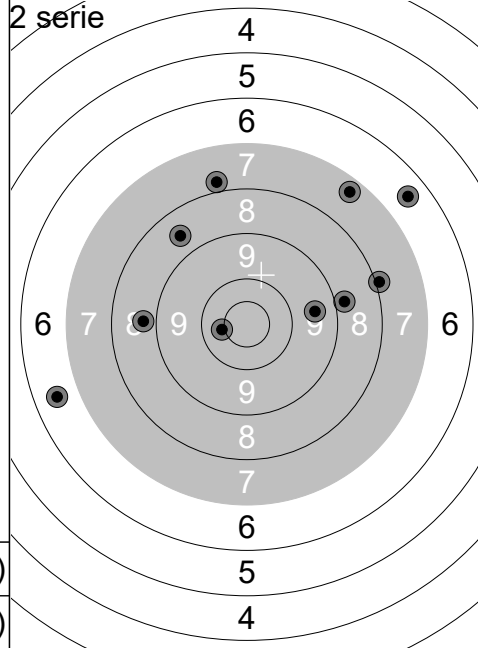

1:	7.9	↑
2:	9.5	→
3:	6.6	↙
4:	8.6	↖
5:	8.0	→
6:	6.5	↗
7:	8.8	→
8:	8.8	↙
9:	10.4x	↙
10:	7.4	↗
Serie	77 (1x)	
Total	149 (1x)	

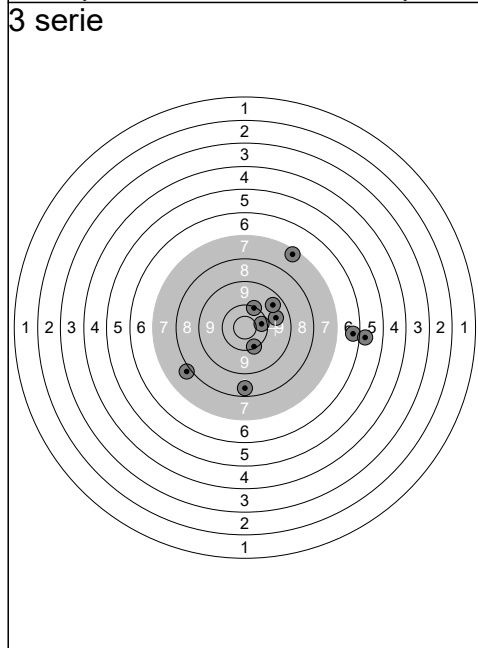

1:	10.3	→
2:	8.4	↓
3:	10.1	↓
4:	7.9	↙
5:	7.3	↗
6:	6.4	→
7:	5.8	→
8:	9.7	→
9:	9.5	↗
10:	10.1	↗
Serie	81 (0x)	
Total	230 (1x)	

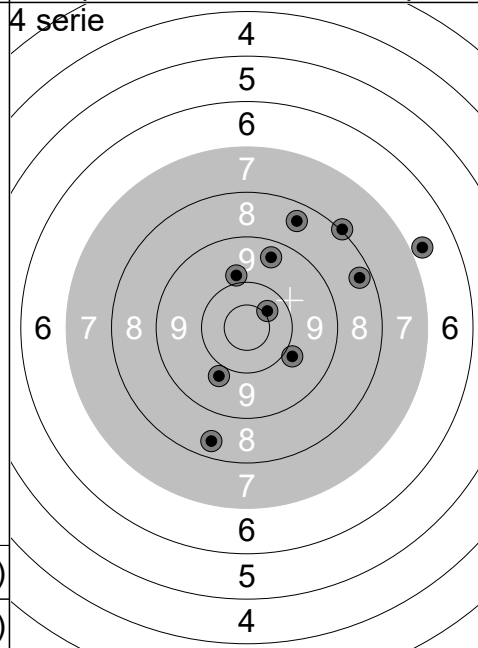

1:	10.4x	↗
2:	8.4	↓
3:	9.8	↓
4:	9.9	↘
5:	8.5	↗
6:	9.9	↑
7:	6.8	↗
8:	8.3	↗
9:	8.0	↗
10:	9.4	↗
Serie	84 (1x)	
Total	314 (2x)	

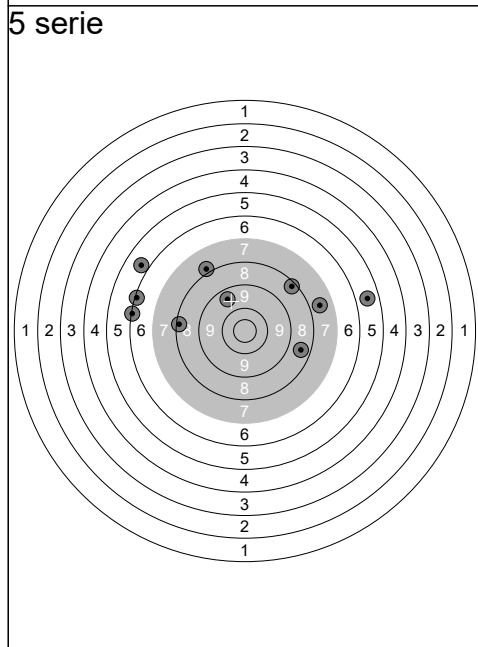

1:	5.8	↖
2:	6.2	↙
3:	8.5	→
4:	7.9	↗
5:	6.1	↙
6:	9.5	↗
7:	7.6	→
8:	8.2	↙
9:	8.2	↗
10:	5.5	→
Serie	69 (0x)	
Total	383 (2x)	

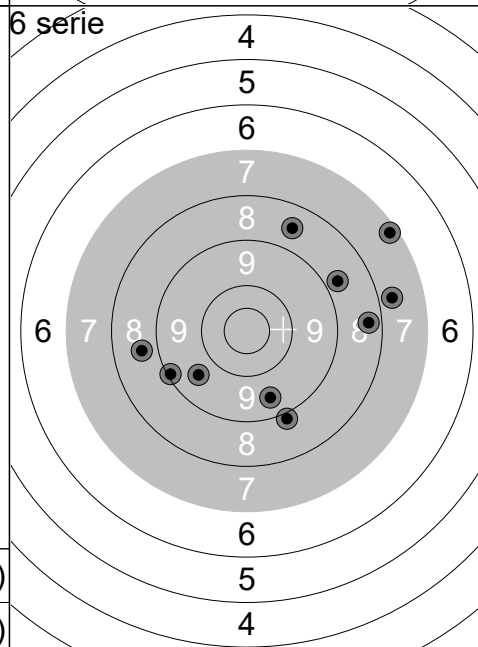

1:	8.7	↙
2:	9.1	↙
3:	8.4	→
4:	8.8	↗
5:	7.8	→
6:	7.2	↗
7:	8.9	↓
8:	9.6	↙
9:	8.6	↗
10:	9.5	↓
Serie	81 (0x)	
Total	464 (2x)	

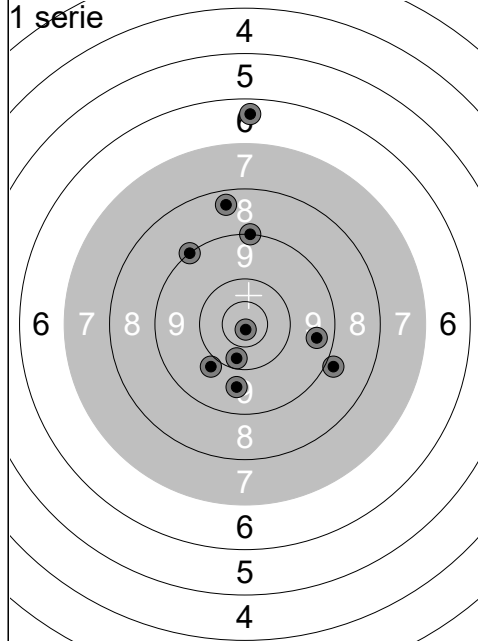

1:	10.8x ↓
2:	9.9 ↙
3:	8.9 →
4:	9.7 ↓
5:	9.4 →
6:	10.2 ↓
7:	6.4 ↑
8:	8.4 ↑
9:	9.1 ↖
10:	9.1 ↑
Serie	87 (1x)
Total	87 (1x)

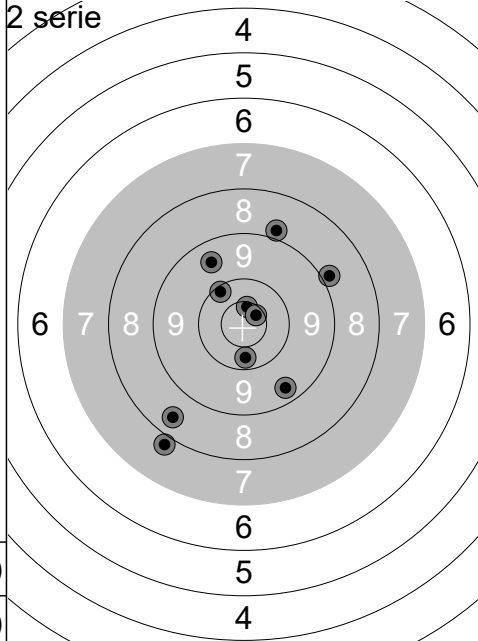

1:	7.9 ↘
2:	9.4 ↘
3:	8.5 ↘
4:	10.6x ↑
5:	8.9 ↑
6:	10.6x ↗
7:	10.2 ↖
8:	9.5 ↖
9:	10.3 ↓
10:	8.9 ↗
Serie	89 (2x)
Total	176 (3x)

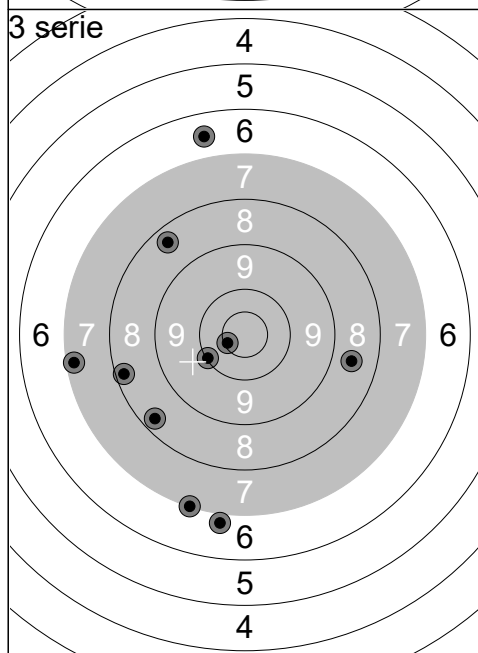

1:	7.1 ↓
2:	10.6x ↙
3:	8.6 →
4:	7.2 ←
5:	6.6 ↑
6:	10.1 ↙
7:	8.4 ↖
8:	8.3 ↙
9:	8.2 ←
10:	6.8 ↓
Serie	78 (1x)
Total	254 (4x)

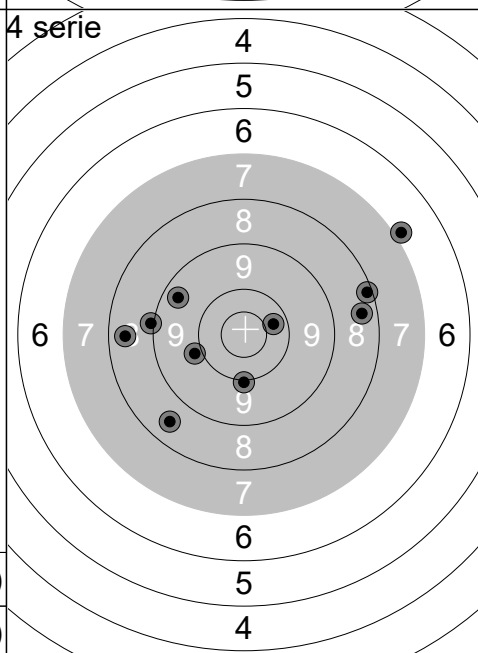

1:	8.4 ←
2:	9.4 ↖
3:	6.9 ↗
4:	10.0 ↓
5:	8.2 →
6:	9.0 ←
7:	8.5 ↘
8:	10.3 →
9:	9.9 ←
10:	8.4 →
Serie	85 (0x)
Total	339 (4x)

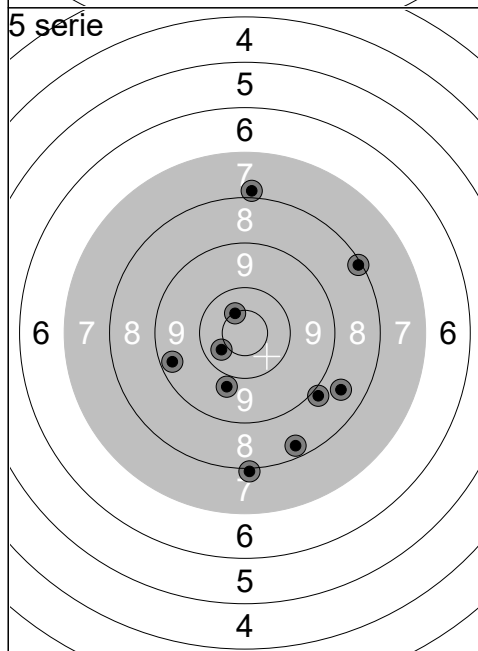

1:	7.9 ↑
2:	8.1 ↗
3:	8.6 ↘
4:	9.8 ↓
5:	8.9 ↘
6:	8.0 ↓
7:	10.4 ↙
8:	10.5x ↖
9:	9.3 ←
10:	8.3 ↓
Serie	85 (1x)
Total	424 (5x)

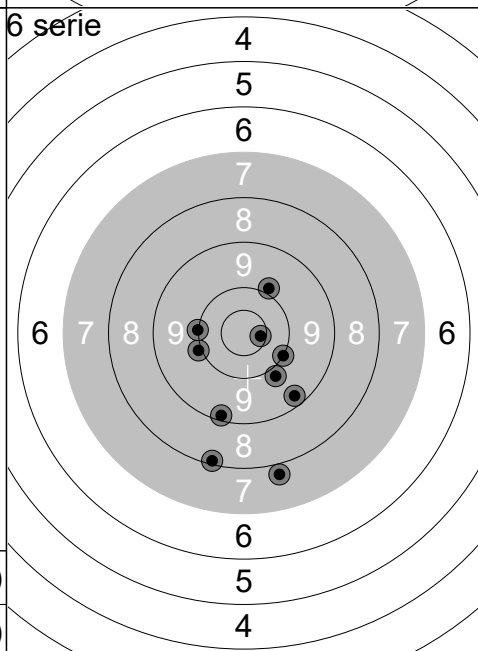

1:	10.0 ↘
2:	7.8 ↓
3:	10.0 ←
4:	9.9 ↗
5:	10.6x →
6:	9.2 ↓
7:	10.0 ←
8:	9.3 ↘
9:	8.2 ↓
10:	9.9 ↘
Serie	91 (1x)
Total	515 (6x)

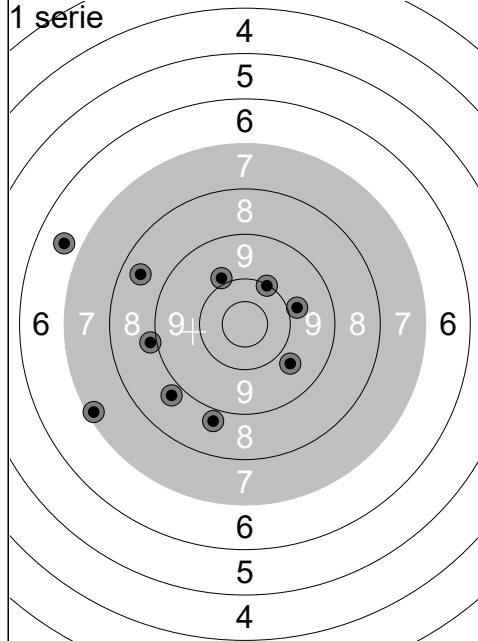

1:	8.9	←
2:	7.2	←
3:	6.7	←
4:	8.8	↓
5:	10.1	↗
6:	9.7	↓
7:	8.8	←
8:	9.8	→
9:	8.5	←
10:	9.9	↗
Serie	82 (0x)	
Total	82 (0x)	

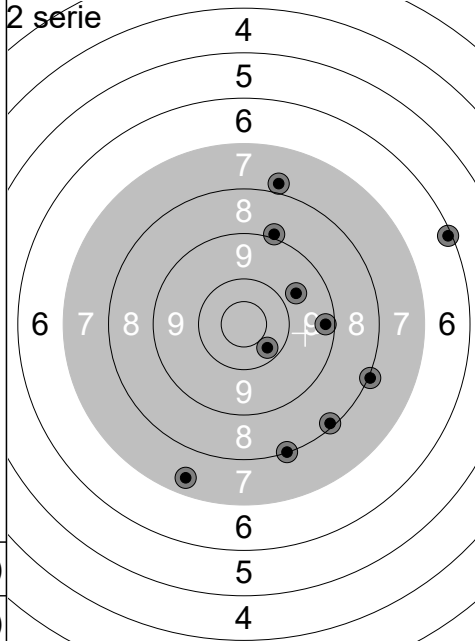

1:	10.3	↘
2:	9.2	→
3:	8.1	↓
4:	9.0	↗
5:	7.9	↗
6:	7.4	↓
7:	9.7	↗
8:	8.0	→
9:	6.1	↗
10:	8.2	↘
Serie	81 (0x)	
Total	163 (0x)	

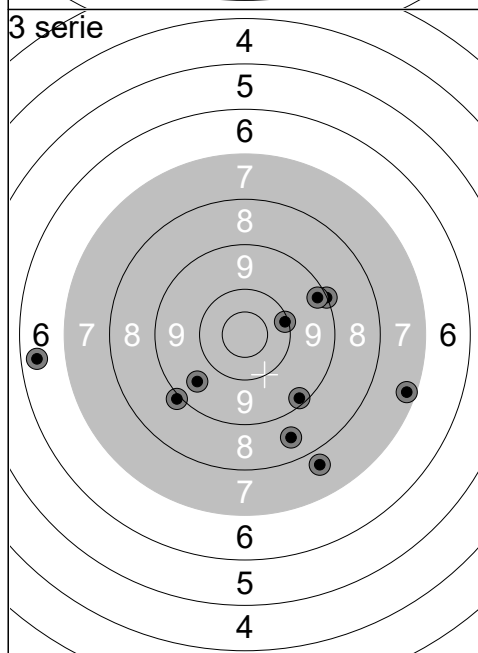

1:	8.6	↘
2:	9.0	←
3:	7.7	↘
4:	7.3	→
5:	9.2	↘
6:	6.4	←
7:	9.6	↘
8:	9.1	↗
9:	9.2	↗
10:	10.1	→
Serie	83 (0x)	
Total	246 (0x)	

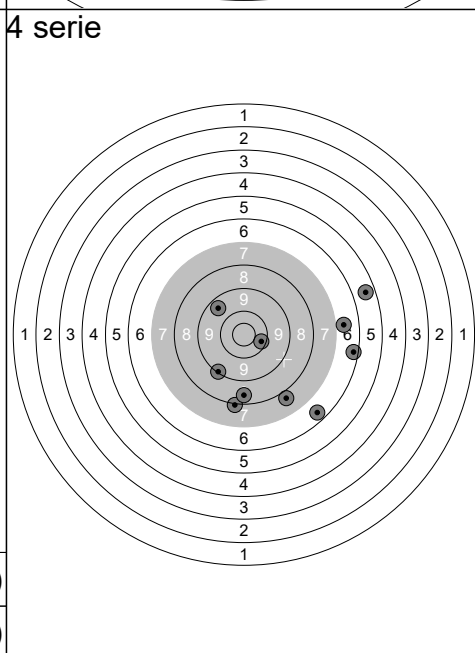

1:	7.8	↘
2:	9.1	↘
3:	6.2	→
4:	5.5	→
5:	9.5	↗
6:	6.7	→
7:	10.2	→
8:	8.0	↓
9:	8.4	↓
10:	6.4	↘
Serie	74 (0x)	
Total	320 (0x)	

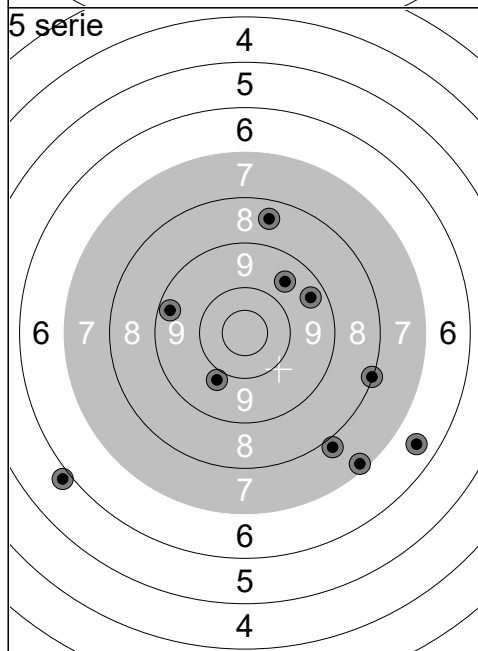

1:	8.1	→
2:	7.2	↘
3:	9.6	↗
4:	9.3	←
5:	9.9	↓
6:	5.9	←
7:	7.9	↘
8:	8.5	↗
9:	9.4	↗
10:	6.5	↘
Serie	77 (0x)	
Total	397 (0x)	

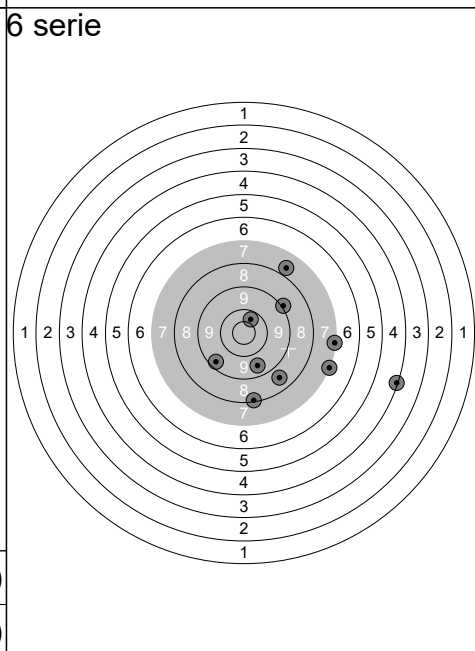

1:	9.3	↘
2:	9.5	↘
3:	9.0	↗
4:	7.1	→
5:	8.1	↓
6:	10.3	↗
7:	7.1	→
8:	8.6	↘
9:	4.1	→
10:	7.7	↗
Serie	78 (0x)	
Total	475 (0x)	

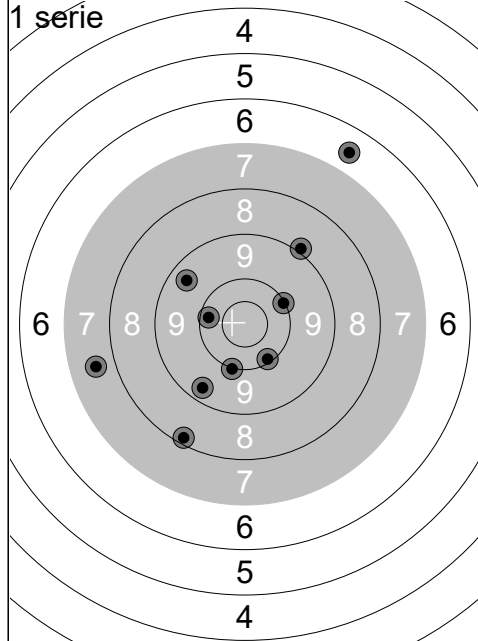

1:	10.1	↘
2:	10.2	←
3:	9.4	↘
4:	8.2	↘
5:	10.0	↘
6:	6.6	↗
7:	9.0	↗
8:	7.6	←
9:	10.1	↗
10:	9.5	↖
Serie	88 (0x)	
Total	88 (0x)	

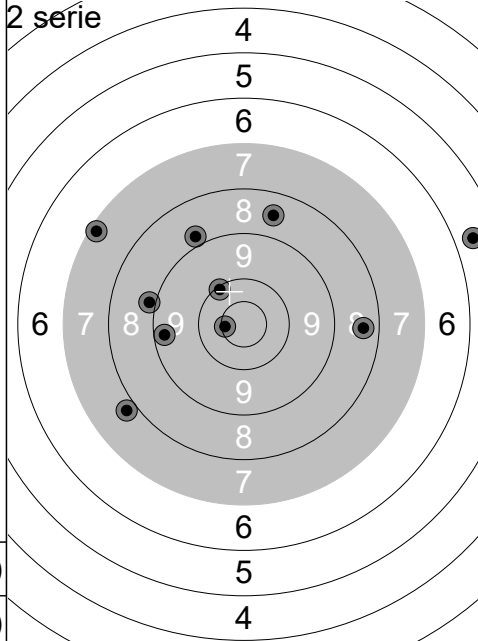

1:	10.1	↗
2:	5.6	→
3:	8.9	←
4:	8.6	↑
5:	8.4	→
6:	7.2	↖
7:	10.6x	←
8:	9.3	←
9:	7.8	↘
10:	8.8	↗
Serie	80 (1x)	
Total	168 (1x)	

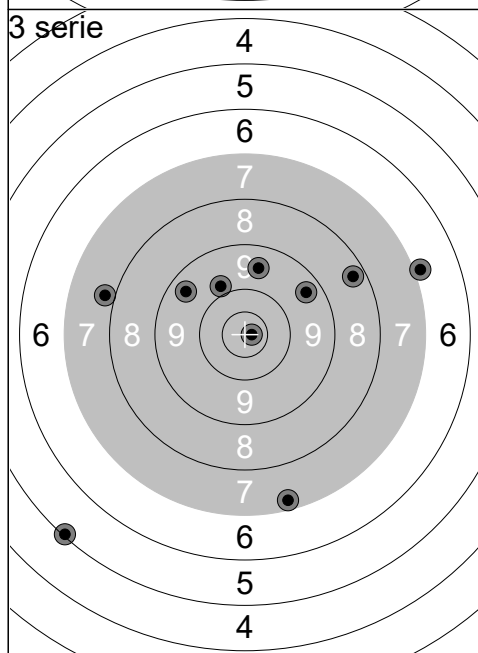

1:	9.4	↖
2:	9.4	↗
3:	9.5	↑
4:	10.8x	→
5:	8.3	↗
6:	7.3	↘
7:	6.9	↗
8:	5.1	↘
9:	9.9	↗
10:	7.8	←
Serie	79 (1x)	
Total	247 (2x)	

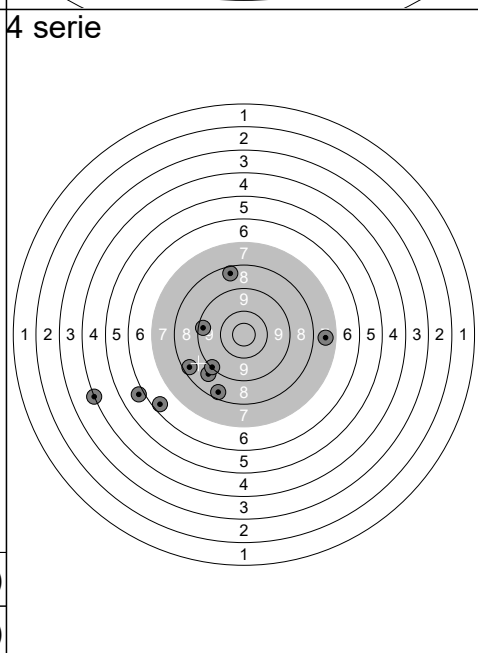

1:	8.3	←
2:	7.5	→
3:	8.3	↑
4:	9.3	←
5:	8.8	↘
6:	6.3	↘
7:	5.8	←
8:	9.1	↘
9:	8.3	↘
10:	4.1	←
Serie	72 (0x)	
Total	319 (2x)	

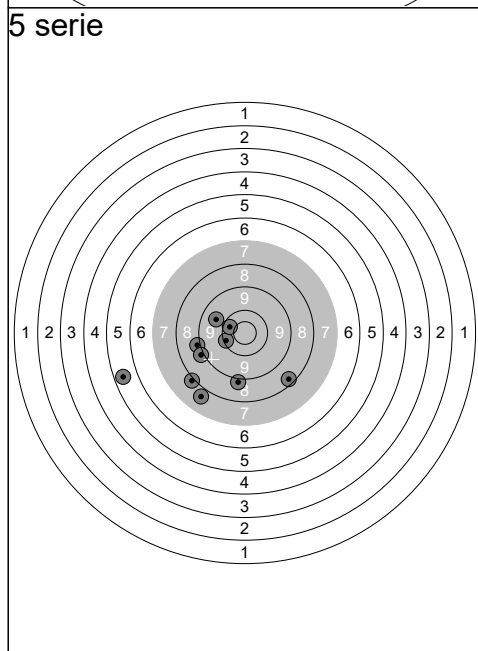

1:	8.9	←
2:	10.2	←
3:	9.7	↖
4:	8.3	↘
5:	8.9	↘
6:	8.0	↖
7:	7.7	↘
8:	8.9	←
9:	5.5	←
10:	10.3	←
Serie	81 (0x)	
Total	400 (2x)	

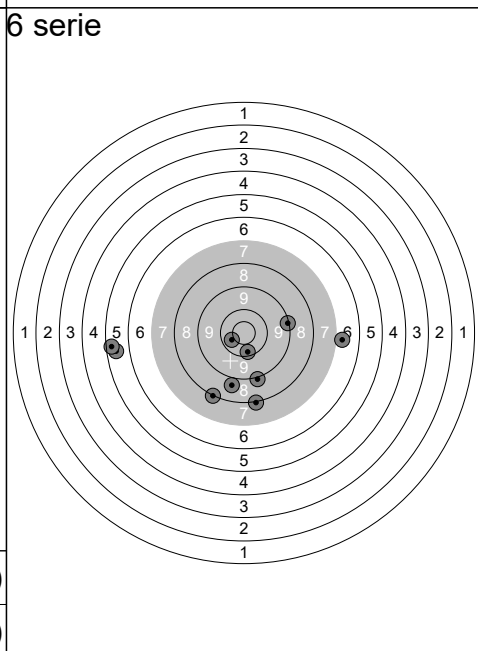

1:	8.0	↘
2:	10.4x	↖
3:	8.0	↘
4:	9.1	→
5:	9.0	↘
6:	6.8	→
7:	5.5	←
8:	8.7	↘
9:	10.2	↘
10:	5.3	←
Serie	78 (1x)	
Total	478 (3x)	

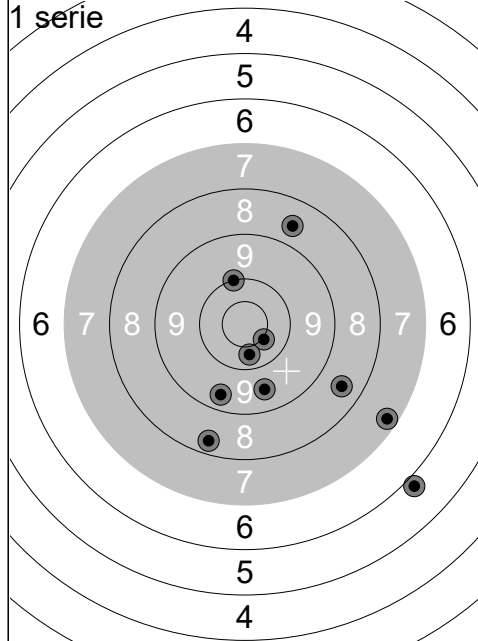

1:	9.6	↘
2:	5.9	↘
3:	8.4	↘
4:	9.4	↘
5:	8.5	↘
6:	8.6	↗
7:	10.5x	↘
8:	10.0	↗
9:	7.3	↘
10:	10.3	↘
Serie	84	(1x)
Total	84	(1x)

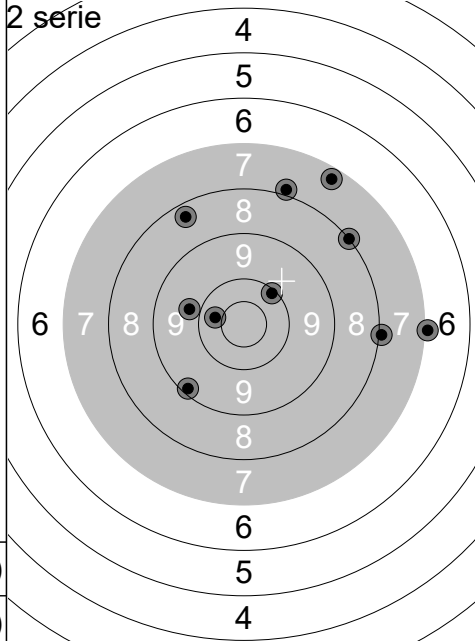

1:	8.4	↗
2:	9.8	↖
3:	8.1	↗
4:	7.9	↗
5:	10.4	↖
6:	8.0	→
7:	7.0	→
8:	10.1	↗
9:	9.2	↘
10:	7.3	↗
Serie	83	(0x)
Total	167	(1x)

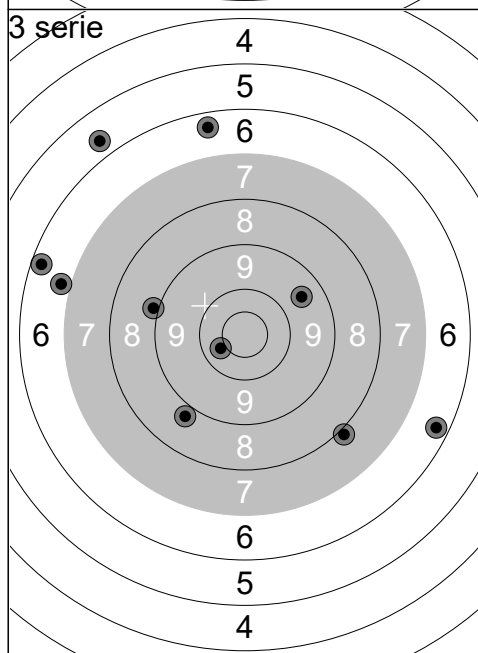

1:	9.5	↗
2:	7.9	↘
3:	10.4	↖
4:	8.8	↘
5:	6.3	↖
6:	5.7	↗
7:	6.8	↖
8:	8.9	↖
9:	6.4	↗
10:	6.3	↘
Serie	71	(0x)
Total	238	(1x)

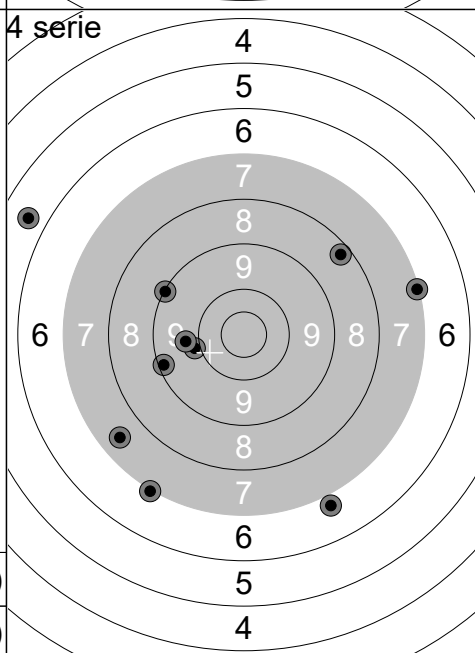

1:	9.9	↖
2:	8.3	↗
3:	6.8	↘
4:	9.1	↖
5:	9.2	↖
6:	9.8	↖
7:	7.0	↘
8:	5.6	↖
9:	7.5	↘
10:	7.1	→
Serie	76	(0x)
Total	314	(1x)

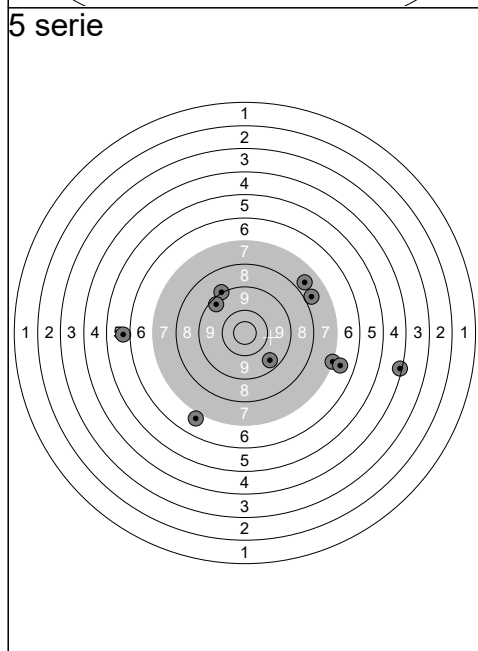

1:	7.7	↗
2:	7.8	↗
3:	5.8	↖
4:	9.0	↗
5:	9.3	↗
6:	4.2	→
7:	9.5	↘
8:	7.1	→
9:	6.8	↘
10:	6.7	→
Serie	69	(0x)
Total	383	(1x)

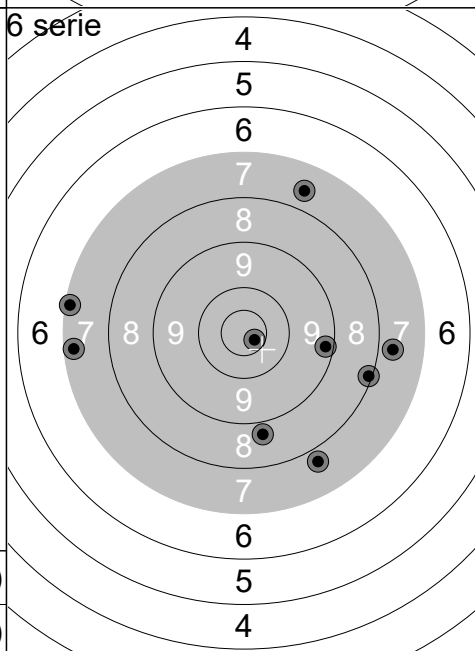

1:	10.7x	↘
2:	7.8	→
3:	8.8	↘
4:	8.1	→
5:	7.6	↗
6:	7.8	↘
7:	0.0	
8:	7.2	↖
9:	9.2	→
10:	7.3	↖
Serie	70	(1x)
Total	453	(2x)

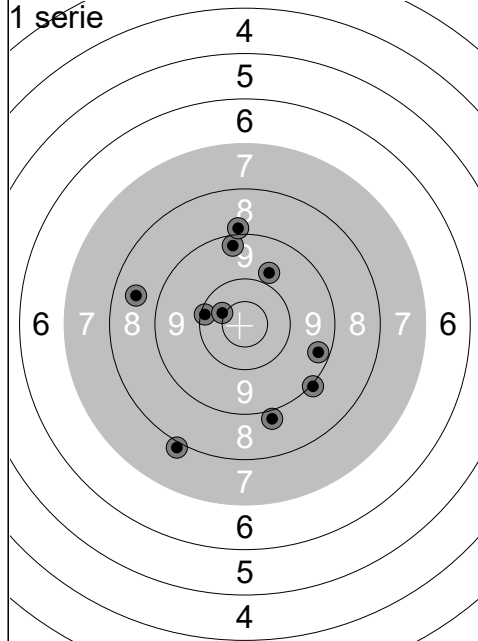

1:	9.8	↗
2:	10.1	↖
3:	9.3	↗
4:	8.6	↖
5:	8.9	↗
6:	8.9	↘
7:	7.9	↘
8:	9.3	↘
9:	9.0	↘
10:	10.4x	↖
Serie		87 (1x)
Total		87 (1x)

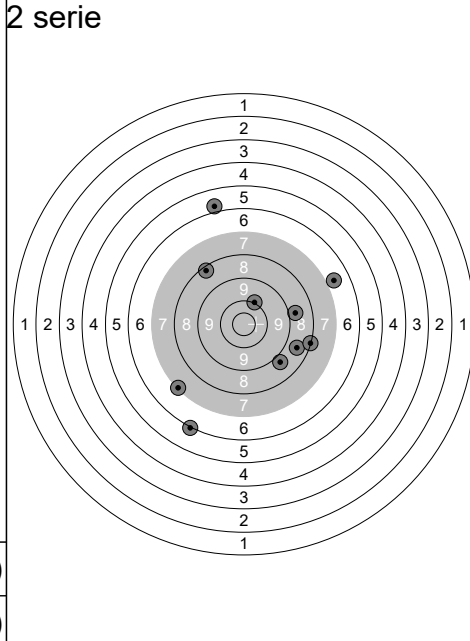

1:	8.6	↘
2:	8.8	↘
3:	7.1	↖
4:	8.8	↗
5:	6.0	↘
6:	6.7	↗
7:	8.2	↗
8:	10.0	↗
9:	8.1	↗
10:	5.8	↗
Serie		74 (0x)
Total		161 (1x)

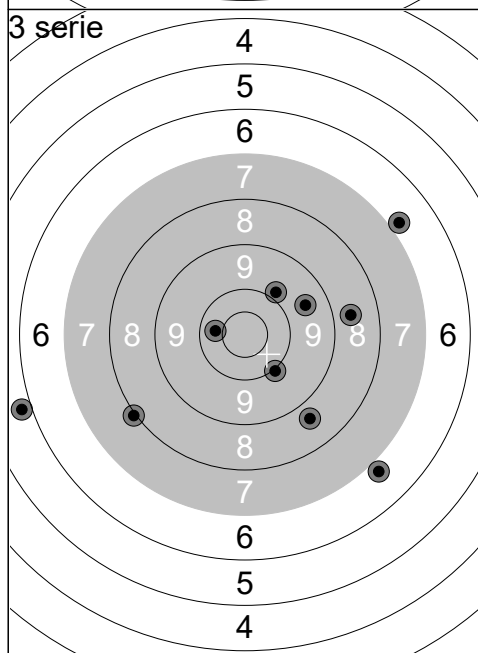

1:	8.7	↘
2:	8.0	↖
3:	6.8	↘
4:	10.0	↘
5:	9.6	↗
6:	6.8	↗
7:	5.9	↖
8:	10.4	↖
9:	8.7	↗
10:	9.9	↗
Serie		79 (0x)
Total		240 (1x)

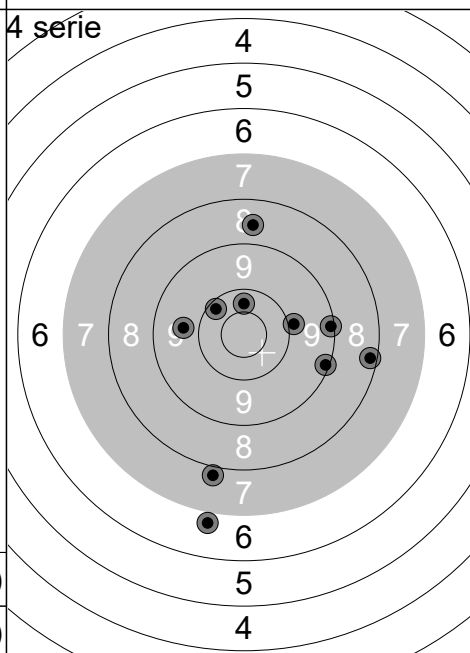

1:	8.2	↗
2:	7.9	↘
3:	9.7	↖
4:	10.3	↗
5:	8.6	↗
6:	9.1	↗
7:	9.1	↗
8:	6.8	↘
9:	10.2	↖
10:	9.9	↗
Serie		85 (0x)
Total		325 (1x)

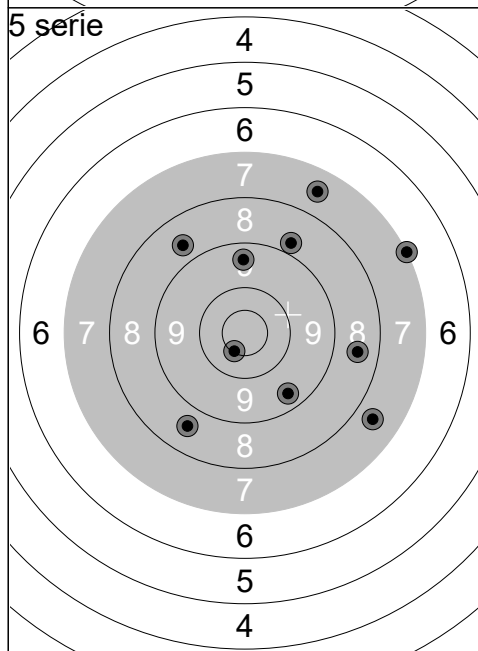

1:	7.6	↘
2:	8.5	↗
3:	8.7	↗
4:	8.8	↗
5:	7.5	↗
6:	9.4	↗
7:	10.5x	↘
8:	8.6	↘
9:	7.0	↗
10:	9.4	↘
Serie		81 (1x)
Total		406 (2x)

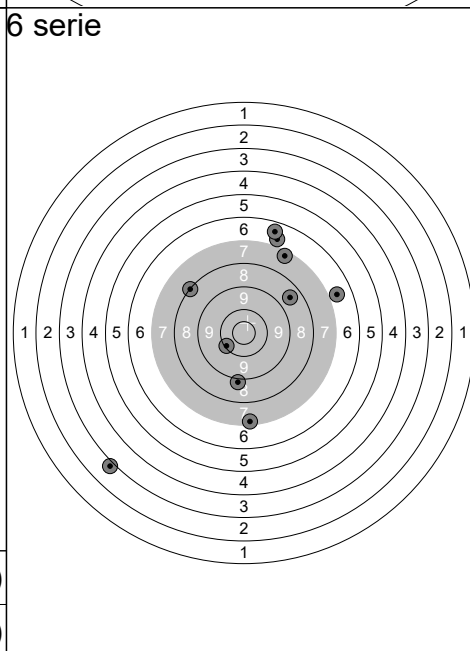

1:	6.7	↗
2:	8.0	↖
3:	2.9	↘
4:	6.7	↗
5:	10.1	↖
6:	6.5	↗
7:	8.9	↘
8:	8.6	↗
9:	7.3	↗
10:	7.2	↘
Serie		68 (0x)
Total		474 (2x)

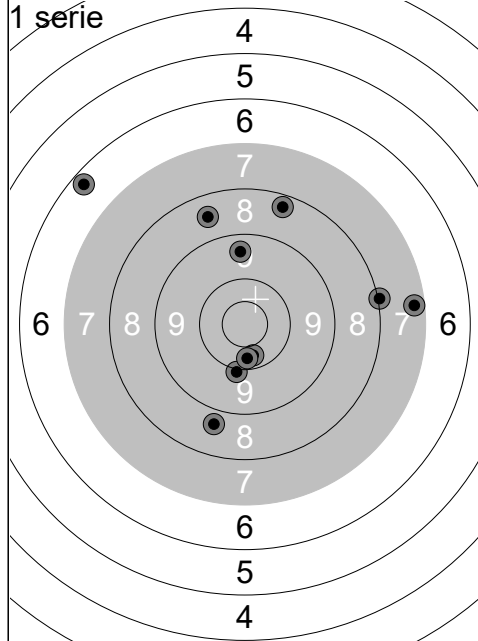

1:	10.0	↓
2:	9.4	↑
3:	8.3	↑
4:	8.0	→
5:	6.3	↖
6:	8.5	↑
7:	10.3	↓
8:	10.3	↓
9:	7.3	→
10:	8.7	↓
Serie	84 (0x)	
Total	84 (0x)	

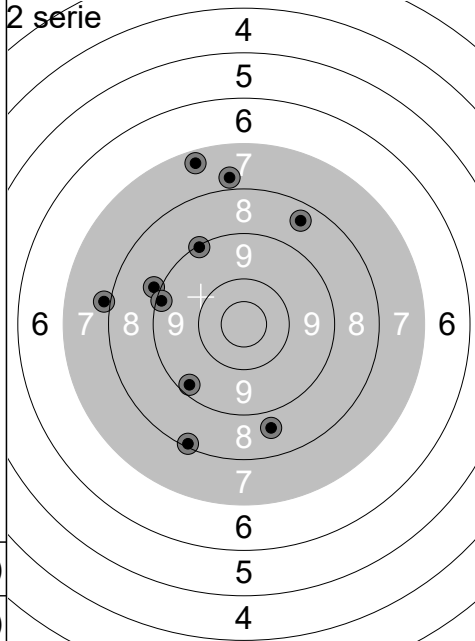

1:	9.3	↙
2:	9.1	↗
3:	8.7	↓
4:	8.4	↗
5:	7.9	←
6:	7.3	↑
7:	7.8	↑
8:	8.1	↓
9:	8.9	←
10:	9.2	←
Serie	80 (0x)	
Total	164 (0x)	

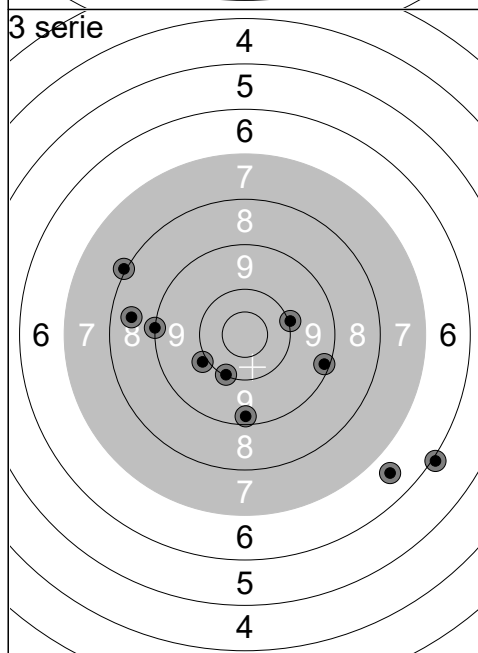

1:	8.0	↖
2:	10.1	↓
3:	10.0	→
4:	9.2	→
5:	9.3	↓
6:	8.5	←
7:	9.1	←
8:	6.6	↘
9:	9.9	←
10:	6.0	↘
Serie	84 (0x)	
Total	248 (0x)	

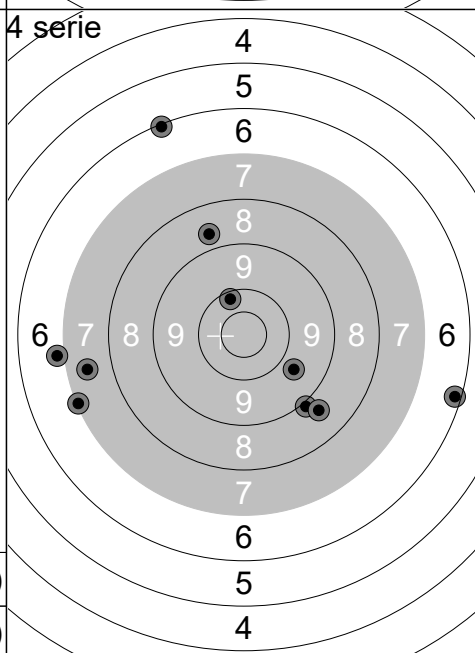

1:	6.1	↑
2:	6.2	→
3:	9.7	↘
4:	7.5	←
5:	10.2	↑
6:	7.1	←
7:	6.9	←
8:	9.0	↘
9:	8.7	↑
10:	8.7	↘
Serie	76 (0x)	
Total	324 (0x)	

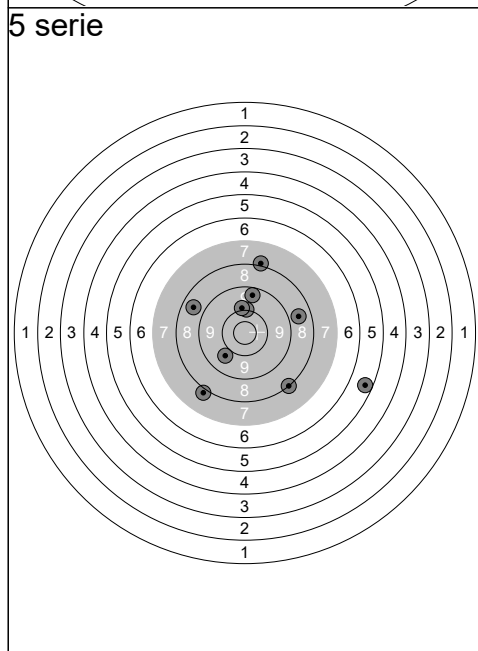

1:	10.0	↑
2:	9.8	↘
3:	7.9	↘
4:	8.6	↖
5:	10.0	↑
6:	8.1	↘
7:	5.4	→
8:	8.0	↑
9:	8.6	→
10:	9.4	↑
Serie	82 (0x)	
Total	406 (0x)	

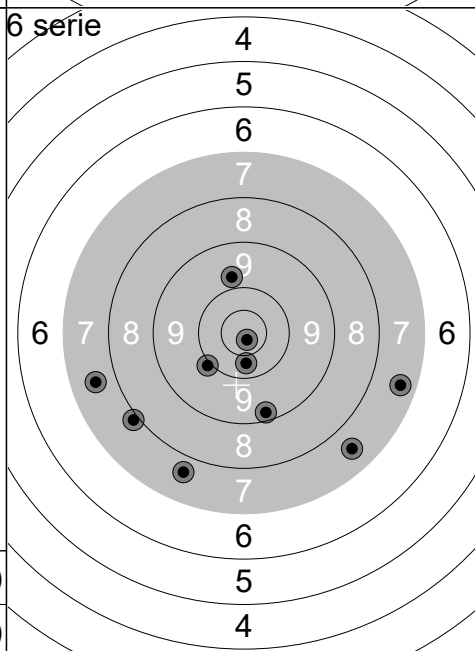

1:	7.4	→
2:	9.2	↓
3:	10.0	↘
4:	8.0	↖
5:	7.6	↘
6:	10.3	↓
7:	7.6	←
8:	9.8	↑
9:	7.7	↘
10:	10.8x	↘
Serie	84 (1x)	
Total	490 (1x)	

1 serie

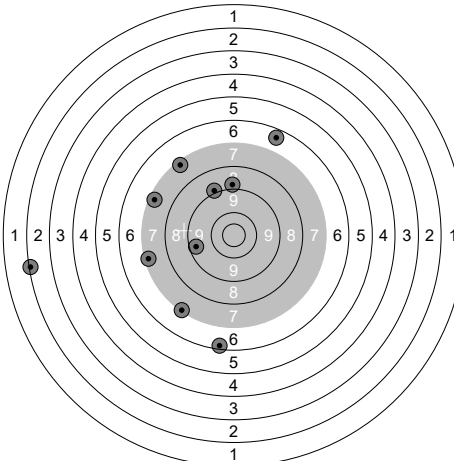

1:	2.1	←
2:	7.2	↖
3:	7.1	↘
4:	9.3	←
5:	7.3	←
6:	6.4	↗
7:	8.9	↗
8:	8.9	↑
9:	7.2	←
10:	6.2	↓
Serie	67 (0x)	
Total	67 (0x)	

2 serie

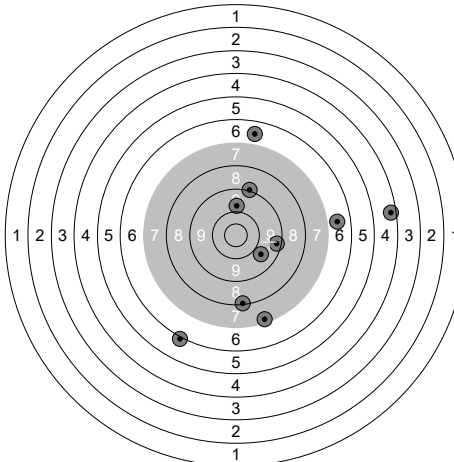

1:	7.2	↓
2:	9.8	↑
3:	6.6	→
4:	9.7	↘
5:	6.0	↘
6:	8.1	↓
7:	6.6	↑
8:	9.0	↑
9:	9.3	→
10:	4.3	→
Serie	73 (0x)	
Total	140 (0x)	

3 serie

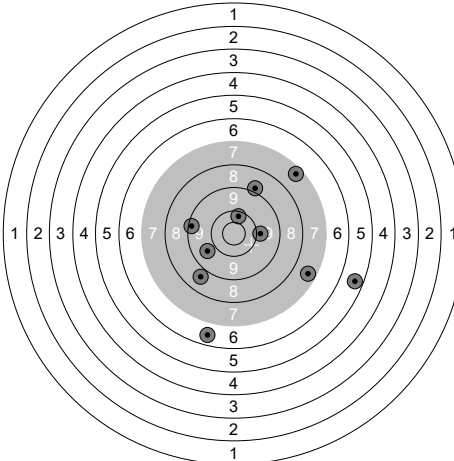

1:	9.2	←
2:	8.9	↗
3:	9.7	←
4:	6.5	↓
5:	7.4	→
6:	8.7	↘
7:	10.2	↑
8:	5.4	→
9:	7.3	↗
10:	9.9	→
Serie	78 (0x)	
Total	218 (0x)	

4 serie

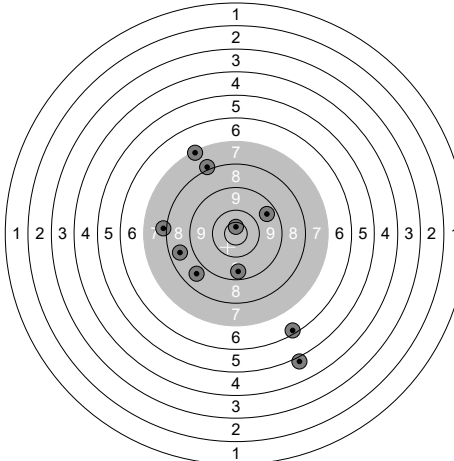

1:	9.4	↓
2:	7.1	↖
3:	7.9	←
4:	10.7x	↑
5:	4.9	↓
6:	8.5	←
7:	9.5	↗
8:	8.6	↘
9:	6.2	↓
10:	7.9	↖
Serie	75 (1x)	
Total	293 (1x)	

5 serie

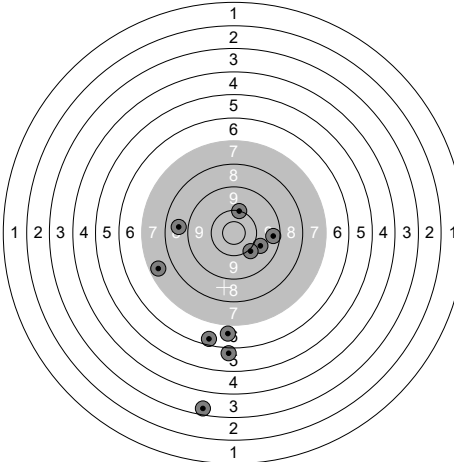

1:	6.3	↓
2:	3.3	↓
3:	5.8	↓
4:	8.7	←
5:	9.8	→
6:	7.4	←
7:	10.1	↑
8:	9.3	→
9:	6.7	↓
10:	10.0	↘
Serie	73 (0x)	
Total	366 (1x)	

6 serie

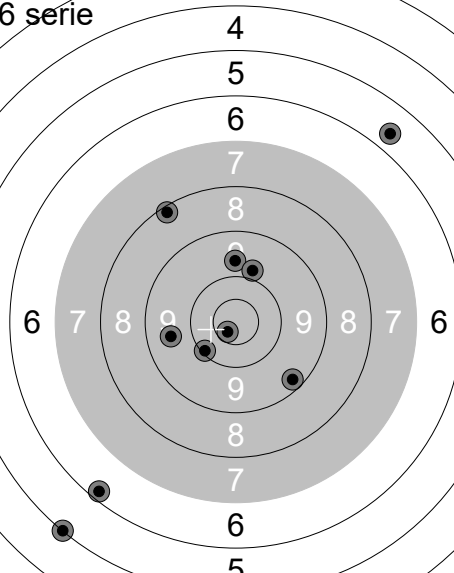

1:	5.7	↗
2:	5.1	↘
3:	10.7x	↘
4:	6.2	↘
5:	9.6	←
6:	9.7	↑
7:	8.2	↖
8:	9.9	↑
9:	9.3	↘
10:	10.1	↘
Serie	80 (1x)	
Total	446 (2x)	

6 serie

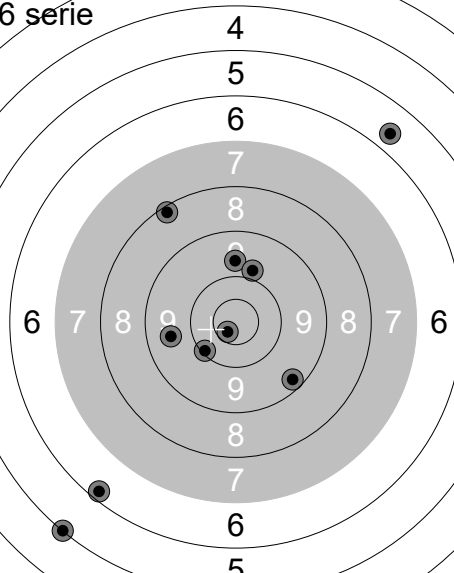

1:	5.7	↗
2:	5.1	↘
3:	10.7x	↘
4:	6.2	↘
5:	9.6	←
6:	9.7	↑
7:	8.2	↖
8:	9.9	↑
9:	9.3	↘
10:	10.1	↘
Serie	80 (1x)	
Total	446 (2x)	

1 serie

1:	5.3	➔
2:	0.0	↗
3:	4.9	➤
4:	5.6	↙
5:	6.1	↗
6:	5.1	➔
7:	4.1	➔
8:	7.5	↙
9:	5.3	↘
10:	9.7	↙
Serie		50 (0x)
Total		50 (0x)

2 serie

1:	7.1	➔
2:	6.0	↙
3:	5.9	↘
4:	9.0	↙
5:	8.9	↘
6:	0.0	↗
7:	2.9	↗
8:	2.5	↘
9:	6.7	➔
10:	5.7	↑
Serie		50 (0x)
Total		100 (0x)

3 serie

1:	8.6	↑
2:	8.2	↗
3:	5.6	↘
4:	5.9	↘
5:	8.3	➔
6:	1.1	↘
7:	0.0	➔
8:	8.4	↑
9:	1.5	➔
10:	5.0	↗
Serie		49 (0x)
Total		149 (0x)

4 serie

1:	6.9	↘
2:	4.0	↙
3:	2.8	↘
4:	3.8	➤
5:	2.9	↗
6:	6.7	↗
7:	5.3	➔
8:	6.8	↑
9:	7.8	↗
10:	3.9	↘
Serie		44 (0x)
Total		193 (0x)

5 serie

1:	7.8	↙
2:	6.1	➔
3:	4.2	↘
4:	6.8	➔
5:	8.0	↘
6:	0.0	↑
7:	8.2	↘
8:	3.0	↘
9:	1.8	↙
10:	0.0	
Serie		43 (0x)
Total		236 (0x)

6 serie

1:	0.0	
2:	0.0	
3:	0.0	
4:	0.0	
5:	0.0	
6:	0.0	
7:	0.0	
8:	0.0	
9:	0.0	
10:	0.0	➔
Serie		0 (0x)
Total		236 (0x)

5 serie

1:	7.8	↙
2:	6.1	➔
3:	4.2	↘
4:	6.8	➔
5:	8.0	↘
6:	0.0	↑
7:	8.2	↘
8:	3.0	↘
9:	1.8	↙
10:	0.0	
Serie		43 (0x)
Total		236 (0x)

6 serie

1:	0.0	
2:	0.0	
3:	0.0	
4:	0.0	
5:	0.0	
6:	0.0	
7:	0.0	
8:	0.0	
9:	0.0	
10:	0.0	➔
Serie		0 (0x)
Total		236 (0x)

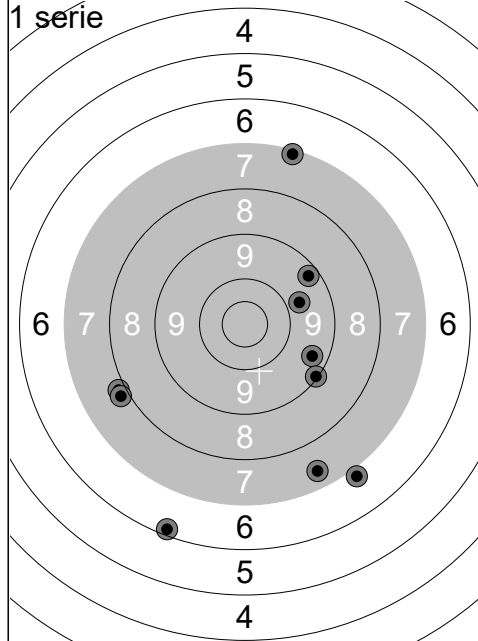

1:	7.9	↙
2:	6.9	↘
3:	9.4	➡
4:	7.9	↙
5:	7.1	↑
6:	9.1	↘
7:	6.2	↘
8:	9.3	➡
9:	7.4	↘
10:	9.8	➡
Serie		76 (0x)
Total		76 (0x)

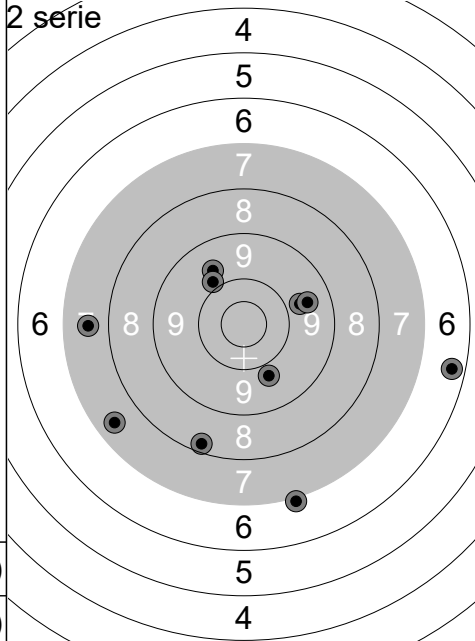

1:	9.7	↗
2:	8.3	↘
3:	7.0	↘
4:	7.5	↙
5:	9.7	➡
6:	9.9	↗
7:	7.6	↙
8:	9.6	➡
9:	6.4	➡
10:	9.8	↘
Serie		80 (0x)
Total		156 (0x)

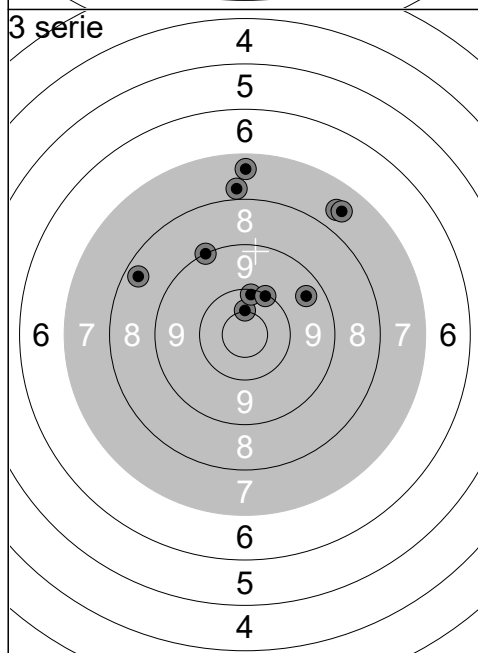

1:	10.5x	↑
2:	8.4	↙
3:	10.1	↑
4:	7.8	↑
5:	9.5	➡
6:	10.1	↗
7:	7.6	↗
8:	9.1	↗
9:	7.4	↑
10:	7.6	↗
Serie		84 (1x)
Total		240 (1x)

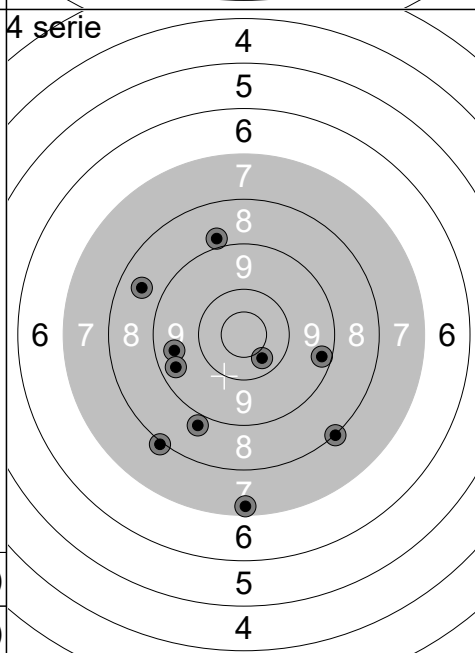

1:	8.0	↘
2:	9.5	↙
3:	8.8	↑
4:	8.6	↙
5:	8.0	↘
6:	8.8	↘
7:	7.3	↘
8:	9.3	➡
9:	9.4	↙
10:	10.4	↘
Serie		84 (0x)
Total		324 (1x)

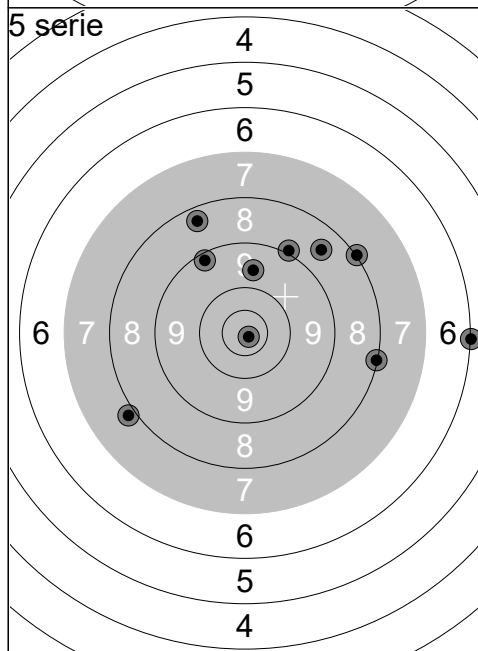

1:	10.8x	↘
2:	9.0	↗
3:	8.4	↗
4:	9.7	↑
5:	7.9	↙
6:	8.0	➡
7:	6.1	➡
8:	8.1	➡
9:	8.6	↗
10:	9.2	↙
Serie		82 (1x)
Total		406 (2x)

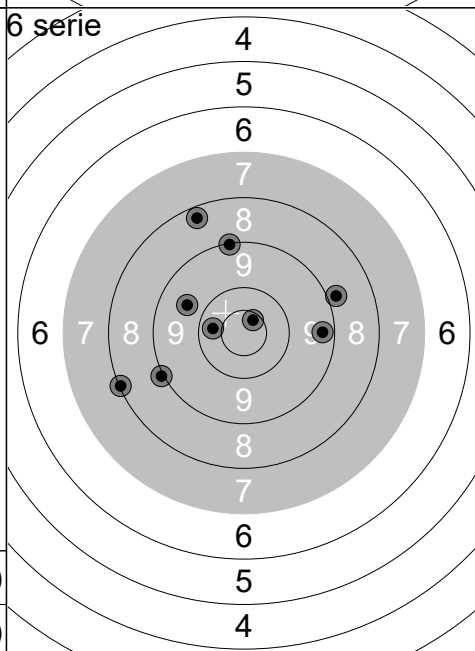

1:	9.1	↑
2:	9.7	↙
3:	10.3	↙
4:	8.3	↗
5:	9.0	↙
6:	8.1	↙
7:	8.9	➡
8:	9.3	➡
9:	10.6x	↗
10:	0.0	
Serie		80 (1x)
Total		486 (3x)

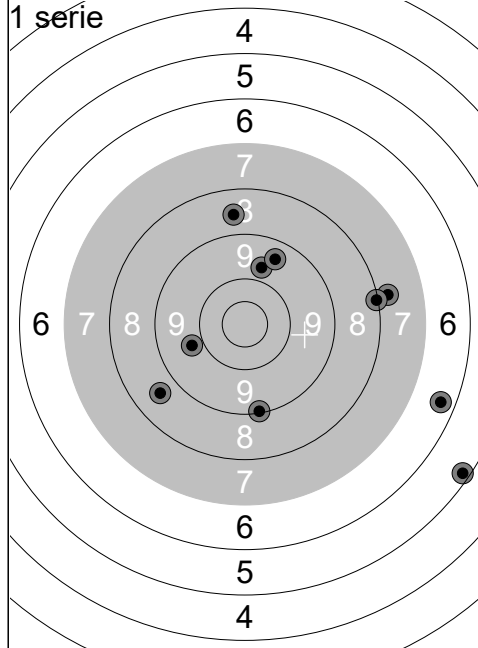

1:	9.8	↔
2:	9.7	↗
3:	5.2	↘
4:	8.6	↗
5:	9.1	↘
6:	8.6	↖
7:	6.4	↘
8:	9.5	↗
9:	7.8	↘
10:	8.1	↘
Serie	78 (0x)	
Total	78 (0x)	

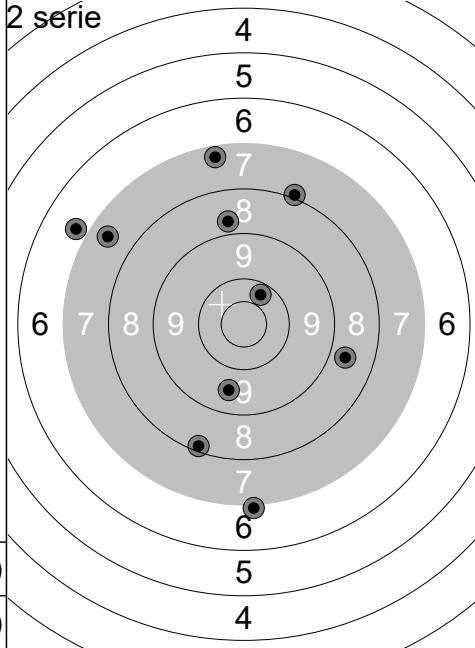

1:	7.3	↗
2:	8.0	↗
3:	8.8	↗
4:	8.2	↘
5:	7.5	↖
6:	9.6	↘
7:	7.0	↘
8:	6.8	↖
9:	10.3	↗
10:	8.7	↘
Serie	78 (0x)	
Total	156 (0x)	

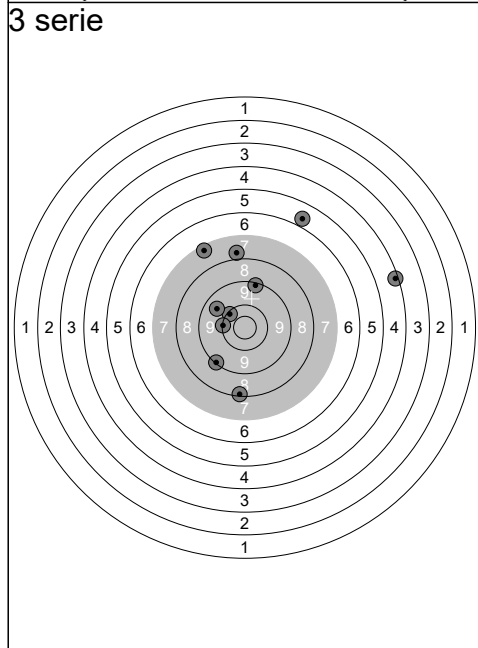

1:	10.2	↖
2:	9.6	↖
3:	9.1	↘
4:	10.1	↔
5:	7.8	↗
6:	8.2	↘
7:	5.7	↗
8:	9.2	↗
9:	7.3	↖
10:	4.2	↘
Serie	78 (0x)	
Total	234 (0x)	

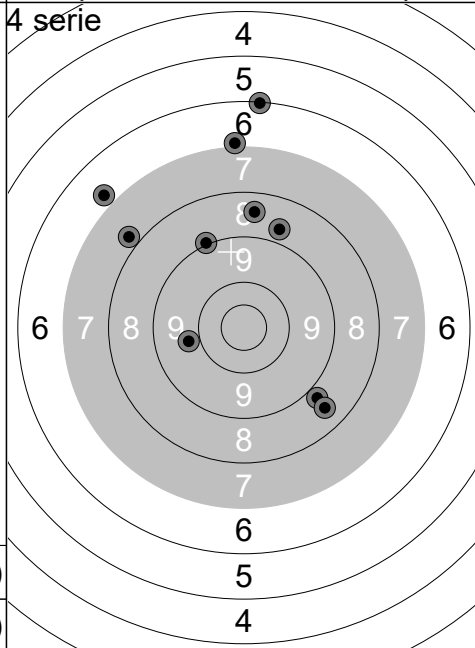

1:	8.5	↗
2:	8.7	↗
3:	6.1	↗
4:	6.8	↖
5:	9.8	↖
6:	7.0	↗
7:	8.8	↘
8:	9.0	↗
9:	7.8	↖
10:	8.5	↘
Serie	76 (0x)	
Total	310 (0x)	

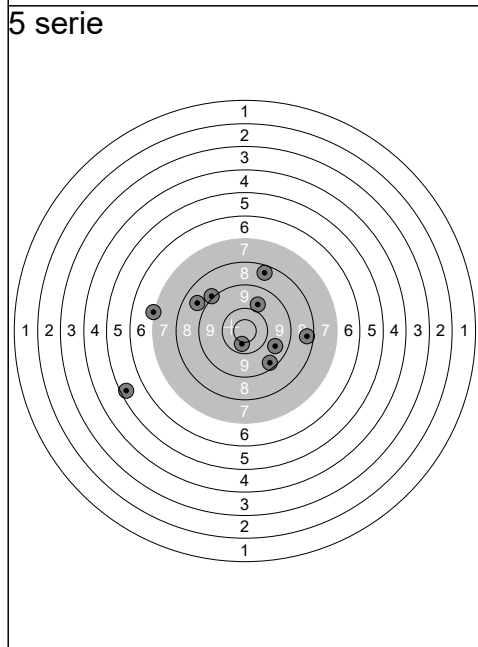

1:	10.4x	↘
2:	8.7	↖
3:	7.0	↖
4:	9.3	↘
5:	9.8	↗
6:	8.4	↘
7:	9.6	↘
8:	8.4	↗
9:	9.0	↖
10:	5.3	↖
Serie	82 (1x)	
Total	392 (1x)	

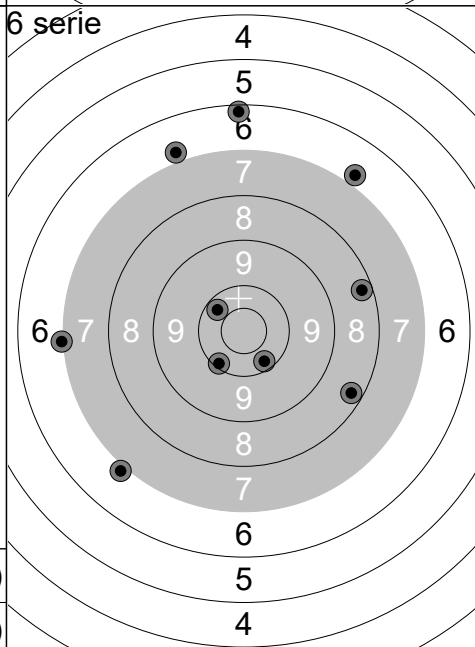

1:	8.3	↘
2:	6.9	↘
3:	6.2	↗
4:	6.8	↗
5:	10.3	↖
6:	6.8	↗
7:	7.0	↖
8:	10.1	↘
9:	8.3	↘
10:	10.2	↘
Serie	77 (0x)	
Total	469 (1x)	

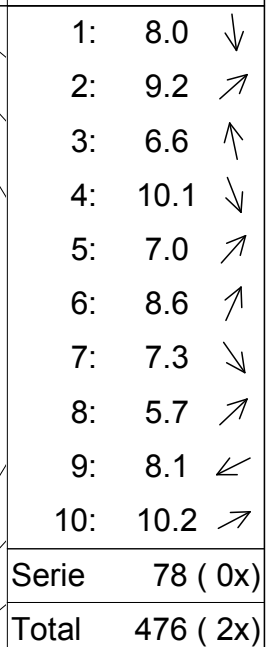
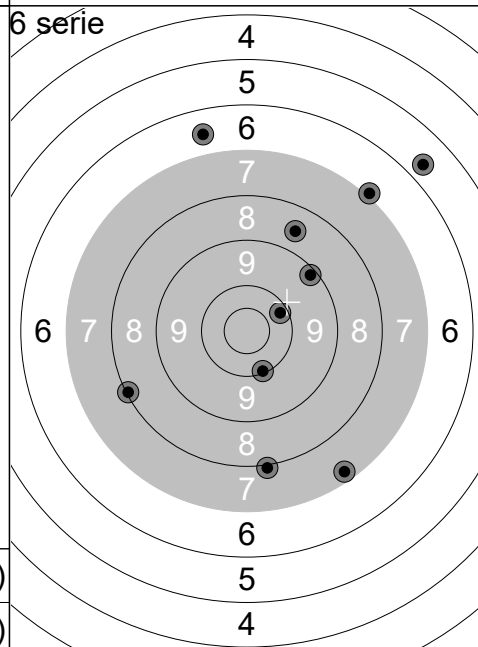
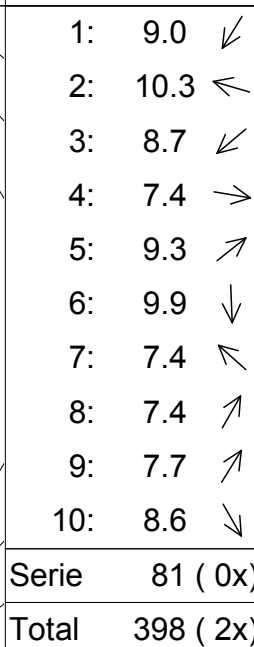
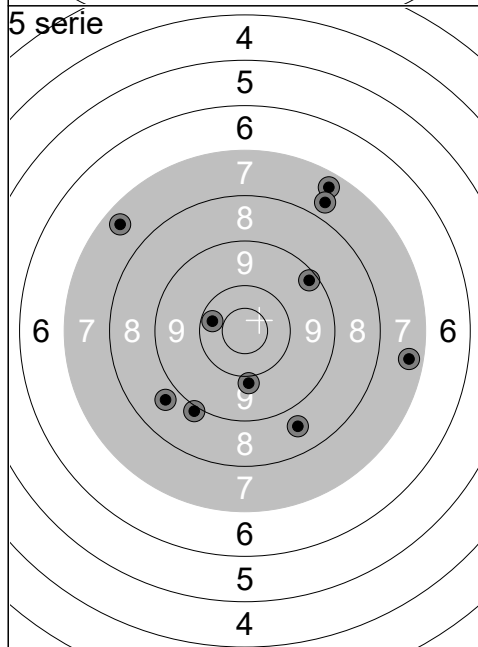
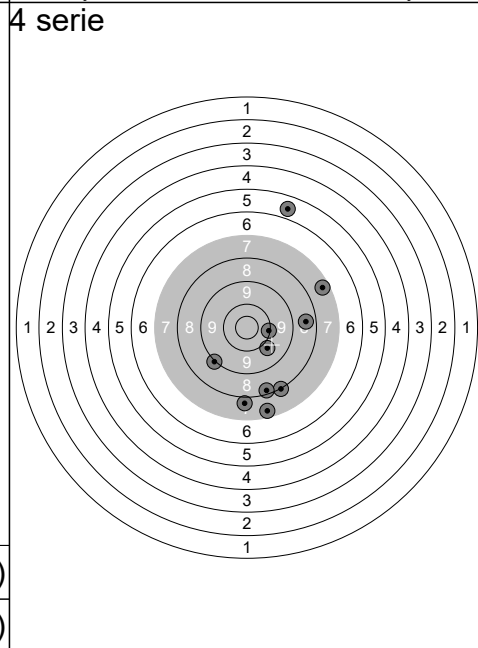
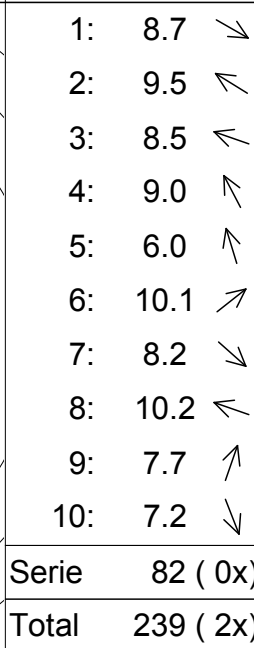
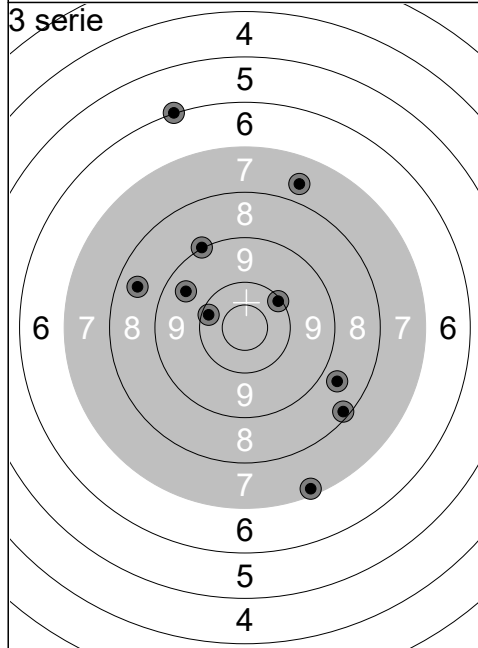
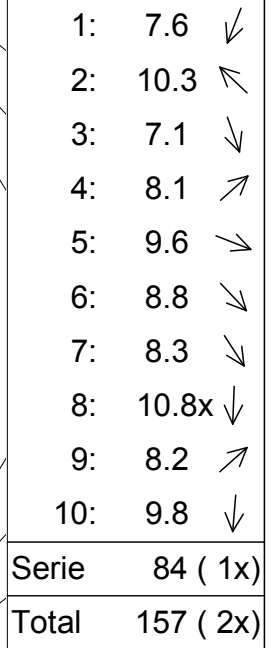
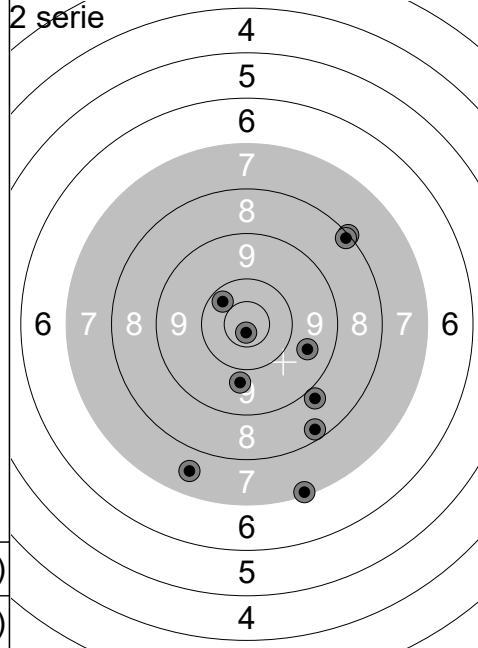
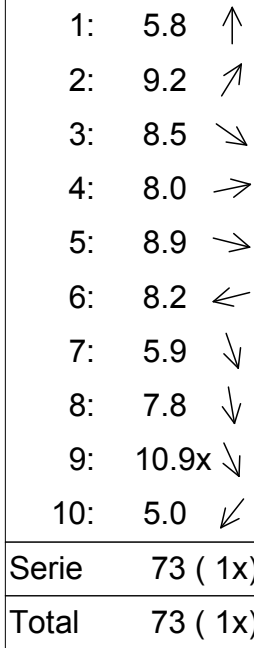
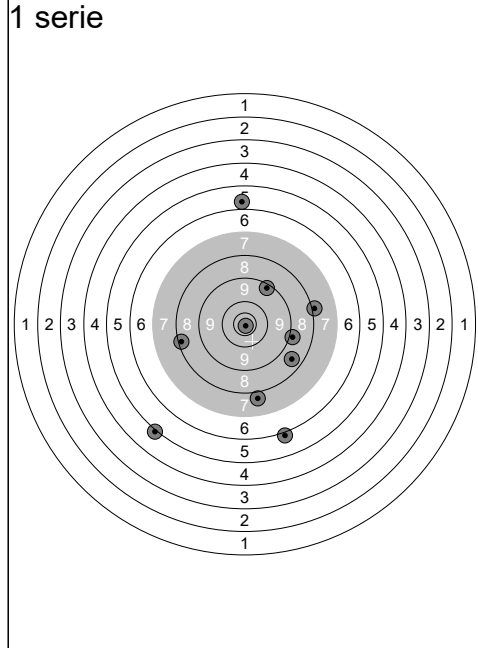

1 serie

1:	8.7	➔
2:	7.2	↘
3:	4.5	↘
4:	7.1	↘
5:	5.2	➔
6:	6.6	↘
7:	8.7	↘
8:	4.5	↘
9:	5.4	➔
10:	9.3	↘
Serie	63 (0x)	
Total	63 (0x)	

2 serie

1:	9.0	↔
2:	5.5	↘
3:	9.6	↑
4:	8.8	➔
5:	4.9	➔
6:	8.8	↘
7:	6.1	➔
8:	7.7	➔
9:	7.8	↘
10:	8.9	➔
Serie	71 (0x)	
Total	134 (0x)	

3 serie

1:	9.6	➔
2:	10.0	↘
3:	8.2	↘
4:	5.6	↘
5:	6.1	↘
6:	9.4	↘
7:	8.1	↑
8:	4.6	↔
9:	8.5	↔
10:	7.5	↘
Serie	74 (0x)	
Total	208 (0x)	

4 serie

1:	9.2	↑
2:	7.6	↘
3:	3.9	➔
4:	7.7	↔
5:	8.9	↘
6:	9.5	➔
7:	8.6	↘
8:	7.1	↘
9:	6.3	↘
10:	9.1	↘
Serie	73 (0x)	
Total	281 (0x)	

5 serie

1:	10.2	➔
2:	8.2	↘
3:	10.1	↔
4:	8.2	➔
5:	8.3	➔
6:	8.4	➔
7:	10.4	↘
8:	8.0	↘
9:	6.3	↘
10:	9.7	➔
Serie	85 (0x)	
Total	366 (0x)	

6 serie

1:	9.0	↘
2:	4.4	↘
3:	10.1	↘
4:	6.7	↘
5:	7.2	↔
6:	7.8	↑
7:	7.4	➔
8:	6.7	↘
9:	6.4	↘
10:	9.6	➔
Serie	71 (0x)	
Total	437 (0x)	

5 serie

1:	9.0	↘
2:	4.4	↘
3:	10.1	↘
4:	6.7	↘
5:	7.2	↔
6:	7.8	↑
7:	7.4	➔
8:	6.7	↘
9:	6.4	↘
10:	9.6	➔
Serie	71 (0x)	
Total	437 (0x)	

6 serie

1:	9.0	↘
2:	4.4	↘
3:	10.1	↘
4:	6.7	↘
5:	7.2	↔
6:	7.8	↑
7:	7.4	➔
8:	6.7	↘
9:	6.4	↘
10:	9.6	➔
Serie	71 (0x)	
Total	437 (0x)	

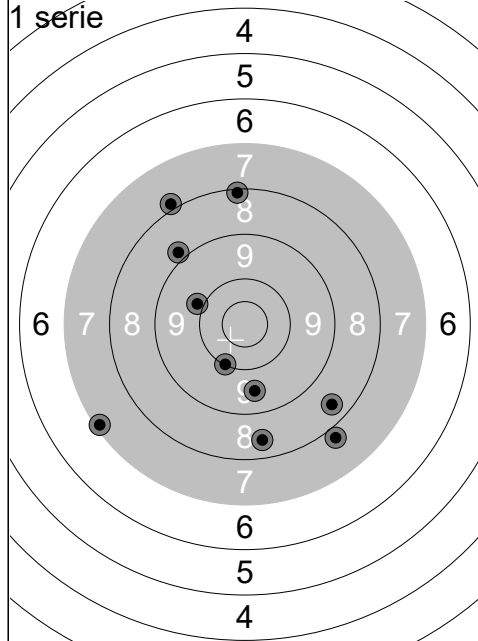

1:	9.6	↓
2:	7.8	↓
3:	8.4	↓
4:	10.1	↓
5:	7.9	↗
6:	8.1	↑
7:	9.9	←
8:	8.9	↗
9:	8.5	↓
10:	7.1	↙
Serie	81 (0x)	
Total	81 (0x)	

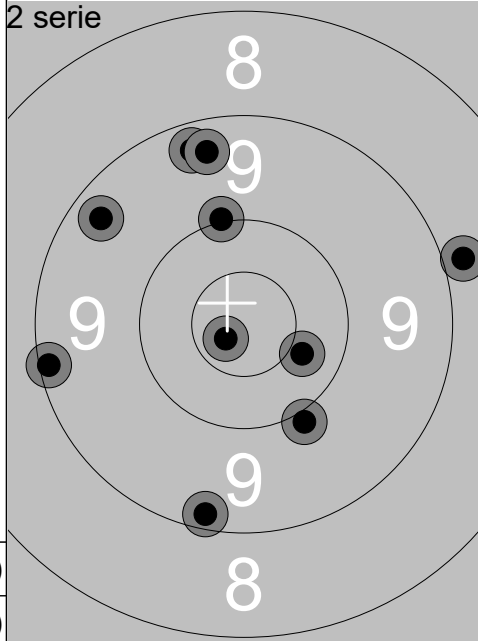

1:	9.2	↓
2:	9.4	↖
3:	9.3	↑
4:	10.0	↑
5:	10.4	⇒
6:	10.7x	↙
7:	8.9	⇒
8:	9.4	↑
9:	9.2	←
10:	10.0	↓
Serie	93 (1x)	
Total	174 (1x)	

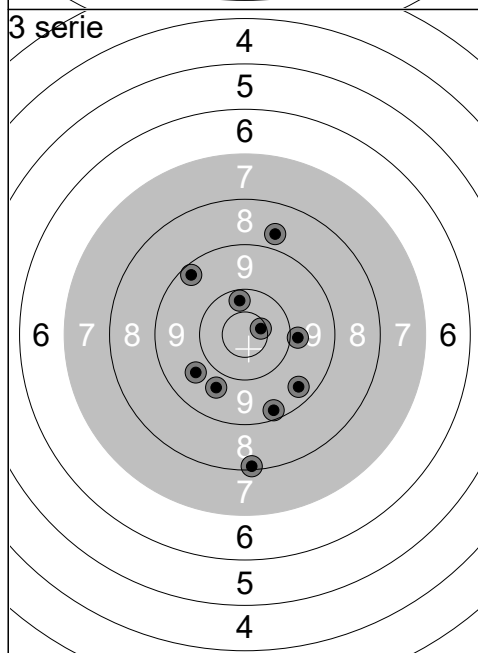

1:	9.4	↘
2:	10.3	↑
3:	8.7	↑
4:	9.3	↓
5:	9.7	↓
6:	9.7	←
7:	10.6x	⇒
8:	9.3	↗
9:	8.1	↓
10:	9.9	⇒
Serie	90 (1x)	
Total	264 (2x)	

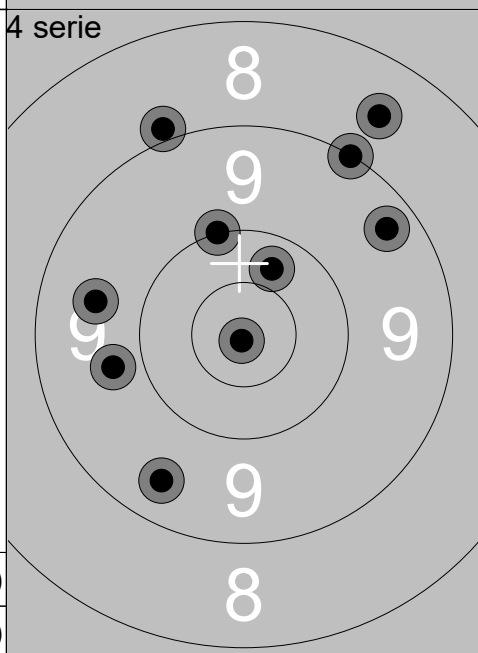

1:	10.3	↑
2:	9.8	←
3:	9.5	↓
4:	9.6	←
5:	9.1	↗
6:	8.6	↗
7:	10.9x	↓
8:	10.0	↑
9:	8.9	↑
10:	9.4	↗
Serie	91 (1x)	
Total	355 (3x)	

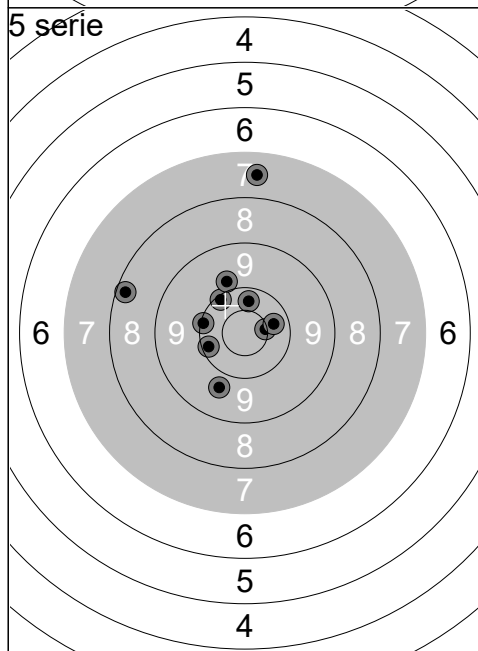

1:	10.2	←
2:	10.1	←
3:	10.1	↗
4:	10.3	↑
5:	7.5	↑
6:	9.9	↑
7:	9.7	↓
8:	8.3	←
9:	10.5x	⇒
10:	10.3	⇒
Serie	93 (1x)	
Total	448 (4x)	

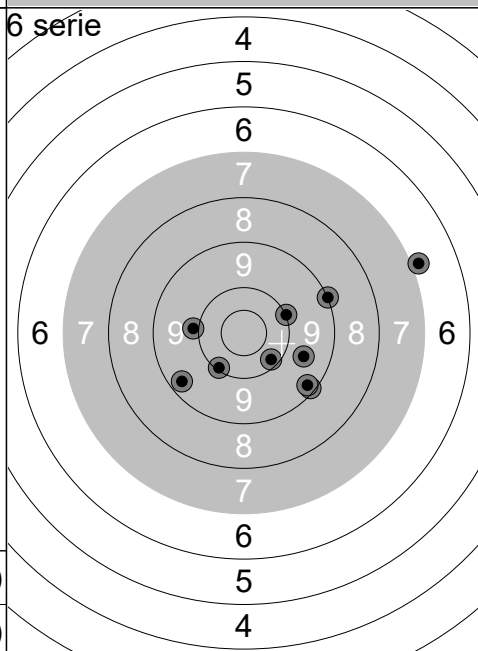

1:	9.9	←
2:	9.0	⇒
3:	9.1	↓
4:	10.1	↓
5:	6.9	⇒
6:	10.2	↓
7:	9.2	↓
8:	9.3	←
9:	9.6	⇒
10:	10.0	⇒
Serie	90 (0x)	
Total	538 (4x)	

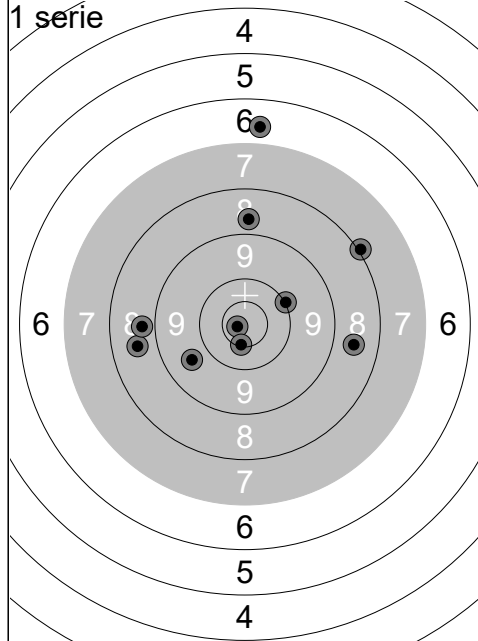

1:	10.0	↗
2:	9.7	↙
3:	6.7	↑
4:	10.8x	↙
5:	8.7	↑
6:	8.6	←
7:	10.5x	↓
8:	8.8	←
9:	8.6	→
10:	8.0	↗
Serie	85	(2x)
Total	85	(2x)

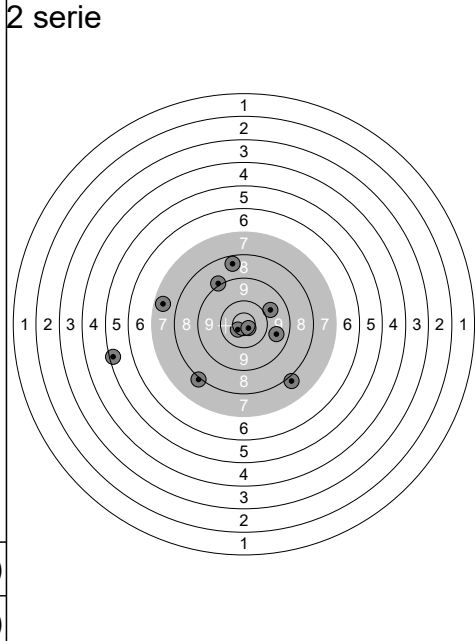

1:	5.2	↙
2:	10.6x	↙
3:	9.6	→
4:	10.7x	↘
5:	7.8	↘
6:	7.4	←
7:	8.0	↙
8:	9.0	↗
9:	9.8	↗
10:	8.4	↑
Serie	82	(2x)
Total	167	(4x)

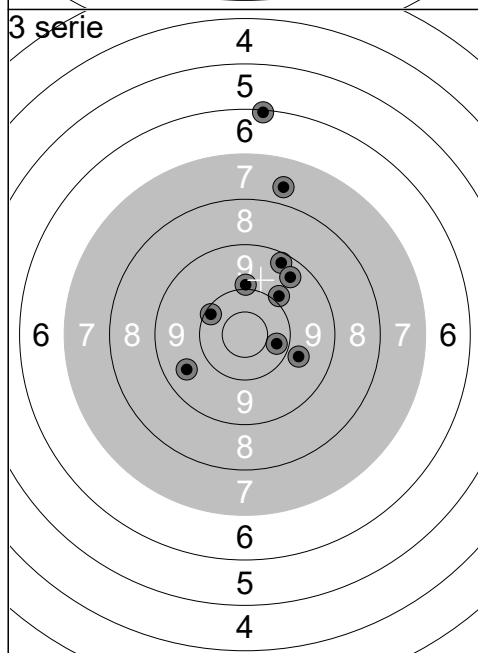

1:	10.3	→
2:	9.6	↙
3:	9.3	↗
4:	10.0	↑
5:	9.9	↗
6:	9.4	↗
7:	6.1	↑
8:	10.2	↙
9:	7.7	↑
10:	9.8	→
Serie	88	(0x)
Total	255	(4x)

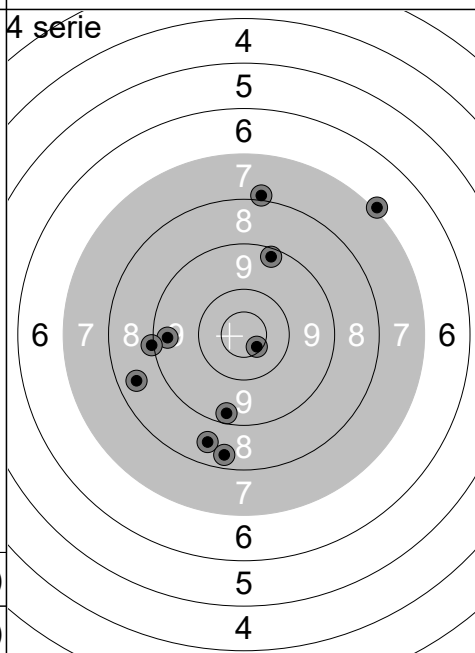

1:	9.4	←
2:	8.5	↙
3:	9.3	↓
4:	7.0	↗
5:	8.0	↑
6:	9.0	←
7:	8.6	↓
8:	10.6x	↘
9:	9.2	↑
10:	8.4	↓
Serie	85	(1x)
Total	340	(5x)

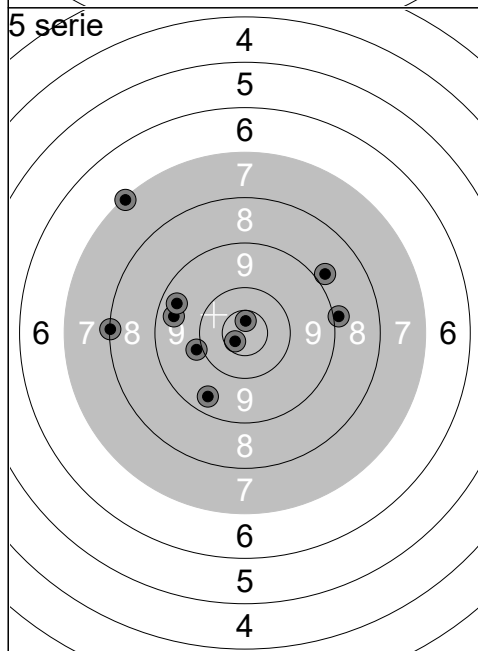

1:	10.7x	↑
2:	9.0	→
3:	9.4	←
4:	8.9	↗
5:	8.1	←
6:	9.4	↙
7:	10.7x	↙
8:	9.9	←
9:	7.1	↖
10:	9.4	↘
Serie	88	(2x)
Total	428	(7x)

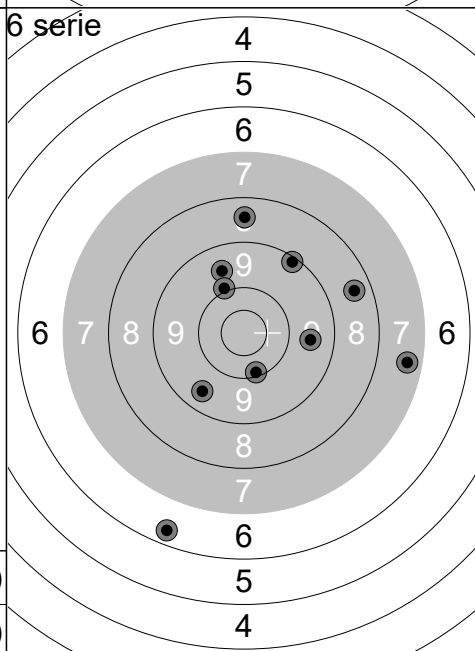

1:	9.5	↙
2:	10.1	↓
3:	8.4	→
4:	6.4	↘
5:	9.2	↗
6:	9.6	↑
7:	8.5	↑
8:	7.4	→
9:	9.6	→
10:	10.0	↖
Serie	85	(0x)
Total	513	(7x)

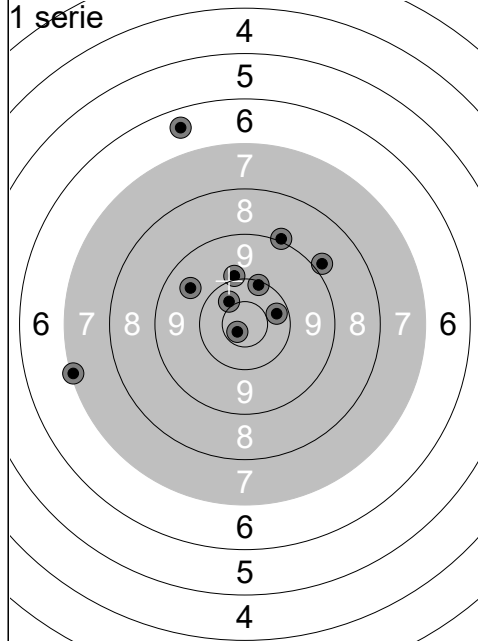

1:	10.1	↗
2:	10.7x	↙
3:	9.6	↖
4:	10.4	↗
5:	9.0	↗
6:	10.3	→
7:	6.5	↗
8:	8.9	↗
9:	7.1	↖
10:	10.0	↗
Serie		89 (1x)
Total		89 (1x)

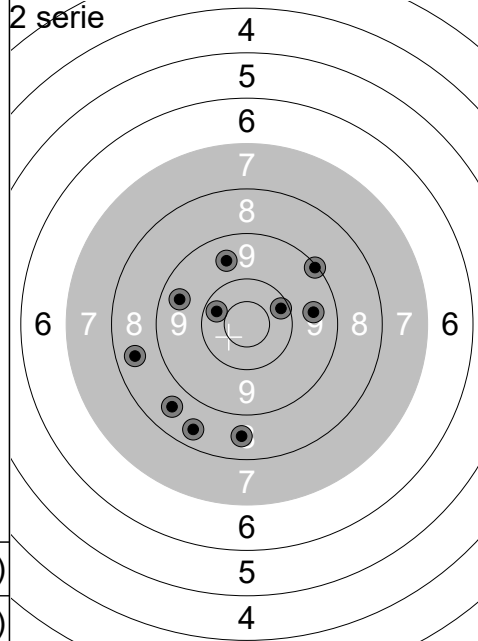

1:	10.2	→
2:	8.4	↙
3:	8.6	↓
4:	9.6	→
5:	9.5	↖
6:	8.6	↙
7:	10.3	↖
8:	8.5	↖
9:	9.1	↗
10:	9.6	↗
Serie		88 (0x)
Total		177 (1x)

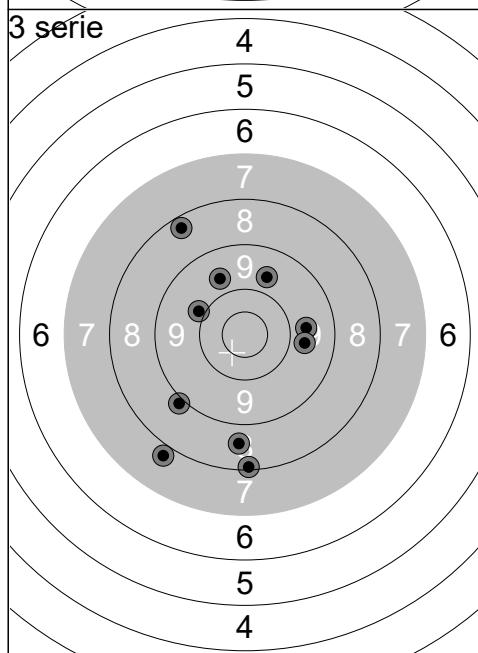

1:	9.0	↙
2:	9.9	↖
3:	8.3	↗
4:	9.7	↗
5:	9.7	↗
6:	7.8	↙
7:	8.6	↓
8:	9.7	→
9:	8.1	↓
10:	9.7	→
Serie		85 (0x)
Total		262 (1x)

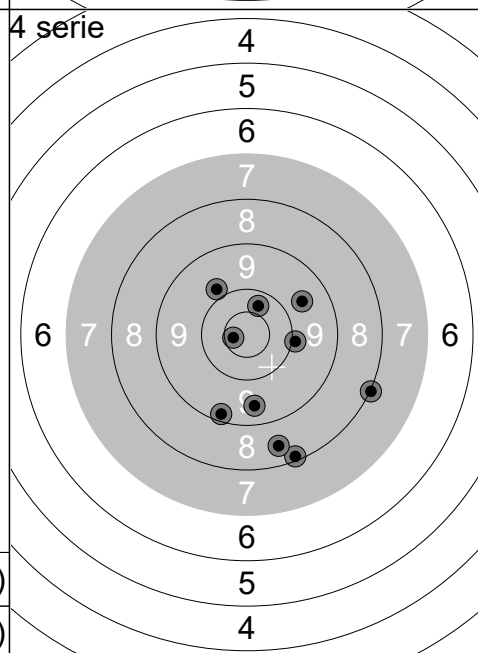

1:	9.6	↗
2:	10.7x	↖
3:	8.0	→
4:	8.2	↓
5:	9.9	↗
6:	9.2	↓
7:	10.3	↗
8:	8.5	↓
9:	9.5	↓
10:	10.0	→
Serie		90 (1x)
Total		352 (2x)

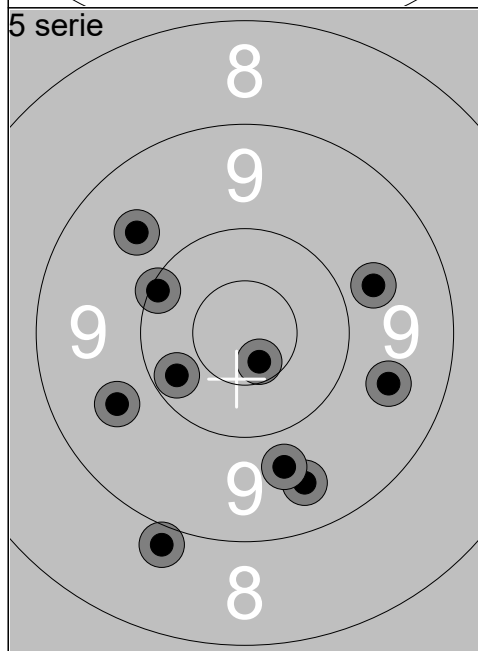

1:	9.7	↖
2:	9.6	↖
3:	9.5	↓
4:	10.3	↖
5:	10.1	↖
6:	9.7	↓
7:	9.7	→
8:	9.6	→
9:	8.9	↓
10:	10.7x	↙
Serie		92 (1x)
Total		444 (3x)

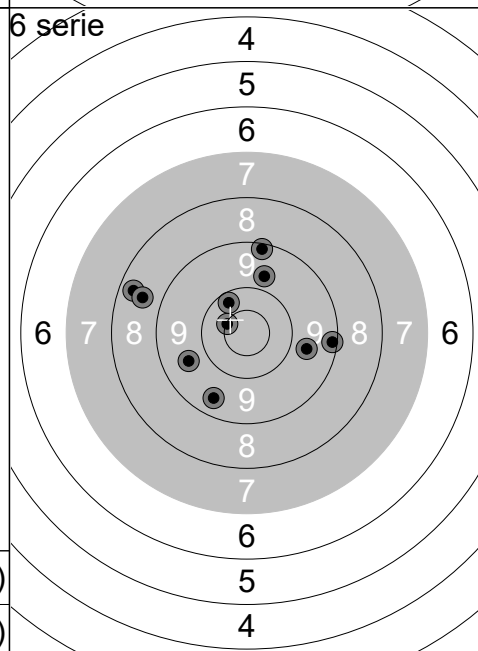

1:	9.7	→
2:	10.5x	↖
3:	9.6	↖
4:	9.2	↗
5:	9.8	↗
6:	8.4	↖
7:	9.4	↓
8:	9.2	→
9:	8.6	↖
10:	10.2	↗
Serie		90 (1x)
Total		534 (4x)

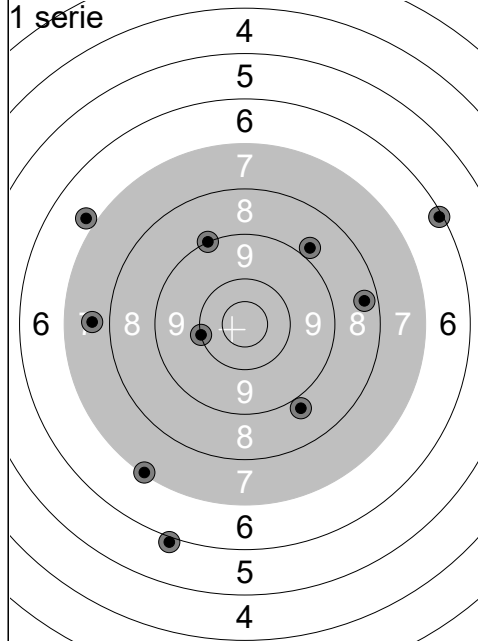

1:	7.7	←
2:	8.8	↗
3:	7.1	↘
4:	9.1	↗
5:	10.0	←
6:	8.4	→
7:	6.0	↘
8:	6.1	↗
9:	8.8	↘
10:	6.8	↖
Serie	75 (0x)	
Total	75 (0x)	

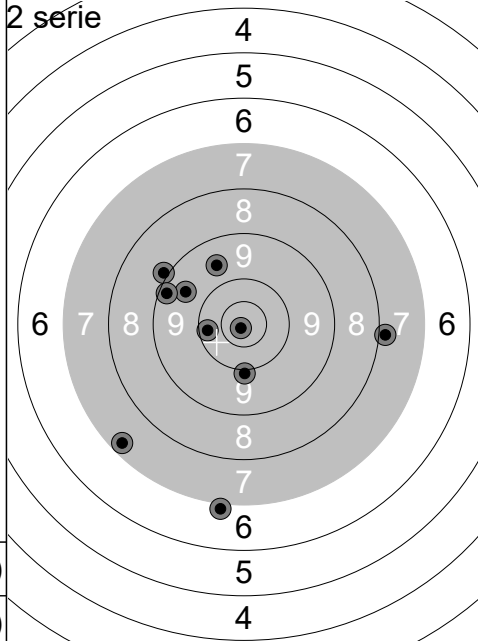

1:	6.9	↘
2:	8.9	↖
3:	9.6	↖
4:	10.0	↘
5:	9.6	↗
6:	7.9	→
7:	10.8x	↘
8:	10.2	←
9:	9.2	↖
10:	7.3	↘
Serie	85 (1x)	
Total	160 (1x)	

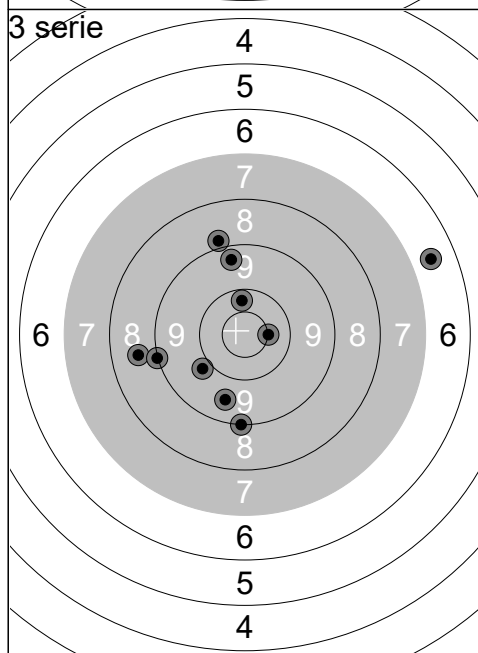

1:	9.1	↘
2:	9.4	↗
3:	6.6	→
4:	10.5x	→
5:	9.9	↖
6:	9.6	↘
7:	8.6	←
8:	9.0	←
9:	10.3	↗
10:	8.9	↗
Serie	87 (1x)	
Total	247 (2x)	

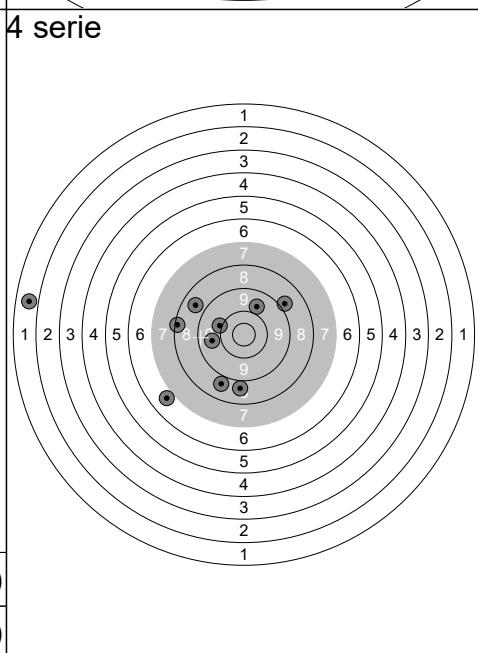

1:	1.6	←
2:	8.8	↗
3:	8.7	↘
4:	8.6	↖
5:	9.7	↗
6:	8.7	↘
7:	8.1	←
8:	9.6	←
9:	10.0	←
10:	6.7	↘
Serie	75 (0x)	
Total	322 (2x)	

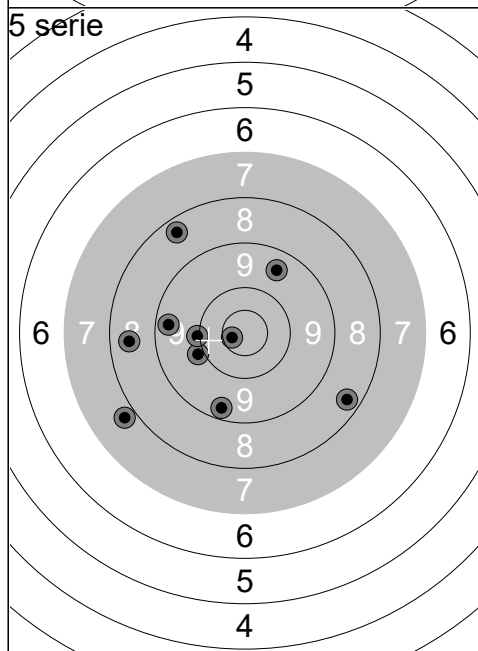

1:	9.9	←
2:	10.0	←
3:	8.5	←
4:	9.5	↗
5:	8.4	↘
6:	8.4	↗
7:	10.7x	←
8:	7.8	←
9:	9.3	↘
10:	9.3	←
Serie	87 (1x)	
Total	409 (3x)	

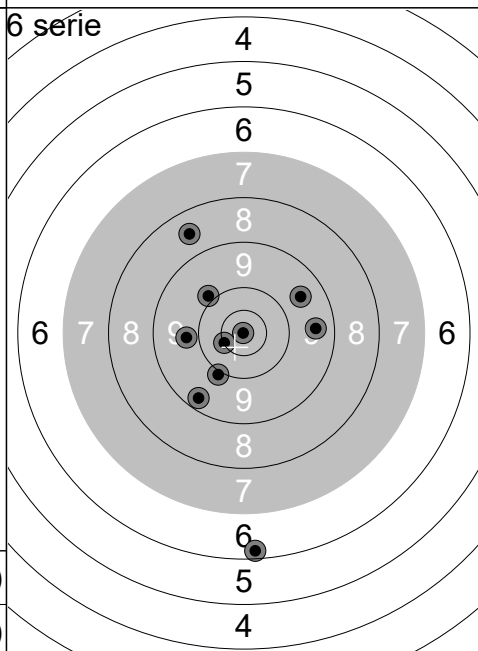

1:	9.6	↗
2:	10.9x	←
3:	10.5x	↖
4:	9.9	↖
5:	10.0	↘
6:	9.5	→
7:	9.3	↘
8:	8.6	↗
9:	9.8	←
10:	6.2	↘
Serie	89 (2x)	
Total	498 (5x)	

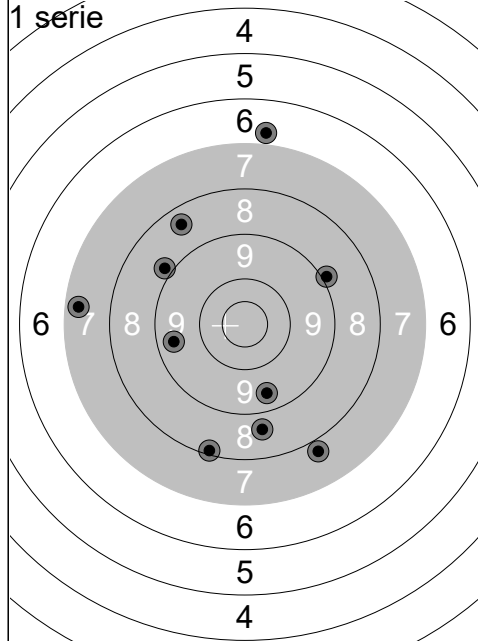

1:	7.4	←
2:	8.4	↗
3:	9.4	←
4:	7.8	↘
5:	9.0	↗
6:	8.2	↘
7:	8.9	↖
8:	9.5	↘
9:	8.7	↘
10:	6.8	↑
Serie		79 (0x)
Total		79 (0x)

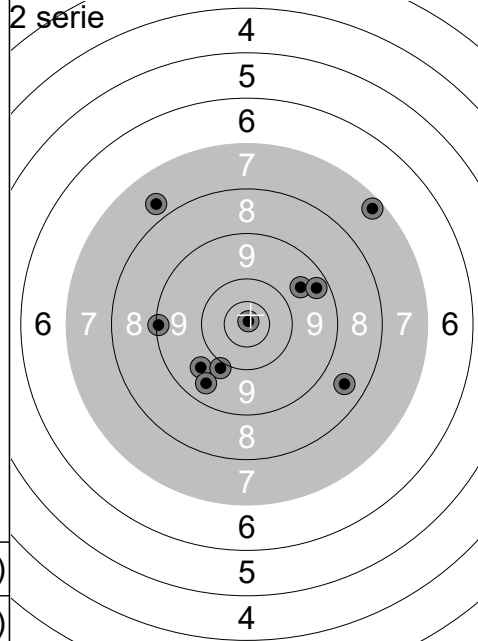

1:	8.5	↘
2:	7.3	↗
3:	7.7	↖
4:	10.9x	↗
5:	9.7	↘
6:	9.9	↘
7:	9.5	↘
8:	9.6	↗
9:	9.1	←
10:	9.3	↗
Serie		86 (1x)
Total		165 (1x)

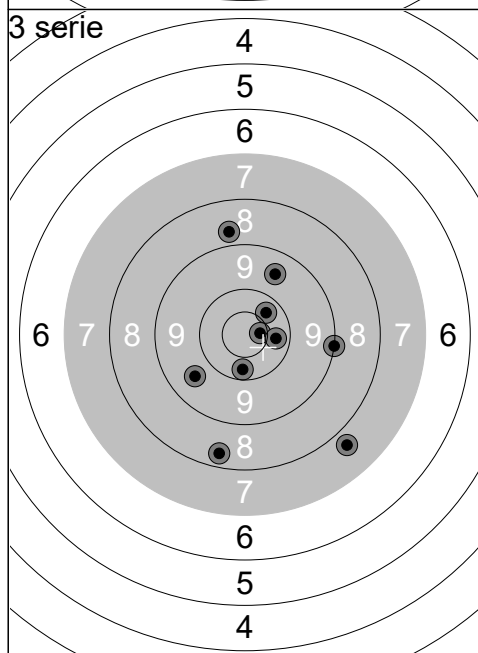

1:	10.3	↗
2:	9.6	↗
3:	8.7	↑
4:	10.3	↘
5:	7.7	↘
6:	9.6	↖
7:	10.6x	→
8:	8.4	↘
9:	9.1	→
10:	10.3	→
Serie		90 (1x)
Total		255 (2x)

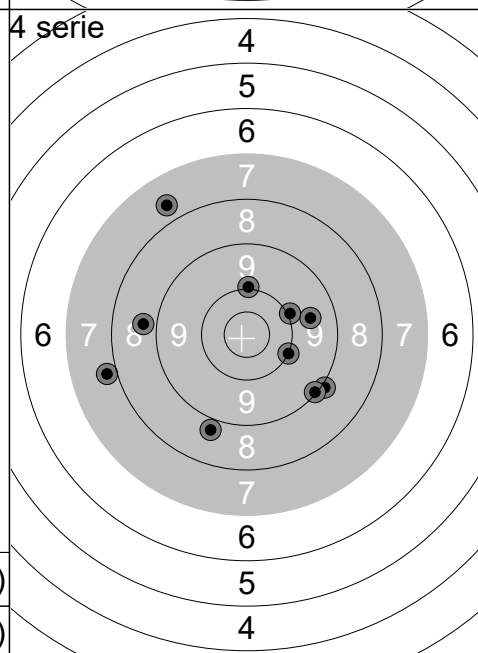

1:	9.6	→
2:	10.0	↗
3:	9.0	↘
4:	8.8	↘
5:	7.8	←
6:	10.0	→
7:	9.1	↘
8:	10.0	↑
9:	7.7	↖
10:	8.7	←
Serie		87 (0x)
Total		342 (2x)

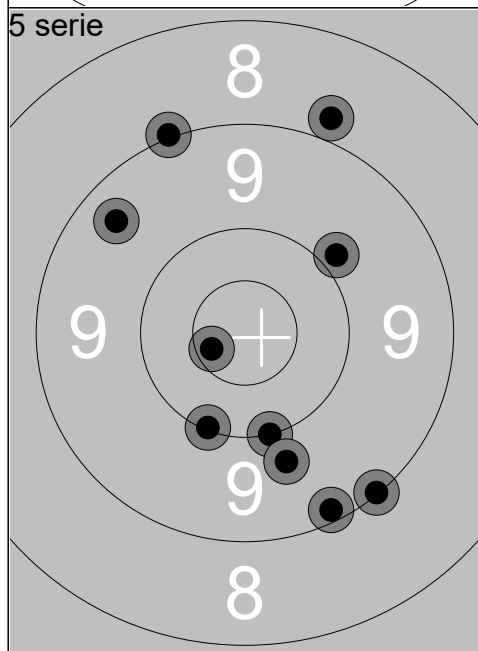

1:	10.0	↘
2:	9.0	↗
3:	10.6x	←
4:	9.4	↗
5:	9.8	↘
6:	9.1	↘
7:	10.1	↘
8:	9.9	↗
9:	8.8	↗
10:	9.2	↘
Serie		92 (1x)
Total		434 (3x)

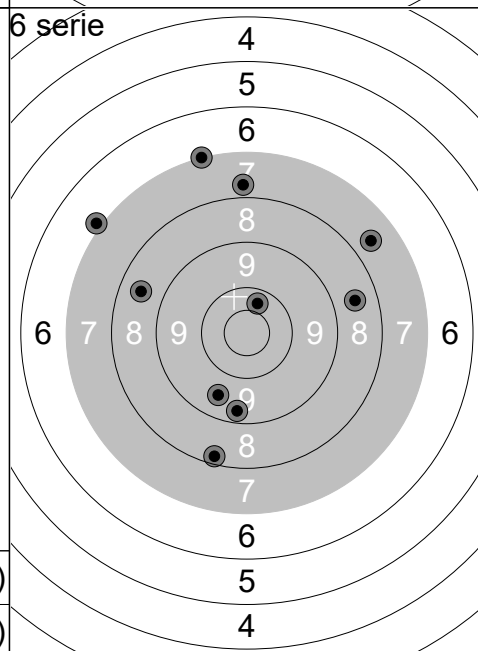

1:	10.3	↗
2:	7.6	↗
3:	6.9	↖
4:	8.6	←
5:	9.3	↘
6:	7.8	↑
7:	9.5	↘
8:	8.2	↘
9:	8.6	→
10:	7.1	↑
Serie		79 (0x)
Total		513 (3x)

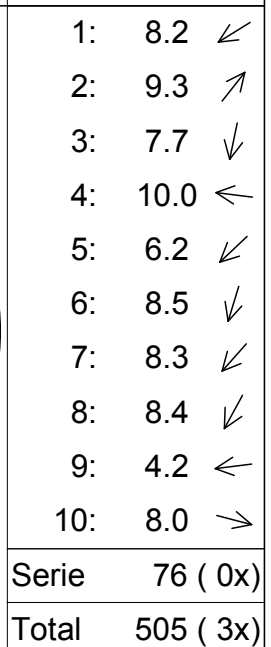
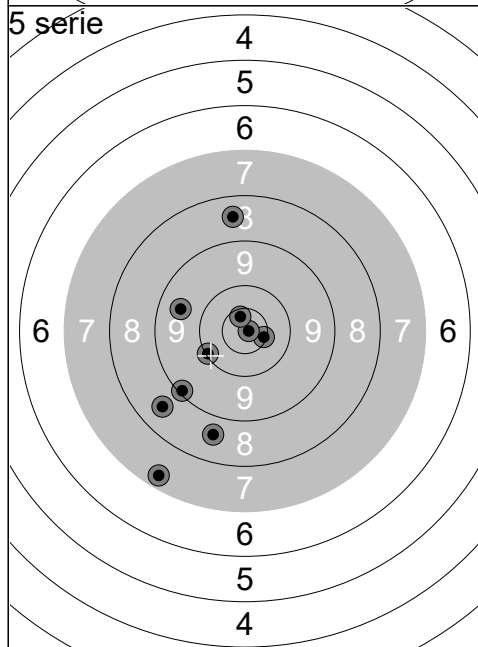
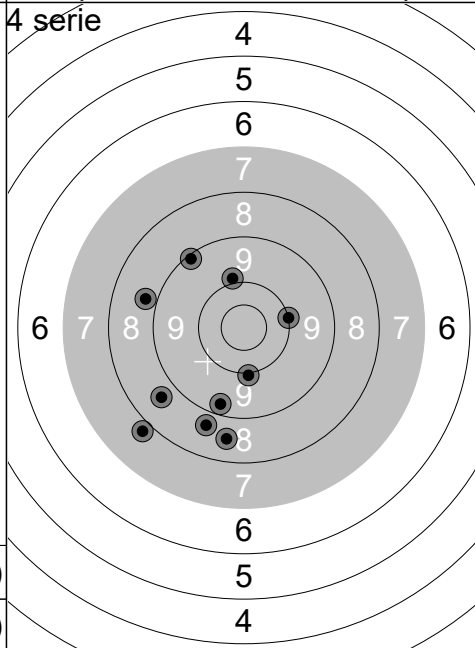
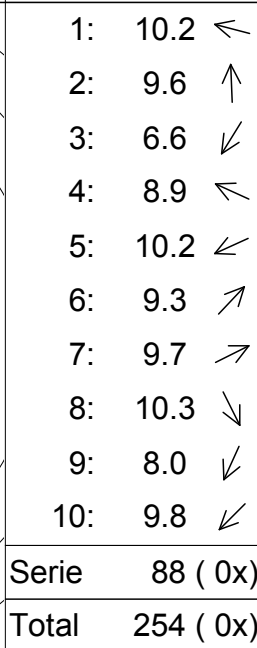
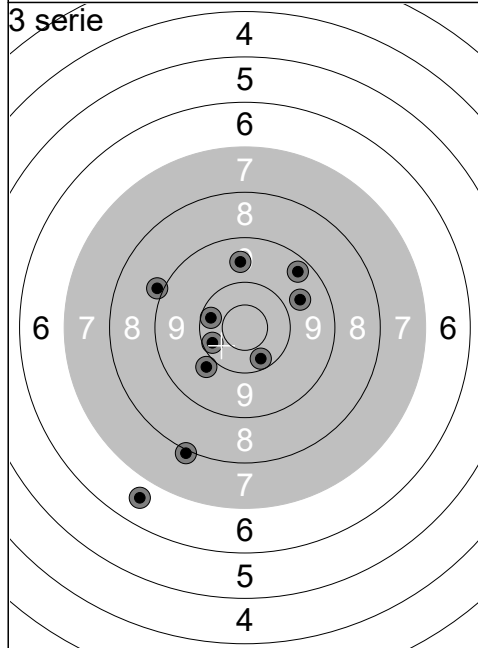
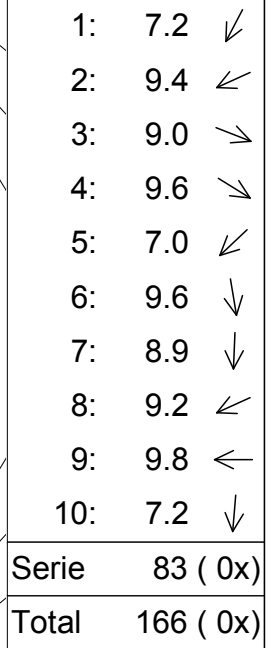
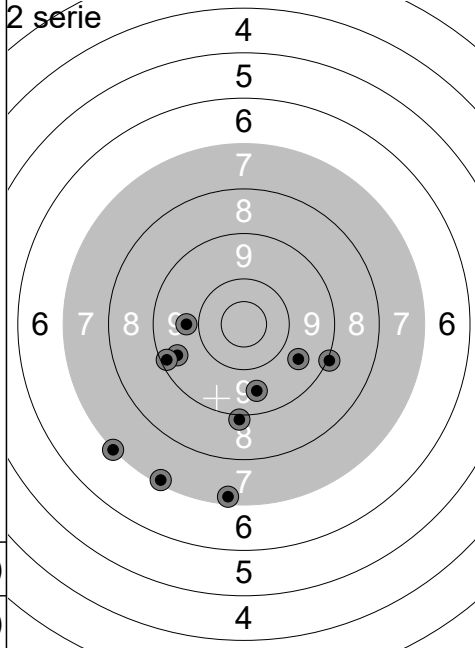
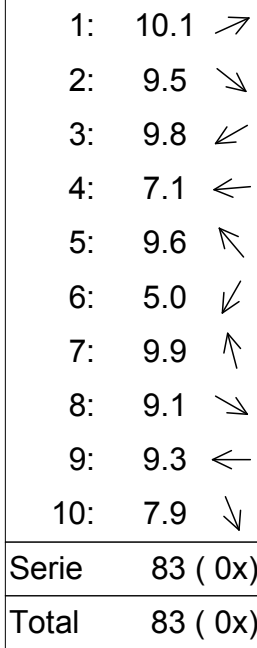
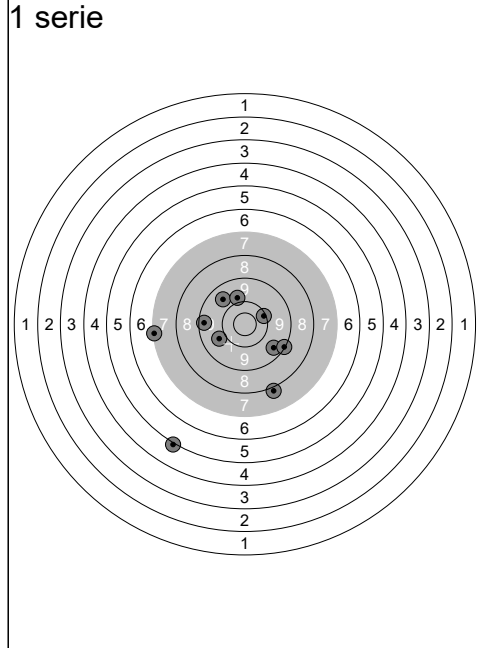

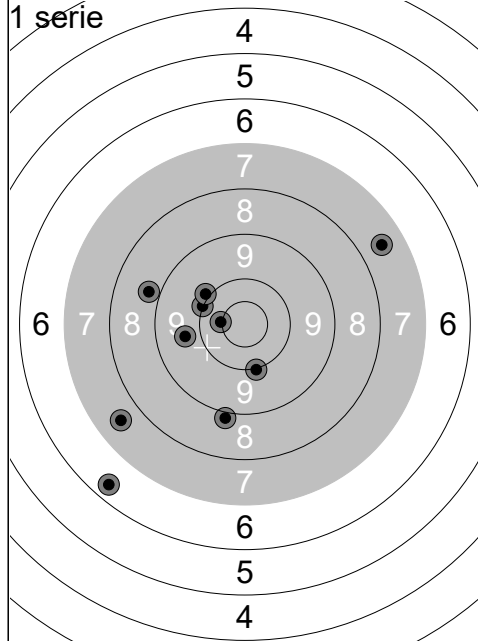

1:	10.0	↓
2:	10.5x	←
3:	8.8	←
4:	7.6	←
5:	6.4	↓
6:	10.0	←
7:	7.6	→
8:	10.0	↖
9:	8.9	↓
10:	9.7	←
Serie		85 (1x)
Total		85 (1x)

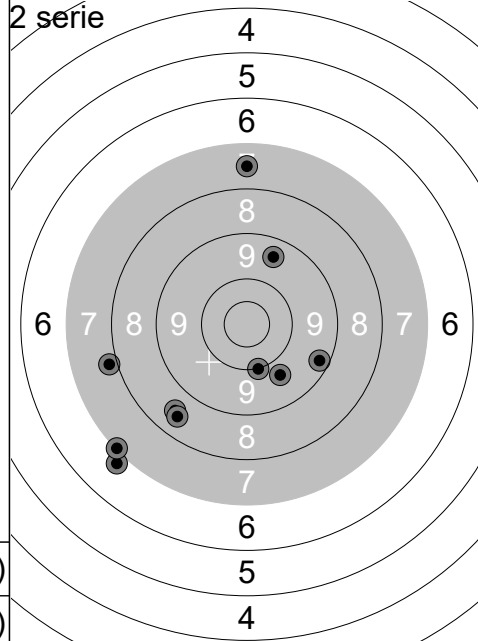

1:	9.5	↗
2:	8.6	↘
3:	6.8	↘
4:	9.7	↘
5:	10.0	↓
6:	7.1	↘
7:	8.5	↘
8:	7.6	↑
9:	9.3	↘
10:	7.9	←
Serie		80 (0x)
Total		165 (1x)

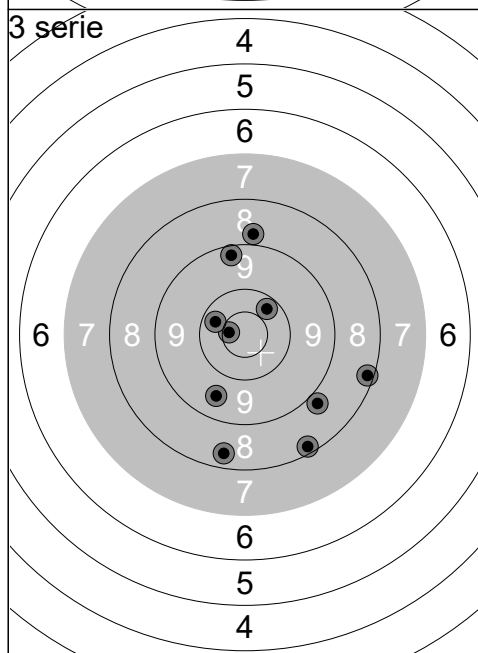

1:	8.4	↓
2:	9.3	↑
3:	8.8	↑
4:	10.6x	←
5:	8.2	↓
6:	10.3	↗
7:	8.8	↘
8:	10.3	←
9:	9.6	↓
10:	8.2	→
Serie		88 (1x)
Total		253 (2x)

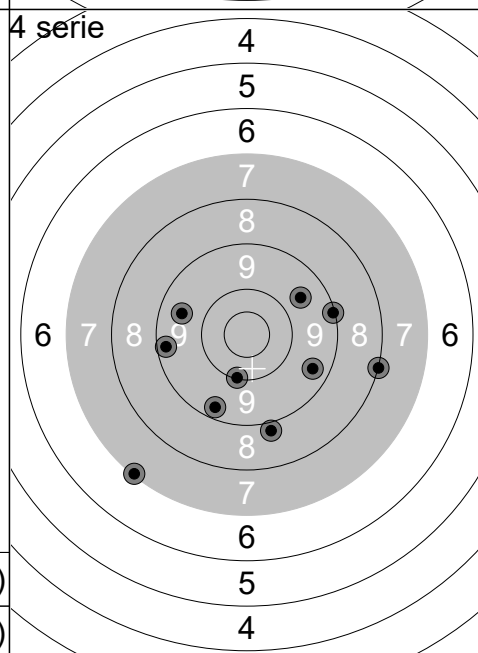

1:	7.1	↘
2:	9.5	←
3:	9.3	↘
4:	9.6	↗
5:	10.1	↓
6:	8.9	↘
7:	9.2	←
8:	8.1	→
9:	9.4	↘
10:	9.1	→
Serie		87 (0x)
Total		340 (2x)

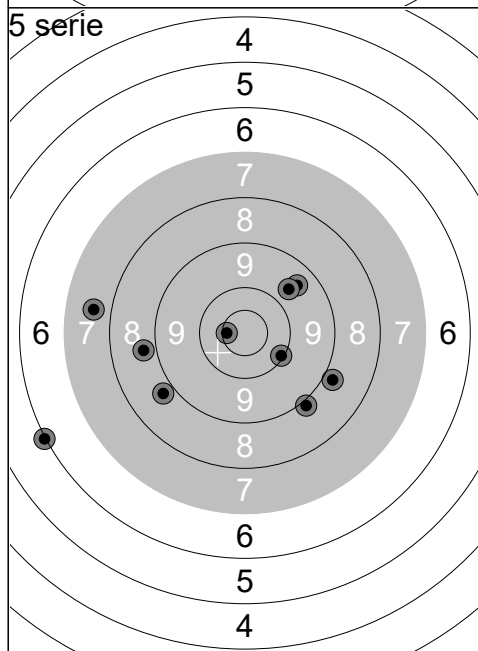

1:	8.9	↘
2:	7.7	←
3:	10.1	↘
4:	9.5	↗
5:	8.9	↘
6:	8.8	←
7:	6.0	←
8:	10.6x	←
9:	8.8	←
10:	9.7	↗
Serie		83 (1x)
Total		423 (3x)

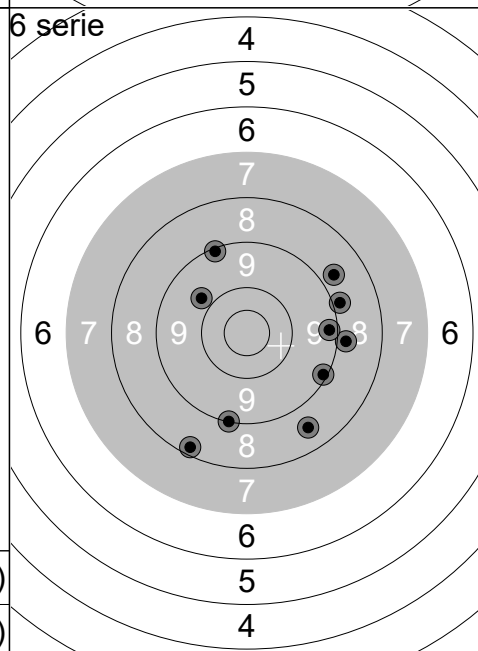

1:	8.9	→
2:	9.1	↘
3:	8.9	→
4:	9.2	→
5:	8.2	↘
6:	8.7	↗
7:	8.6	↘
8:	9.8	↗
9:	9.1	↑
10:	9.1	↓
Serie		85 (0x)
Total		508 (3x)

